

W5200E01-M3 User's Guide

Version 1.0

Table of Contents

1	Introduction	4
2	Specification.....	5
3	W5200E01-M3 Block Diagram	5
4	Hardware Layout.....	6
5	Expansion Port Interface	7
6	Development environment.....	8
6.1	IDE	8
6.2	Flash loader Demonstrator	8
6.3	USB-to-UART interface IC.....	8
7	W5200 SPI	9
8	W5200 Memory Map	12
9	Reference Firmware.....	13
9.1	W5200 Socket API	14
9.2	Firmware Structure	16
9.3	Firmware Functions.....	17
9.4	Firmware Build and Upload	18
9.4.1	Build - IAR Embedded Workbench IDE	18
9.4.2	Upload - Flash Loader Demonstrator	19
10	Application Demonstration.....	22
10.1	Flow of Demonstration	22
10.2	App. TEST.....	23
11	Physical Specification	25
12	Schematic	26

Table of Figures

Figure 1 W5200E01-M3 Block Diagram	5
Figure 2 W5200E01-M3 Layout.....	6
Figure 3 Download Flash loader demonstrator.....	8
Figure 4 Currently Supported VCP Drivers (3MAR2010).....	9
Figure 5 W5200 SPI Interface.....	9
Figure 6 W5200 Memory Map	12
Figure 7 TCP SERVER /CLIENT	13
Figure 8 Compile on IAR Embedded Workbench IDE.....	18
Figure 9 Flow Chat of Demonstration.....	22
Figure 10 W5200E01-M3 Board Dimension	25

1 Introduction

W5200E01-M3 is the evaluation board for testing iEthernet W5200 and prototyping development. W5200E01-M3 is composed of a STM32F103C8 based on ARM Cortex M3 CPU core, a W5200 which acts as Hardwired TCP/IP embedded Ethernet controller, and a FT232R which acts as USB-to-UART interface IC. W5200 has been proven in various fields to work as a fully hardwired TCP/IP implemented chip that processes various protocols such as TCP, UDP, IPv4, ICMP, ARP, IGMP, PPPoE, and etc.

Cortex-M3 can be used to test W5200's performance, and the surrounding peripherals can be used to implement various Ethernet Applications. The USB-to-UART interface IC in W5200E01-M3 can be used instead of a DB9 connector for UART communication. And the extension pin header (total of 40 pins) allows the user for easy connection and testing.

W5200E01-M3 can provide simple example codes based on ANSI C to implement various internet application programs based on W5200. W5200 can be used as a small embedded device in Power down mode to save power consumption.

Main features;

- W5200 Hardwired TCP/IPcore.
- RJ-45 which is integrated transformer.
- Cortex-M3.
- USB-to-UART interface IC.
- 40 pin expansion header.
- 2 user LEDs, 2 Serial TX/RX LEDs ,1 POWER Indicate LED
- Mode S/W, Reset S/W
- Power source : USB BUS power (500mA), External VIN (5V)

2 Specification

Table 1 List of Items Contained in the EVB

Item	Description	Remark
TCP/IP core	W5200	Hardwired TCP/IP core
MCU	Cortex-M3 MCU	STM32F103C8
USB-to-Serial Converter	On board USB-to-UART interface IC, USB bus power	FT232RQ
Ethernet	On board RJ-45 which is integrated transformer	-
LED	User LED 2Ea Serial Status LED 2Ea	-
Button	Reset Switch 1Ea Program Enable Switch 1Ea	-
Expansion Port	MCU port expansion - in 2.54mm Pitch Pin-Header Hole	-
PCB	28mm * 52mm Size	-

3 W5200E01-M3 Block Diagram

The Block diagram is shown below.

Figure 1 W5200E01-M3 Block Diagram

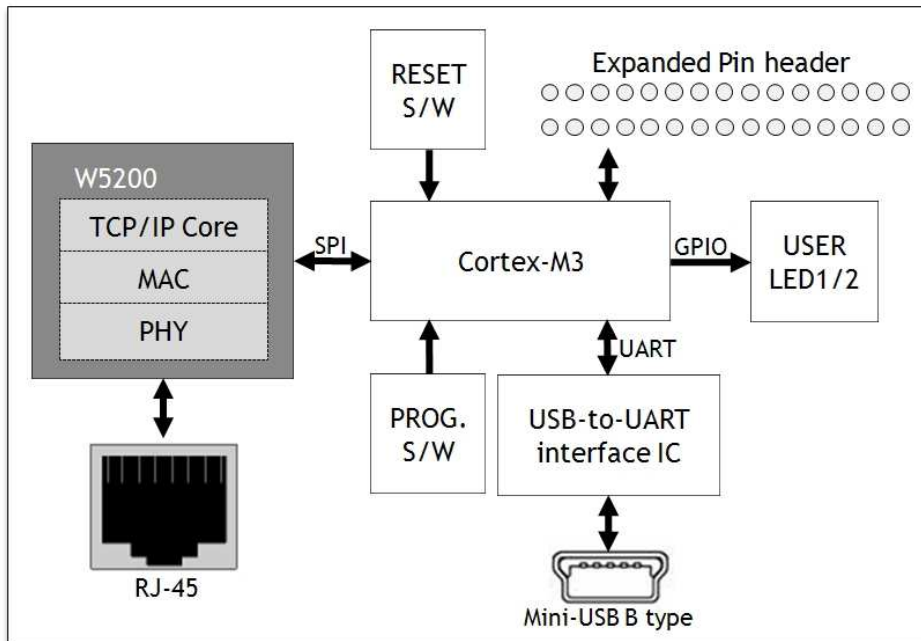

4 Hardware Layout

The layout of the W5200E01-M3 is shown below.

Figure 2 W5200E01-M3 Layout

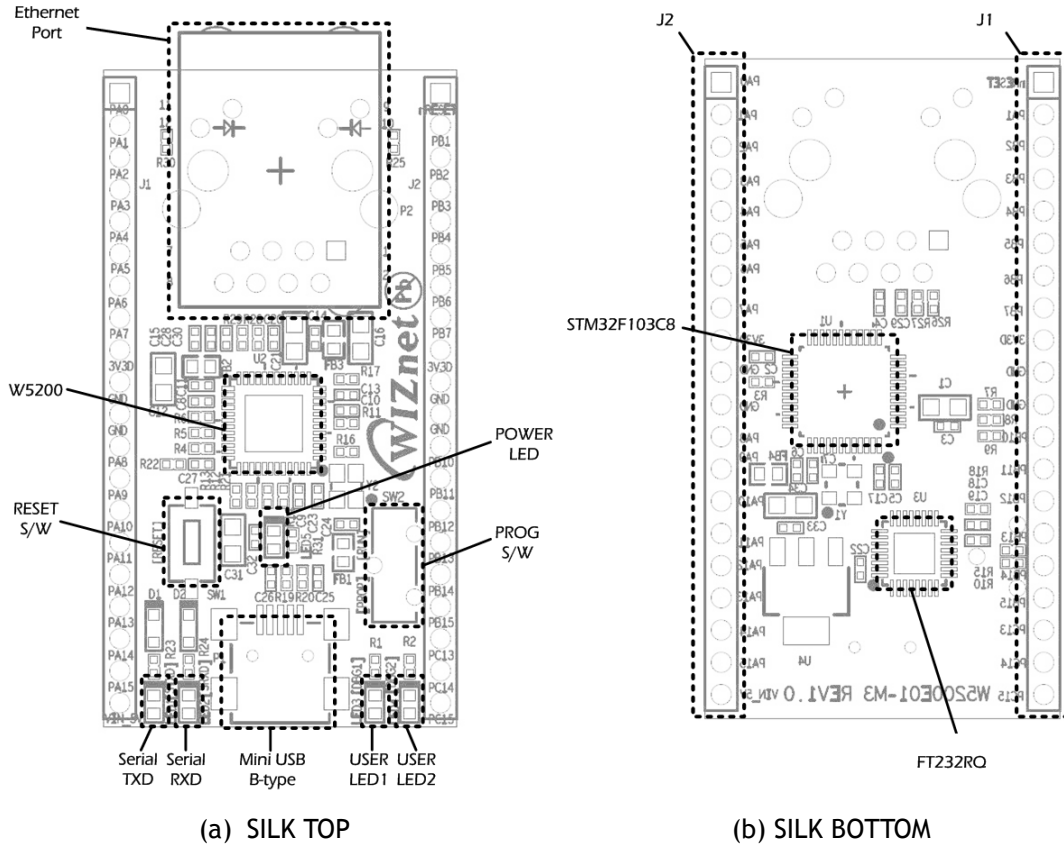

Table 2 Hardware Description

Symbols	Description	Symbols	Description
Ethernet Port	RJ-45 (integrated transformer)	User LED1 / User LED2	User LED 2Ea
RESET S/W	Reset Switch	STM32F103C8	Cortex-M3 MCU
PROG S/W	Enable Programming Switch - PROG: Program Enable - RUN: User APP. Enable	FT232RQ	USB-to-UART Interface IC
W5200	Hardwired TCP/IP Core	POWER LED	POWER Indicate LED
Serial TXD / Serial RXD	Serial status LED 2Ea	J1 / J2	20 Pin 2.54mm Pitch Expanded Headers
Mini USB B-type	USB Connector		

5 Expansion Port Interface

The expansion port has 2.54mm Pitch Pin-Header Hole.

Note.

1. Some of the expanded pin headers are shared by on board peripherals.
2. Refer to STM32F103C8's datasheet for more detailed information about alternative functions of pin header

Table 3 Expanded pin header

J1	Alternative Functions	Shared by	J2	Alternative Functions	Shared by
PA0	WKUP/UASRT2_CTS	LED3	nRESET	-	-
PA1	USART2_RTS/ADC12_IN1	LED4	PB1	ADC12_IN9/TIM3_CH4	-
PA2	USART2_TX/ADC12_IN2	-	PB2	-	BOOT1
PA3	USART2_RX/ADC12_IN3	-	PB3	-	-
PA4	SPI1_NSS/USART2_CK	nSS1	PB4	-	-
PA5	SPI1_SCK/ADC12_IN5	SCLK1	PB5	I2C1_SMBAL	-
PA6	SPI1_MISO/ADC12_IN6	MISO1	PB6	I2C1_SCL/TIM4_CH1	-
PA7	SPI1_MOSI/ADC12_IN7	MOSI1	PB7	I2C1_SDA/TIM4_CH2	-
3V3D	-	-	3V3D	-	-
GND	-	-	GND	-	-
GND	-	-	GND	-	-
PA8	USART1_CK/TIM1_CH1	TXD1	PB10	I2C2_SCL/USART3_TX	-
PA9	UART1_TX/TIM1_CH2	RXD1	PB11	I2C2_SDA/USAART3_RX	-
PA10	UART1_RX/TIM1_CH3	-	PB12	SPI2_NSS/I2C2_SMBAL	-
PA11	UART1_CTS/CANRX/	-	PB13	SPI2_SCK/USART3_CTS	-
PA12	UART1_RTS/CANTX	-	PB14	SPI2_MISO/USART3_RTS	-
PA13	-	-	PB15	SPI2_MISO/TIM1_CH3N	-
PA14	-	-	PC13	TAMPER-RTC	-
PA15	-	-	PC14	OSC32_IN	-
VIN_5V	External VIN (5V)	-	PC15	OSC32_OUT	-

6 Development environment

6.1 IDE

The IAR Embedded Workbench for ARM IDE is currently supported. (Other IDE tools for ARM IDE will be supported as like Keil.) The W5200E01-M3 software package is released the version of IAR Embedded Workbench for ARM 5.41. Refer to IAR's own documentation on how to use it. The W5200E01-M3 software package contains various examples for using W5200

6.2 Flash loader Demonstrator

Flash Loader demonstrator is used to program for W5200E01-M3.

Note:

Refer to UM0462 User manual at www.st.com for more detailed information about STM32F103xx Flash Loader demonstrator

- Download: UM0462 Flash loader demonstrator

<http://www.st.com/internet/mcu/product/216817.jsp>

Click "Design Support" -> SW DEMOS (Bottom end of page)

Figure 3 Download Flash loader demonstrator

SW DEMOS			
	Description	Version	Size
	STM32F101xx and STM32F103xx Flash loader demonstrator: Contains the Demo GUI, Command line and header source files	2.2.0	7867KB

6.3 USB-to-UART interface IC

When the mini-USB is connect to USB-equipped Windows computer, the Device Manager will properly installed USB-to-Serial driver. If USB-to-Serial adaptor not works as expected, you can download the USB-to-Serial driver at www.ftdichip.com.

Note:

Refer to Installation Guides at www.fuducguo.com more detailed information about USB-to-Serial converter.

- Download Installation Guides:

1. www.ftdichip.com
2. Click "Support->Documents-> Installation Guides"
3. Download up to your operation system.

- Download Driver
 1. www.ftdichip.com
 2. Click "Drivers->VCP Drivers"
 3. Download up to your operation system.

Figure 4 Currently Supported VCP Drivers (3MAR2010)

Operating System	Release Date	Processor Architecture						
		x86 (32-bit)	x64 (64-bit)	PPC	ARM	MIPSII	MIPSIV	SH4
Windows*	2011-02-28	2.08.12	2.08.12	-	-	-	-	-
Windows*	2010-08-11	2.08.02	2.08.02	-	-	-	-	-
Linux	2009-05-14	1.5.0	1.5.0	-	-	-	-	-
Mac OS X	2011-02-28	2.2.16	2.2.16	2.2.16	-	-	-	-
Windows CE 4.2-5.2**	2010-02-11	1.1.0.6	-	-	1.1.0.6	1.1.0.6	1.1.0.6	1.1.0.6
Windows CE 6.0	2010-02-11	1.1.0.6	-	-	1.1.0.6	1.1.0.6	1.1.0.6	1.1.0.6

7 W5200 SPI

The SPI Interface of ST23F103 with W5200 is shown below.

Figure 5 W5200 SPI Interface

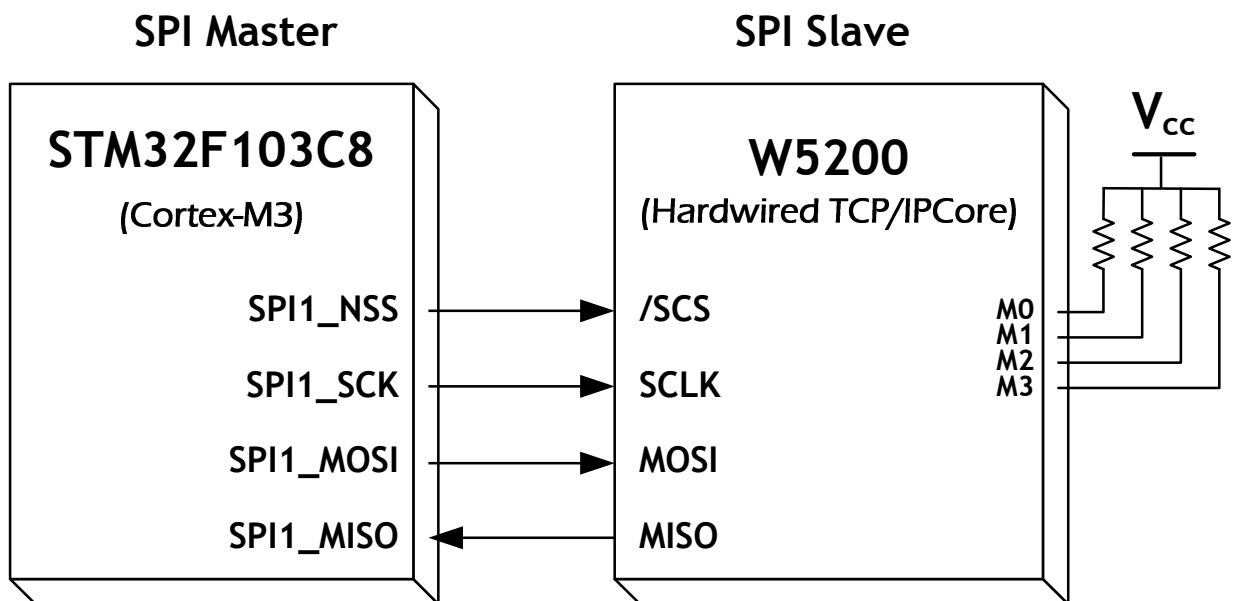

A pseudo code for read/write with SPI is shown below. Check the W5200 documentation for SPI burst mode, and how to use it.

Code 1 Pseudo code for Read with SPI interface

```

#define data_read_command  0x00

uint16 addr;    //address : 16bits
int16 data_len; //data_length :15bits
uint8 data_buf[]; // array for data
SpiSendData(); //send data from MCU to W5200
SpiRecvData(); //Receive data from W5200 to MCU

/* Pseudo Code for Read data of 8bit per packet */
{
ISR_DISABLE(); // Interrupt Service Routine disable
CSoff(); // CS=0, SPI start

//SpiSendData
SpiSendData(((addr+idx) & 0xFF00) >> 8); //Address byte 1
SpiSendData((addr+idx) & 0x00FF); //Address byte 2
// data write command + data length upper 7bits
SpiSendData((data_read_command | ((data_len & 0x7F00) >> 8)));
// data length bottom 8bits
SpiSendData((data_len & 0x00FF));

SpiSendData(0); //dummy data
data_buf[idx] = SpiRecvData(idx); //READ data

CSon(); // CS=1, SPI end
ISR_ENABLE();// Interrupt Service Routine disable
}
    
```

```

#define data_write_command  0x80

uint16 addr;    //address : 16bits
int16 data_len; //data_length :15bits
uint8 data_buf[]; // array for data
SpiSendData(); //send data from MCU to W5200
SpiRecvData(); //Receive data from W5200 to MCU

/* Pseudo Code for Read data of 8bit per packet */
{
SpiSendData(); //send data from MCU to W5200
ISR_DISABLE(); // Interrupt Service Routine disable
CSoff(); // CS=0, SPI start

SpiSendData(((addr+idx) & 0xFF00) >> 8); //Address byte 1
SpiSendData((addr+idx) & 0x00FF); //Address byte 2
// data write command + data length upper 7bits
SpiSendData((data_write_command | ((data_len & 0x7F00) >> 8)));
// data length bottom 8bits
SpiSendData((data_len & 0x00FF));
SpiSendData(data_buf[idx]);

CSon(); // CS=1, SPI end
IINCHIP_ISR_ENABLE(); // Interrupt Service Routine disable
}

```

8 W5200 Memory Map

Refer to W5200 Datasheet for more detail information.

Figure 6 W5200 Memory Map

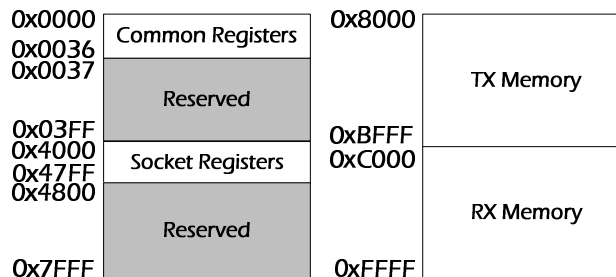

Table 4 W5200 Memory

Start Address	Register
0x0000	Mode (MR)
0x0001	Gateway Address (GAR[0-1])
0x0005	Subnet mask Address (SUBR[0-1])
0x0009	Source Hardware Address (SHAR[0-5])
0x000F	Source IP Address (SIPR[0-3])
0x0013	Reserved
0x0015	Interrupt (IR)
0x0016	Socket Interrupt Mask (IMR)
0x0017	Retry Time (RTR[0-1])
0x0019	Retry Count (RCR)
0x001A	Reserved
0x001C	Authentication Type in PPPoE (PATR[0-1])
0x001E	Authentication Algorithm in PPPoE (PPPALGO)
0x0020	Reserved
0x0028	PPP LCP Request Timer (PTIMER)
0x0029	PPP LCP Magic number (PMAGIC)
0x0030	Interrupt Low Level Timer (INTLEVEL[0-1])
0x0032	Reserved
0x0034	Socket Interrupt (IR2)
0x0035	PHY Status (PSTATUS)
0x0036	Interrupt Mask (IMR2)

Start Address	Register
0x4n00	Socketn Mode (SO_MR)
0x4n01	Socketn Command (SO_CR)
0x4n02	Socketn Interrupt (SO_IR)
0x4n03	Socketn Status (SO_SR)
0x4n04	Socketn Source Port (SO_PORT[0-1])
0x4n06	Socketn Destination Hardware Address (Sn_DHAR[0-5])
0x4n0C	Socketn Destination IP Address (Sn_DIPR[0-3])
0x4n10	Socketn Destination Port (Sn_DPORT[0-1])
0x4n12	Socketn Maximum Segment Size (Sn_MSS[0-1])
0x4n14	Socketn Protocol in IP Raw mode (Sn_PROTO)
0x4n15	Socketn IP TOS (SO_TOS)
0x4n16	Socketn IP TTL (SO_TTL)
0x4n17	Reserved
0x4n1E	Receive Memory Size (Sn_RXMEM_SIZE)
0x4n1F	Transmit Memory Size (Sn_TXMEM_SIZE)
0x4n20	Socketn TX Free Size (Sn_TX_FS[0-1])
0x4n22	Socketn TX Read Pointer (Sn_TX_RD[0-1])
0x4n24	Socketn TX Write Pointer (Sn_TX_WR[0-1])
0x4n26	Socketn RX Received Size (Sn_RX_RS[0-1])
0x4n28	Socketn RX Read Pointer (Sn_RX_RD[0-1])
0x4n2A	Socketn RX Write Pointer (Sn_RX_WR[0-1])
0x4n2C	Socket Interrupt Mask (Sn_IMR)
0x4n2D	Fragment Offset in IP header (Sn_FRAG[0-1])
0x4n2F	Reserved
0x4n30	Reserved

n is socket number (0, 1, 2, 3, 4, 5, 6, 7)

9 Reference Firmware

- The TCP (Transmission Control Protocol) RFC 793 of IETF
- TCP Server / Client Loopback

The TCP protocol of W5200 supports both server mode and client mode, user can select one and use for its application. The difference between server mode and client mode are shown below.

Figure 7 TCP SERVER /CLIENT

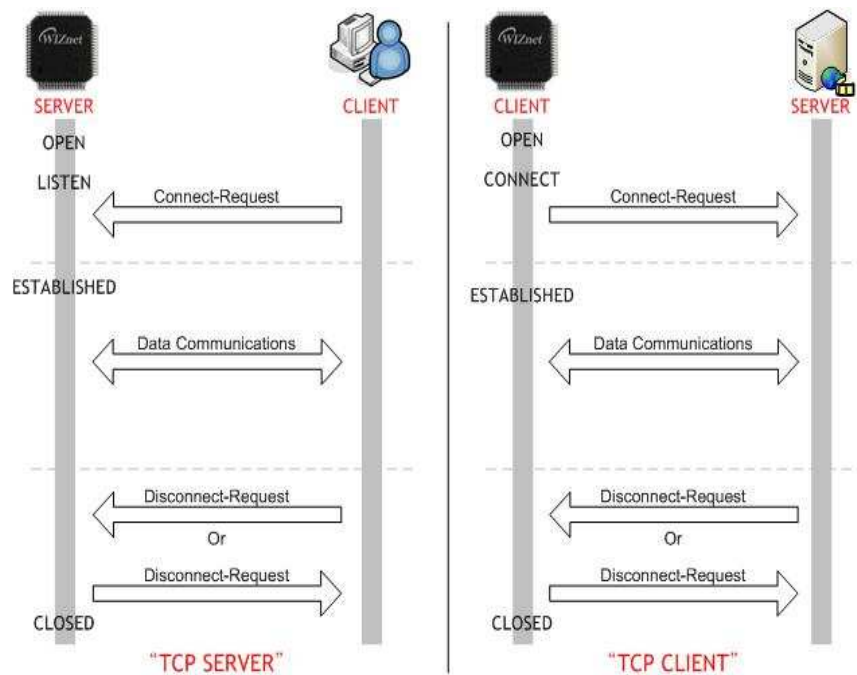

9.1 W5200 Socket API

Table 5 W5200 Socket API

Function	Description	Example code
socket()	To create the SOCKET n (the n-1 th SOCKET), use the socket() function to set the SOCKET number, protocol, port number, and flag.	Method 1 : server mode <pre> /* sets Protocol Number */ s = 0; // set SOCKET 0 (From 0 to 7) /* OPEN SOCKET 0 */ socket(s, Sn_MR_TCP, port, mode); while(getSn_SR(s) != SOCK_INIT); </pre>
		Method 2 : client mode <pre> /* sets Protocol Number */ s = 0; // set SOCKET 0 /* sets port number */ any_port = 1000; /* OPEN SOCKET 0 */ socket(s, Sn_MR_TCP, any_port++, mode); while(getSn_SR(s) != SOCK_INIT); </pre>
listen()	The LISTEN step is only used during SERVER mode. After creating the SOCKETn, change the SOCKET to LISTEN status so that CLIENT can connect.	<pre> s = 0; // set SOCKET 0 listen(s); </pre>
connect()	The CONNECT stage is used during CLIENT mode to connect to the SERVER.	<pre> s = 0; // set SOCKET 0 serverip[4] = {192, 168, 1, 2}; // set server(destination) IP serverport = 0x5000; set server(destination) port connect(s, serverip, serverport); </pre>
send()	In the case of TCP protocol, the connection between the peer is already complete before sending data	<pre> /* Send data to connected peer. */ // max_size_tx_buf must be smaller than the maximum size of the TX buffer s = 0; //set SOCKET 0 * data_buf[max_size_tx_buf] = (uint8 *)0x7000; // set position of data buffer len = 1460; //set length is 1460 Byte send(s, (uint8 *)data_buf, len); </pre>

receive()	RECEIVE is similar in usage method to SEND, but it has a checking the Sn_RX_RSR(n).	<pre> /* Check received data */ s = 0; //set SOCKET 0 /*len indicates the received data size in the RX buffer. It must be smaller than the maximum size of the RX buffer */ if ((len = getSn_RX_RSR(s)) > 0) /* Received data */ //len is a length included the DATA packet. * data_buf[max_size_tx_buf] = (uint8 *)0x7000; // set position of data buffer len = recv(s, (uint8 *)data_buf, len); </pre>
disconnect()	The disconnect (n) is not used to just directly close the SOCKET. It is used to send a disconnect-request (FIN packet) to a peer and wait for a disconnect-reply (FIN/ACK packet)	<pre> s = 0; // set SOCKET 0 disconnect(s); </pre>
close()	Unlike DISCONNECT, CLOSE directly changes the SOCKET to SOCK_CLOSED	<pre> s = 0; // set SOCKET 0 close(s); </pre>

9.2 Firmware Structure

Table 6 Project Hierarchy

Directory	Files	Decryption
USER	main.c	W5200E01-M3 main function
	W5200.c, W5200.h	I/O functions for W5200
	socket.c, socket.h	Socket APIs for W5200
	loopback.c, loopback.h	TCP, UDP Loopback Apps implementation
	SPI2.c	STM32F103x SPI Interface initialization
	util.c, util.h	Utilities
	dhcp.c, dhcp.h	DHCP App implementation
	md5.c, md5.h	md5 hash algorithm implementation for PPPoE
	stm32f10x_it.c	Main Interrupt Service Routines
	system_stm32f10x.c	Cortex-M3 Device Peripheral Access Layer System
CMSIS	core_cm3.c	Cortex™ Microcontroller Software Interface Standard
EWARMv5.4	startup_stm32f10x_md.s	STM32F10x Medium Density Devices vector table
EWARMv5.4/ StdPeriph_Driver	misc.c	miscellaneous firmware functions
	stm32f10x_bkp.c	BKP firmware functions
	stm32f10x_flash.c	FLASH firmware functions
	stm32f10x_gpio.c	GPIO firmware functions
	stm32f10x_rcc.c	RCC firmware functions
	stm32f10x_spi.c	SPI firmware functions
	stm32f10x_tim.c	TIM firmware functions
stm32f10xusart.c	USART firmware functions	

9.3 Firmware Functions

Table 7 Functions in main.c

Function	Description
RCC_Configuration	Configure the system clocks
NVIC_Configuration	Nested Vectored Interrupt Controller configuration
GPIO_Configuration	Configure the General Purpose I/O Pin
Reset_W5200	W5200 Reset Function
UART1_Init	UART Interface Initialization
WIZ_SPI_Init	W5200 SPI Interface Initialization
Timer_Configuration	Timer Configuration
LED3_onoff/LED4_onoff	USER LED n Control Function
Set_network	Configure Network In formations for W5200
WIZ_Config	Configure Network In formations

Table 8 Key Variables for Network Configuration

Variable	Description	Example Code (Location: main.c)
MAC[6]	MAC address	MAC[6] = {0x00, 0x08, 0xDC, 0x01, 0x02, 0x03};
IP[4]	Local IP address	IP[4] = {192, 168, 11, 4};
GateWay[4]	Gateway address	GateWay[4] = {192, 168, 11, 1};
SubNet[4]	Sub	SubNet[4] = {255, 255, 255, 0};

- Note : MAC address should be defined even if DHCP mode.

Table 9 Functions in Loopback.c

Function	Description	Example Code (Location: loopback.c)
loopback_tcps	TCP Loopback server mode	- ch : socket number [0-7] - port : source port loopback_tcps(uint8 ch, uint16 port)
loopback_tcpc	TCP Loopback client mode	- ch : socket number [0-7] - ChConfig.destip : Destination IP - ChConfig.port : Destination Port loopback_tcpc(uint8 ch, CHConfig_TypeDef* ChConfig)
loopback_udp	UDP (User Datagram Protocol) Loopback server mode	- ch : socket number [0-7] - port : source port loopback_udp(uint8 ch, uint16 port)

9.4 Firmware Build and Upload

9.4.1 Build - IAR Embedded Workbench IDE

To build and link your project choose "Make" from the "Project" menu, or press F7.

Figure 8 Compile on IAR Embedded Workbench IDE

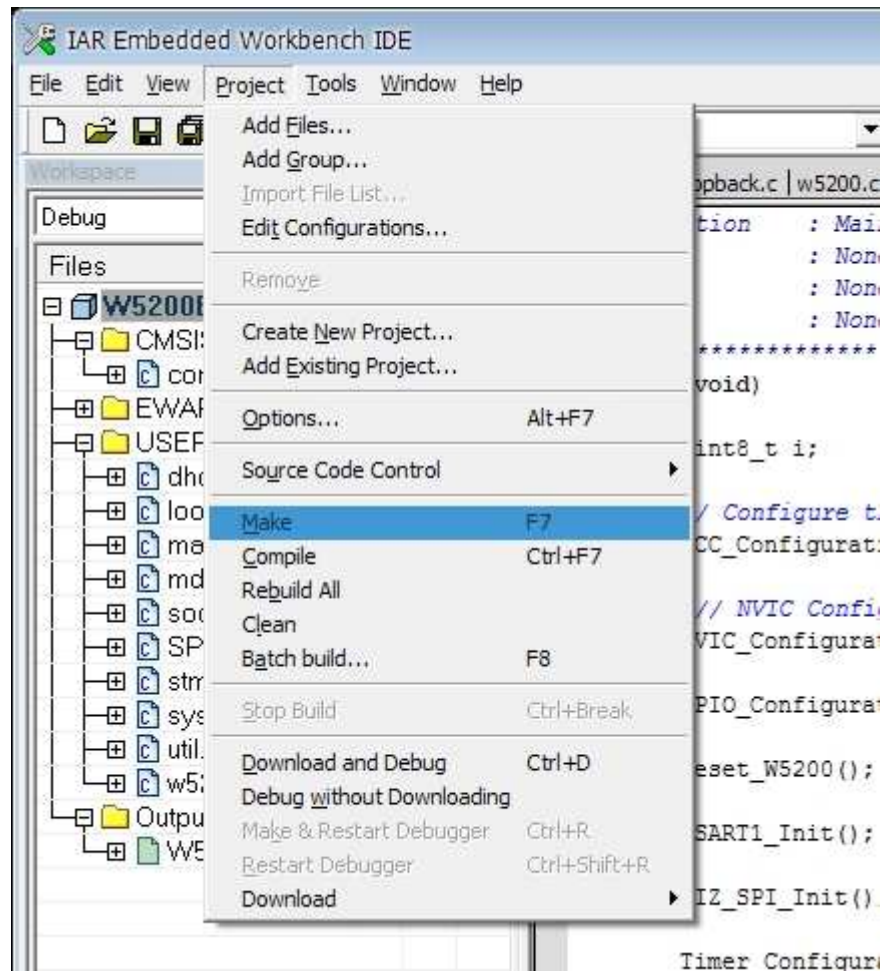

9.4.2 Upload - Flash Loader Demonstrator

Upload 1 Select the Communication port and set setting

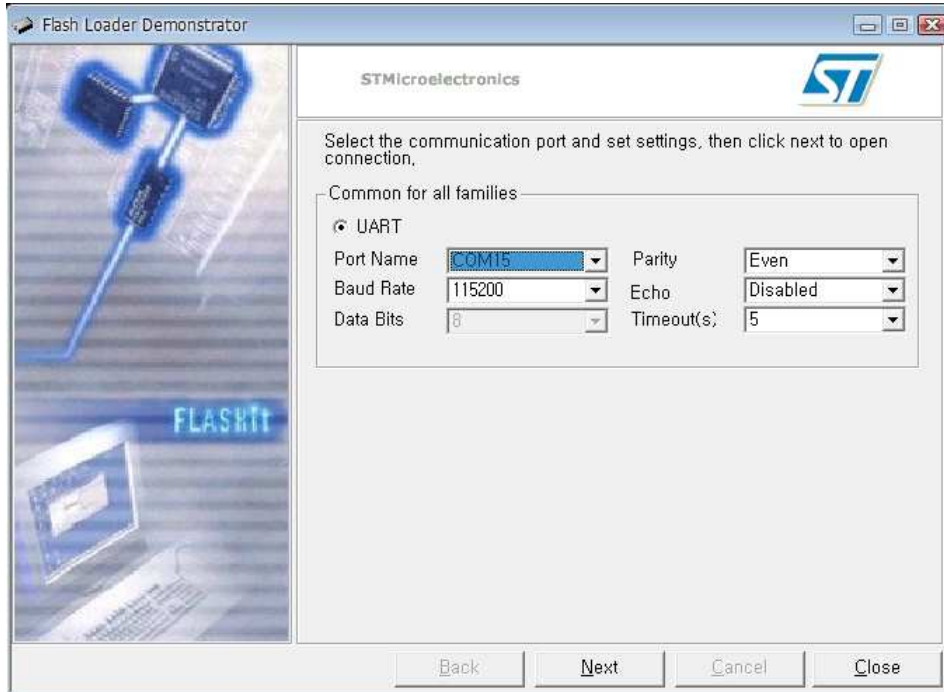

Note - PROG S/W should be selected 'PROG' to connect to W5200E01-M3 with PC.

Upload 2 Check target readable

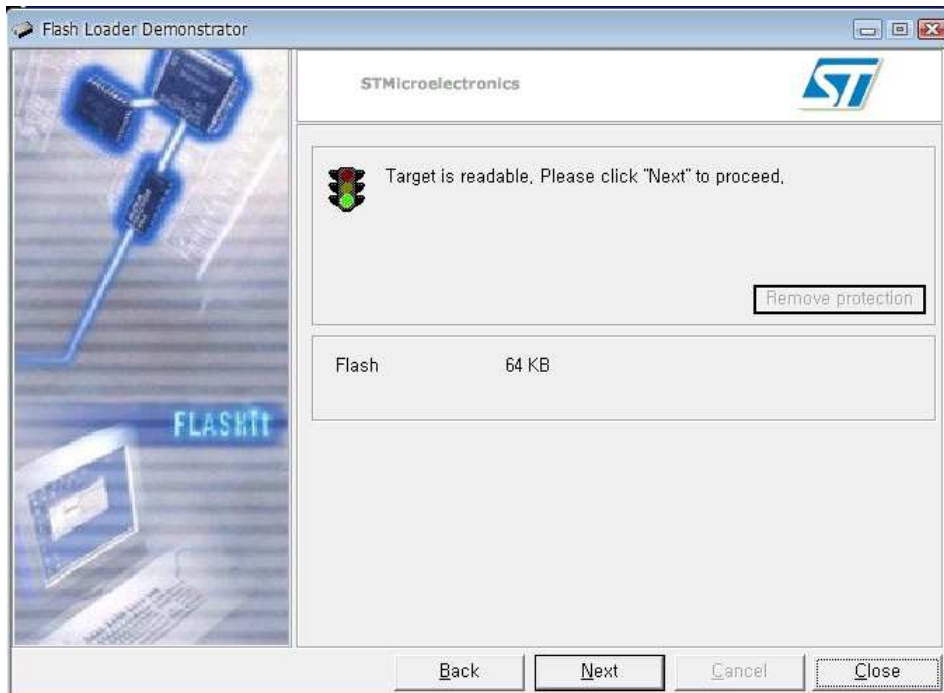

Upload 3 Select device in the target

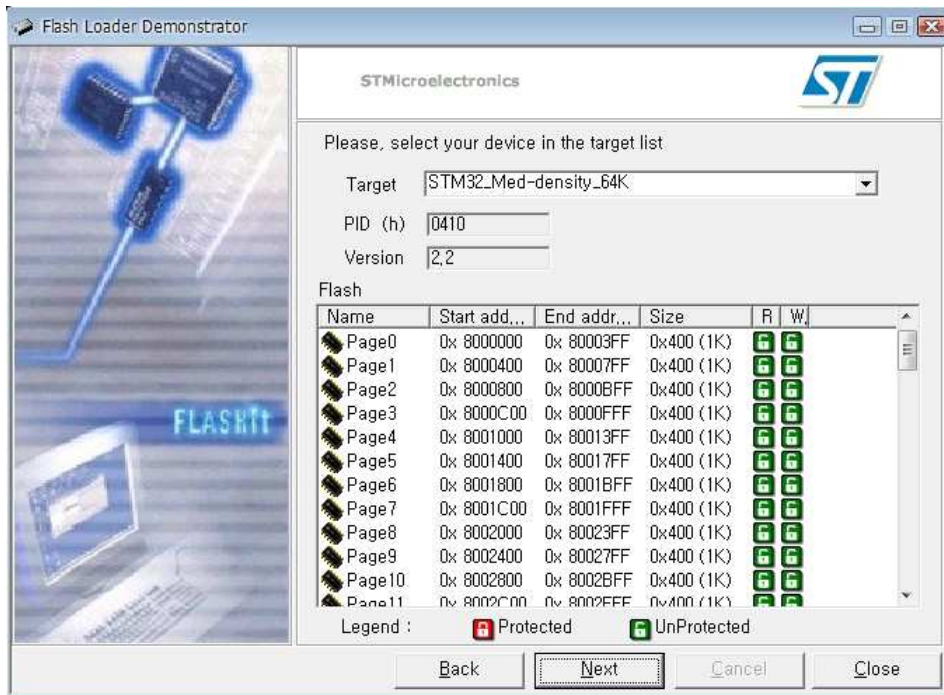

Upload 4 Choose Binary image file in work project

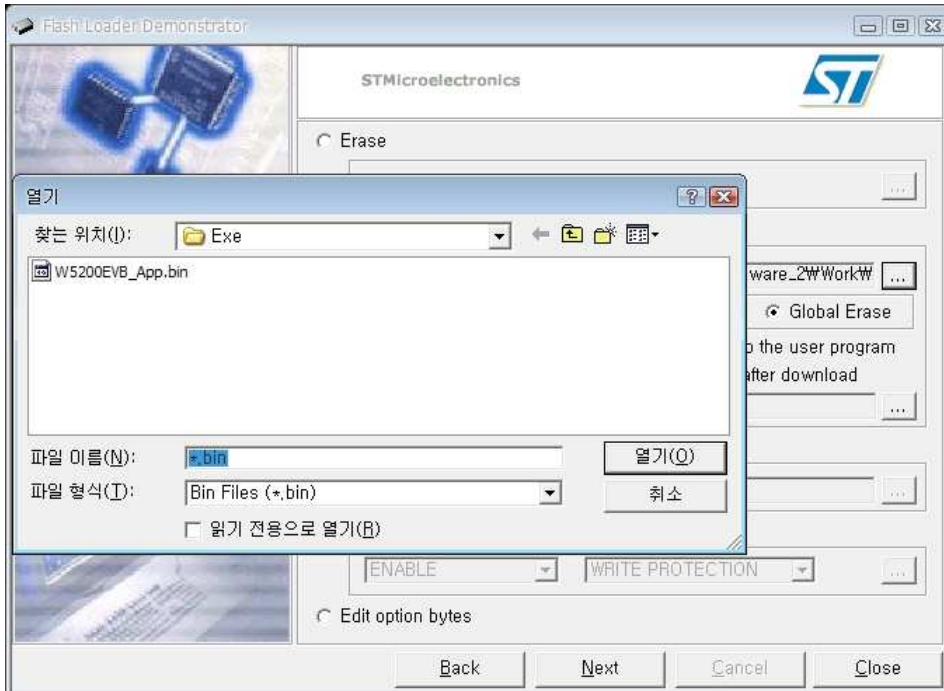

Note - Binary image file's location: ...Work\App\Debug\Exe in project directory

Upload 5 Select "@0x08000000" in memory address list



Upload 6 Select "Next" to upload the binary image file

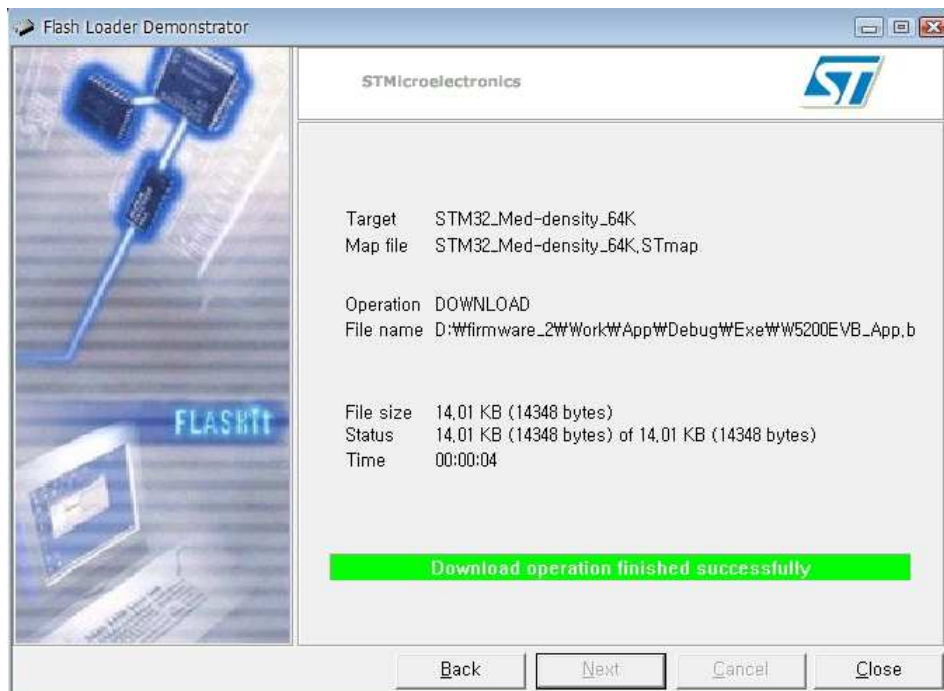

Note - After finishing 'Download', PROG S/W should be selected 'RUN' to run User APP.

10 Application Demonstration

10.1 Flow of Demonstration

Figure 9 Flow Chat of Demonstration

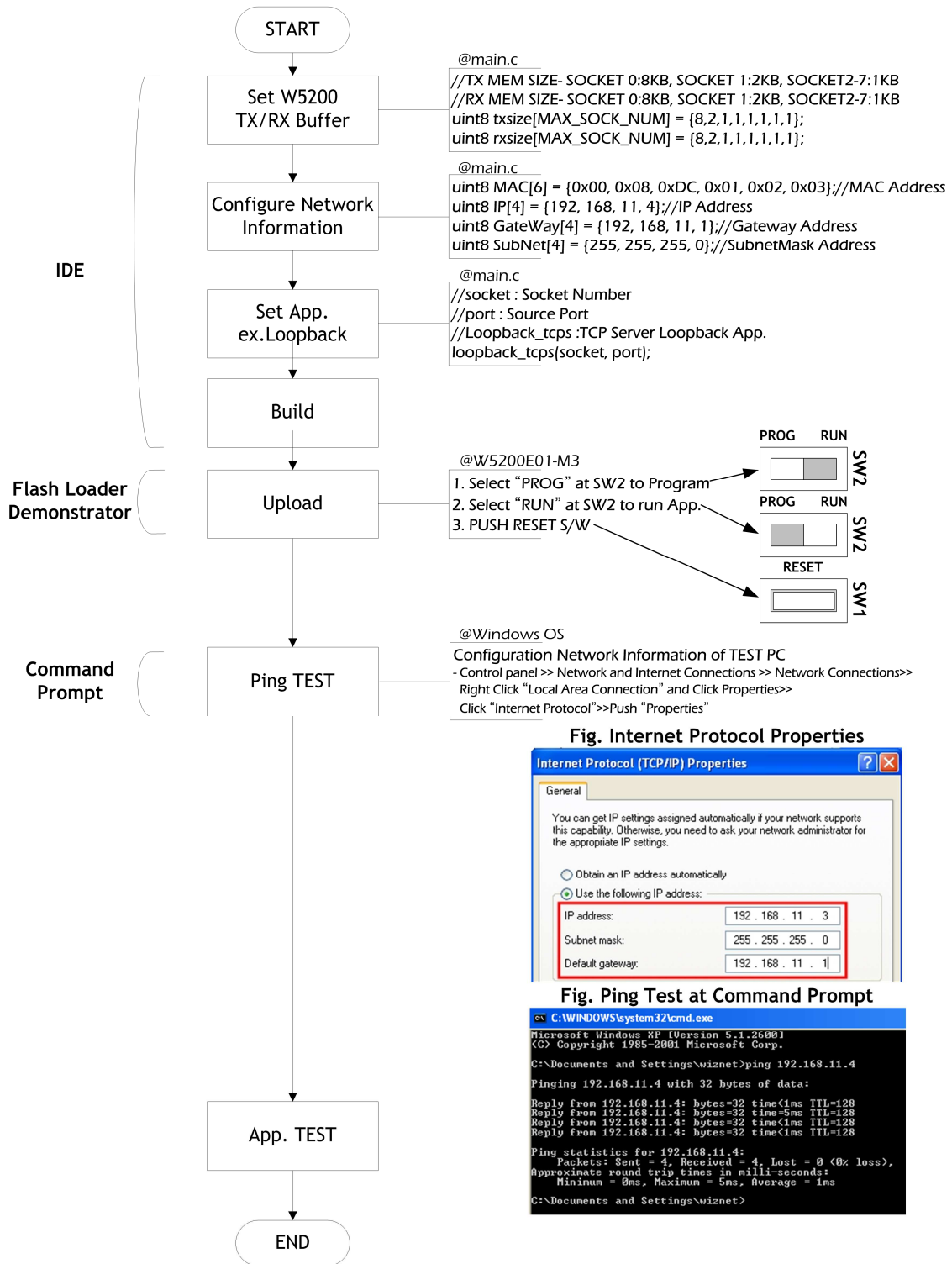

Fig. Internet Protocol Properties

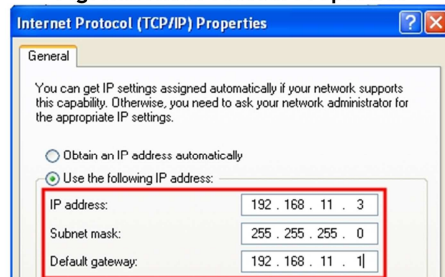
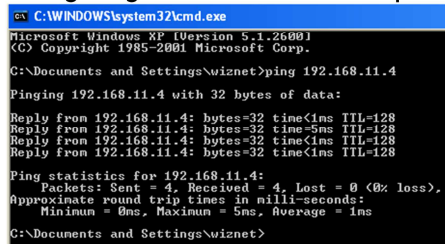

Fig. Ping Test at Command Prompt



10.2 App. TEST

- AX1 : Loopback test program
- Download URL : http://www.wiznet.co.kr/UpLoad_Files/ReferenceFiles/AX1.zip
 - AX1.zip : AXInstallV3.1.exe, AX1 Manual V3.1.pdf

Run 1 Input W5200E01-M3 IP and Port

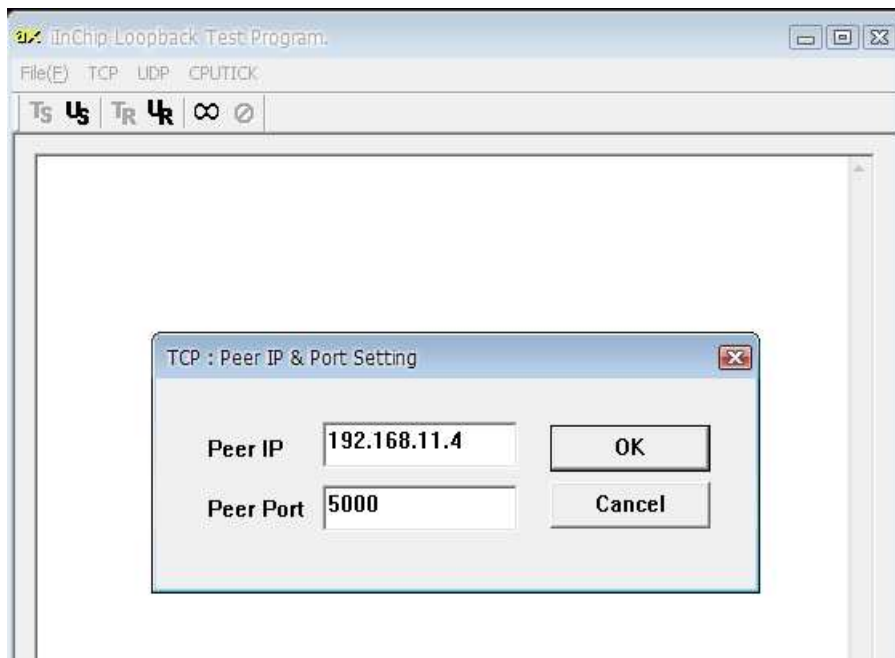

Run 2 Check "Connected" message

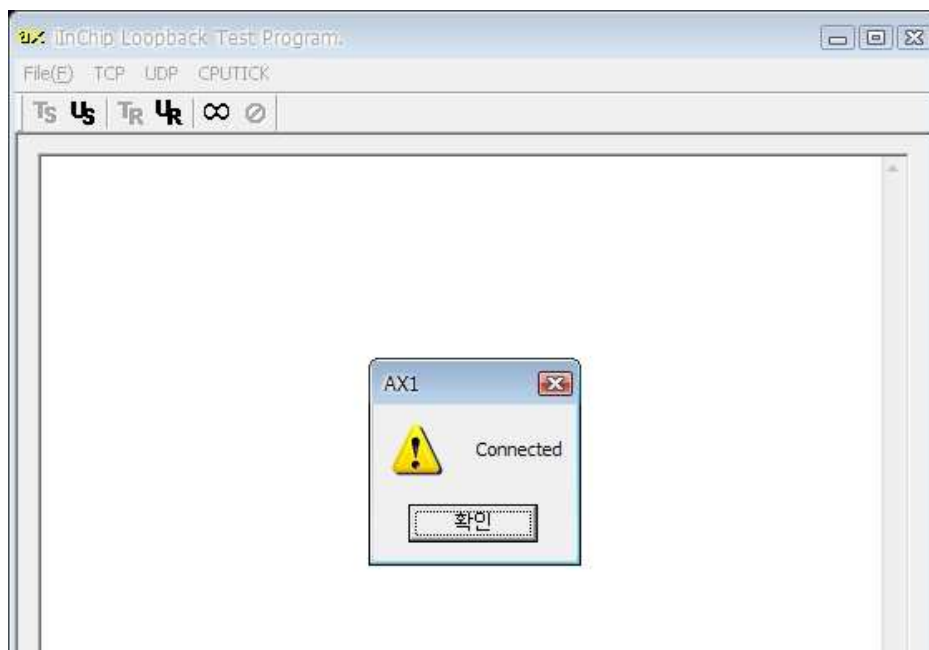

Run 3 Set Data format; size and base Value

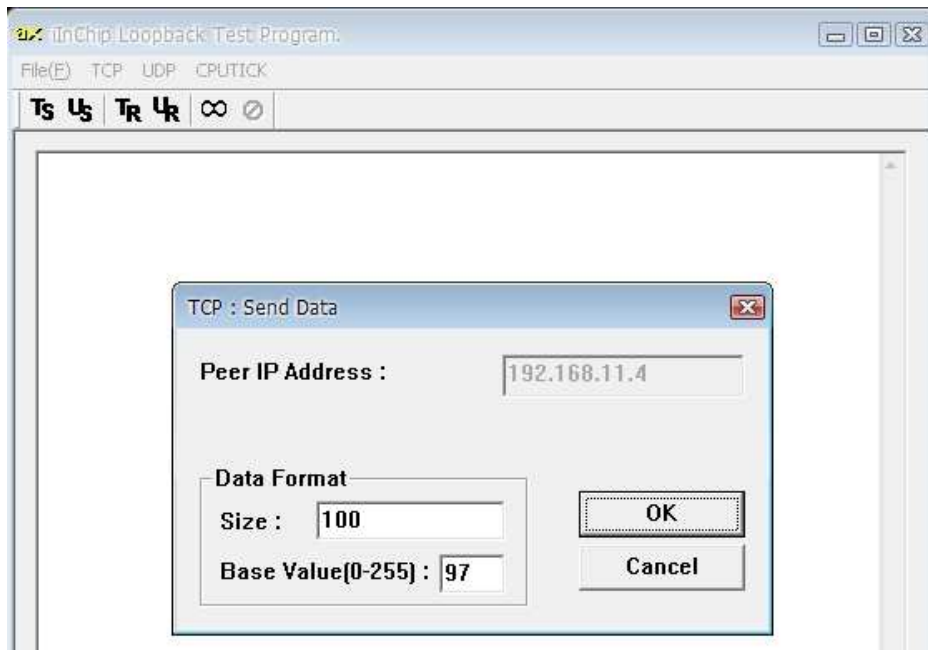

Run 4 Check the status message in dialog window

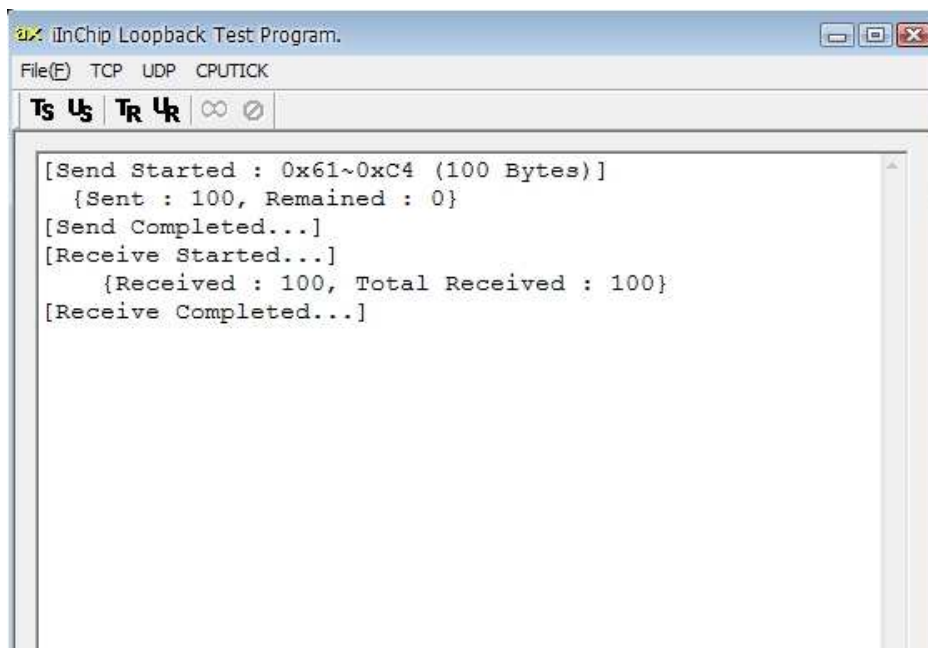

11 Physical Specification

Figure 10 W5200E01-M3 Board Dimension

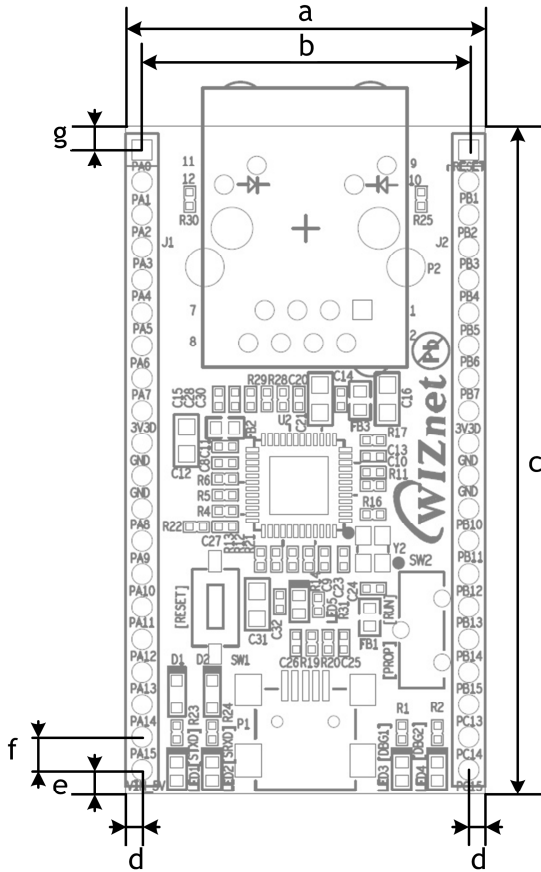

Symbols	Dimensions (mm)
a	28.00
b	25.40
c	52.00
d	1.30
e	1.87
f	2.54
g	1.87

12 Schematic

W5200E01-M3 Schematic can be downloading at WIZnet Homepage, www.wiznet.co.kr.

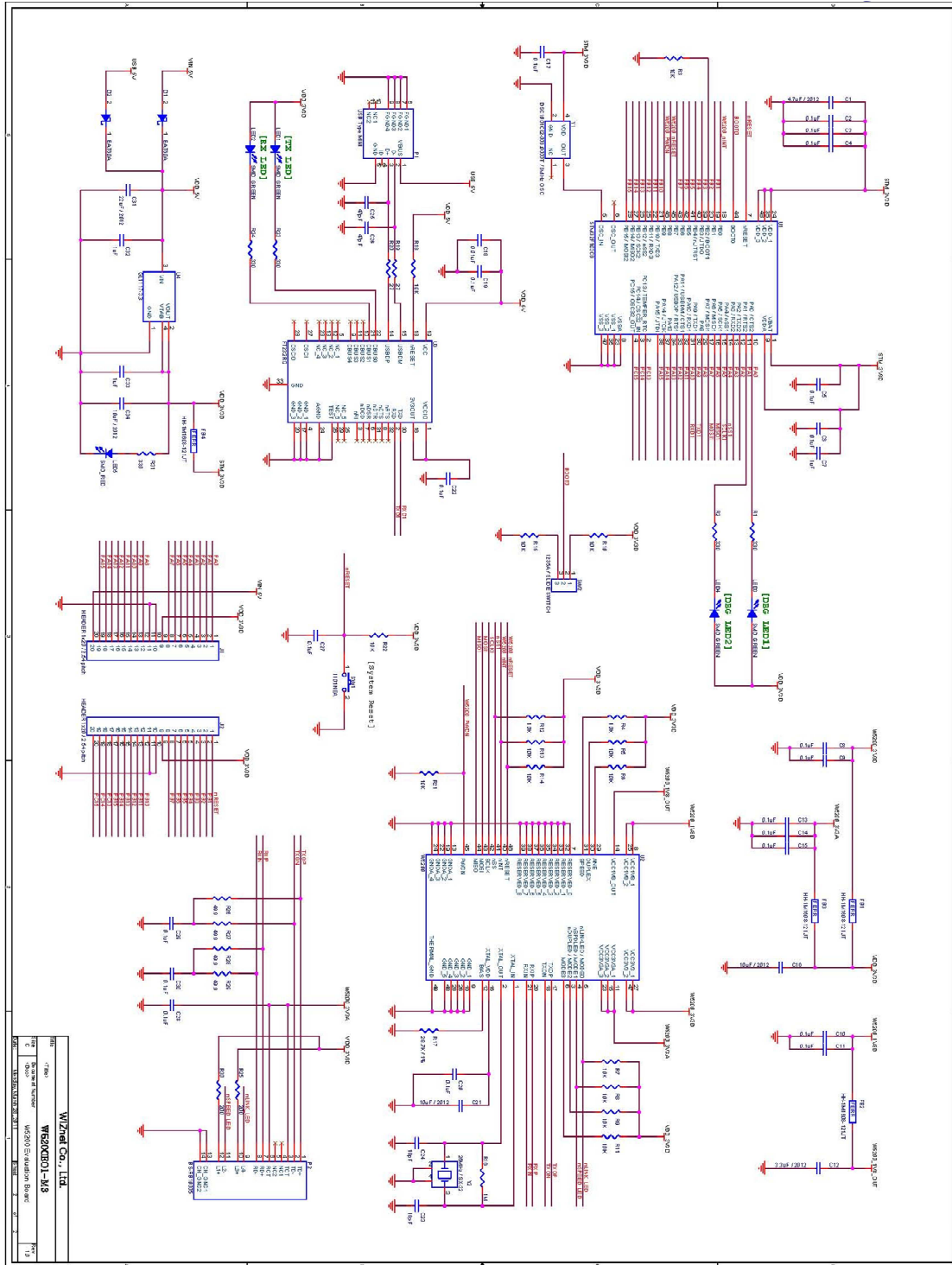

REV	DATE	WIZnet Co., Ltd.
01	2011.07.20	W520-01-M8
02	2011.08.01	W520-01-M8 Rev.2
03	2011.08.01	W520-01-M8 Rev.3
04	2011.08.01	W520-01-M8 Rev.4
05	2011.08.01	W520-01-M8 Rev.5
06	2011.08.01	W520-01-M8 Rev.6
07	2011.08.01	W520-01-M8 Rev.7
08	2011.08.01	W520-01-M8 Rev.8
09	2011.08.01	W520-01-M8 Rev.9
10	2011.08.01	W520-01-M8 Rev.10

Document History Information

Revision	Date	Description
Ver. 1.0.0	MAR 29, 2011	Release
Ver. 1.0.1	FEB 21, 2012	Fixed the URL of FTDI chip website at 6.3 <i>USB-to-UART interface IC (P.8)</i>

Copyright Notice

Copyright © 2011 WIZnet Co.,Ltd. All Rights Reserved.

Technical Support: support@wiznet.co.kr

Sales & Distribution: sales@wiznet.co.kr

For more information, visit our website at <http://www.wiznet.co.kr>