

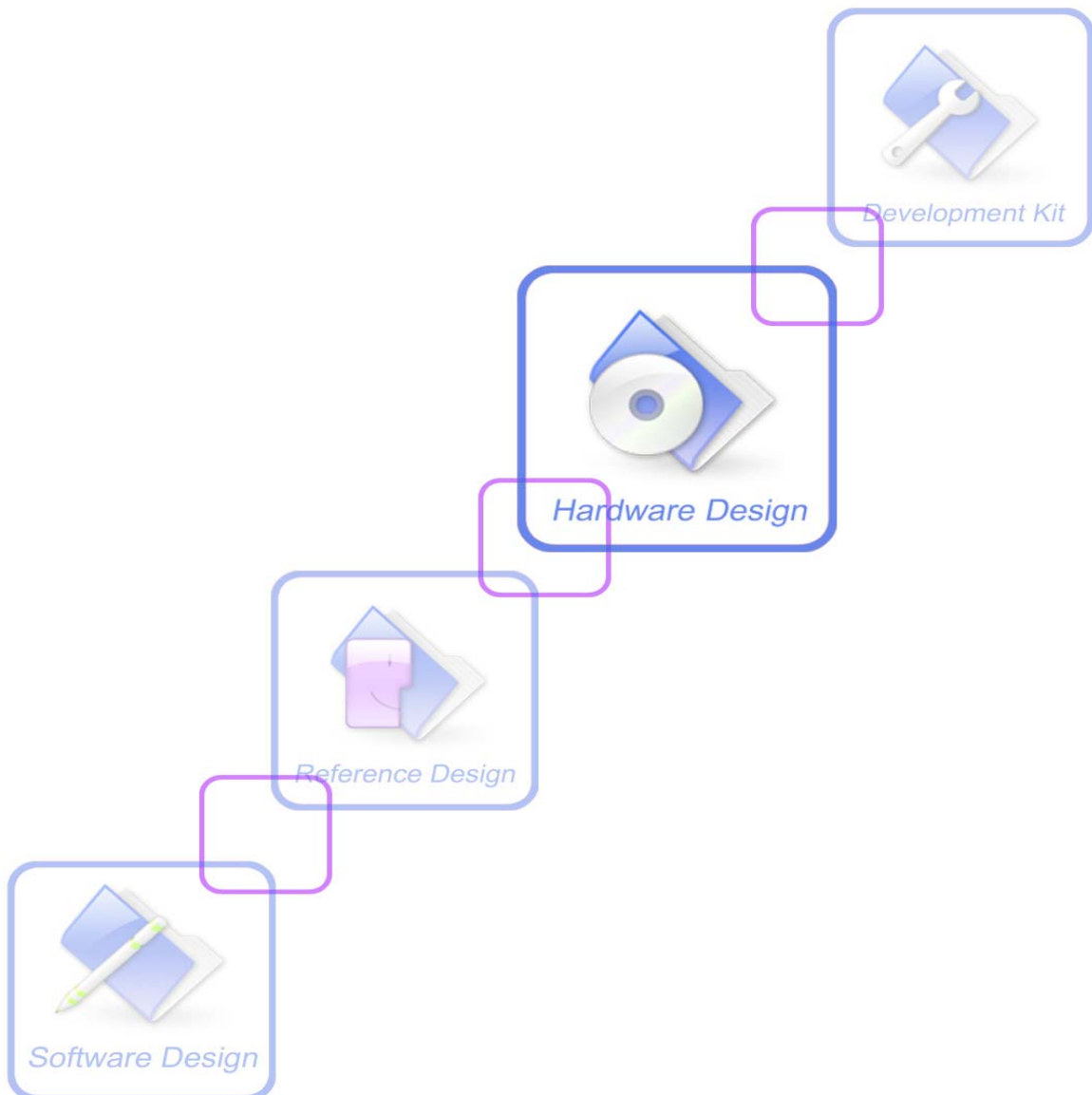

A company of SIM Tech

SIM5360-PCIE_Hardware Design_V1.03



Document Title	SIM5360-PCIE Hardware Design
Version	1.03
Date	2015-01-22
Status	Release
Document Control ID	SIM5360-PCIE_Hardware_Design_V1.03

General Notes

SIMCom offers this information as a service to its customers, to support application and engineering efforts that use the products designed by SIMCom. The information provided is based upon requirements specifically provided to SIMCom by the customers. SIMCom has not undertaken any independent search for additional relevant information, including any information that may be in the customer's possession. Furthermore, system validation of this product designed by SIMCom within a larger electronic system remains the responsibility of the customer or the customer's system integrator. All specifications supplied herein are subject to change.

Copyright

This document contains proprietary technical information which is the property of SIMCom Limited, copying of this document and giving it to others and the using or communication of the contents thereof, are forbidden without express authority. Offenders are liable to the payment of damages. All rights reserved in the event of grant of a patent or the registration of a utility model or design. All specification supplied herein are subject to change without notice at any time.

Copyright © Shanghai SIMCom Wireless Solutions Ltd. 2015

Contents

Version History	6
1. Introduction	7
2. SIM5360-PCIE Overview	8
2.1. SIM5360-PCIE Key Features.....	9
2.2. Operating Mode.....	11
2.3. Functional Diagram.....	11
3. Package Information	13
3.1. Pin Out Diagram.....	13
3.2. PCI Express Mini Card Connector Pin Description.....	14
3.3. Package Dimensions.....	15
4. Application Interface	16
4.1. Power Supply.....	16
4.2. Power Saving Mode.....	16
4.2.1 Minimum Functionality Mode and Sleep Mode.....	16
4.2.2 Wake Up SIM5360-PCIE from Sleep Mode.....	17
4.3. USB 2.0.....	17
4.3.1. USB Port Specification.....	17
4.3.2. Firmware Update.....	17
4.4. SIM Card Interface.....	17
4.5. PCM Interface.....	18
4.6. PERST#.....	19
4.7. W_DISABLE#.....	20
4.8. LED_WWAN#.....	20
4.9. WAKE#.....	21
4.10. SMT Antenna Connector.....	22
5. Electrical, Reliability and Radio Characteristics	23
5.1. Absolute Maximum Ratings.....	23
5.2. Recommended Operating Conditions.....	23
5.3. SIM Card Interface Characteristics.....	23
5.4. USIM_VDD Characteristics.....	24
5.5. Current Consumption (VCC =3.3V+0.3V/-0.1V).....	24
5.6. Electro-Static Discharge.....	25
5.7. Radio Characteristics.....	26
5.7.1. Conducted Output Power.....	26
5.7.2. Conducted Receive Sensitivity.....	26
5.7.3. Supported Band.....	27
6. Appendix	28
I. SIM5360-PCIE Top and Bottom View.....	28
II. Dimensions of SIM5360-PCIE.....	29
III. Related Documents.....	31
IV. Terms and Abbreviations.....	32
V. Safety Caution.....	34

Table Index

TABLE 1: SIM5360-PCIE SERIES FREQUENCY BANDS	8
TABLE 2: SIM5360-PCIE KEY FEATURES	9
TABLE 3: CODING SCHEMES AND MAXIMUM NET DATA RATES OVER AIR INTERFACE	9
TABLE 4: OPERATING MODE.....	11
TABLE 5: PCI EXPRESS MINI CARD CONNECTOR PIN DESCRIPTION	14
TABLE 6: RECOMMENDED 3.3V POWER SUPPLY CHARACTERISTICS	16
TABLE 7: THE CURRENT CONSUMPTION OF MINIMUM FUNCTIONALITY MODE (BS-PA-MFRMS=5).....	16
TABLE 8: USB PORT SPECIFICATION	17
TABLE 9: PCM SPECIFICATION	18
TABLE 10: PCM DC CHARACTERISTICS	19
TABLE 11: PERST# ELECTRICAL CHARACTERISTIC.....	19
TABLE 12: FLIGHT MODE CONTROL FUNCTION	20
TABLE 13: W_DISABLE# ELECTRICAL CHARACTERISTIC	20
TABLE 14: NETWORK STATUS INDICATION PIN STATUS	20
TABLE 15: RECOMMENDED PASSIVE ANTENNA CHARACTERISTICS	22
TABLE 16: RECOMMENDED ACTIVE ANTENNA CHARACTERISTICS	22
TABLE 17: ABSOLUTE MAXIMUM RATINGS.....	23
TABLE 18: OPERATING CONDITIONS	23
TABLE 19: SIM CARD INTERFACE CHARACTERISTICS.....	23
TABLE 20: USIM_VDD CHARACTERISTICS	24
TABLE 21: CURRENT CONSUMPTION	24
TABLE 22: ESD CHARACTERISTICS (TEMPERATURE: 25°C, HUMIDITY: 45%).....	26
TABLE 23: CONDUCTED OUTPUT POWER.....	26
TABLE 24: CONDUCTED RECEIVE SENSITIVITY	26
TABLE 25: SUPPORTED BAND.....	27
TABLE 26: RELATED DOCUMENTS	31
TABLE 27: TERMS AND ABBREVIATIONS.....	32
TABLE 28: SAFETY CAUTION.....	34

Figure Index

FIGURE 1: SIM5360-PCIE FUNCTIONAL DIAGRAM.....	12
FIGURE 2: SIM5360-PCIE PIN OUT DIAGRAM	13
FIGURE 3: DIMENSIONS OF SIM5360-PCIE(UNIT: MM))	15
FIGURE 4: SIM CARD HOLDER REFERENCE CIRCUIT	18
FIGURE 5: RESET TIMING	19
FIGURE 6: LED_WWAN# REFERENCE CIRCUIT.....	20
FIGURE 7: WAKE# BEHAVIOUR	21
FIGURE 8: WAKE# BEHAVIOR AS A CALLER.....	21
FIGURE 9: WAKE# REFERENCE CIRCUIT.....	21
FIGURE 10: SIM5360-PCIE TOP AND BOTTOM VIEW.....	28
FIGURE 11: DIMENSIONS OF SIM5360-PCIE (UNIT: MM TOP VIEW).....	29
FIGURE 12: DIMENSIONS OF SIM5360-PCIE (UNIT: MM BOTTOM AND SIDE VIEW).....	30

SIMCOM CONFIDENTIAL FILE

Version History

Date	Version	Description of change	Author
2014-04-01	1.01	Origin	Libing
2014-07-10	1.02	Modify pin names of SIM5360-PCIE Modify figure1 and figure4.	Libing
2015-01-22	1.03	Modify weight of SIM5360-PCIE Modify table 18.	Libing

SIMCOM CONFIDENTIAL FILE

1. Introduction

SIM5360-PCIE module is PCI Express Mini Card. This document describes SIM5360-PCIE hardware interface in great detail, which can help user to quickly understand SIM5360-PCIE interface specifications, electrical and mechanical details.

SIMCOM CONFIDENTIAL FILE

2. SIM5360-PCIE Overview

SIM5360-PCIE series support quad-band GSM/GPRS/EDGE and dual-band UMTS/HSDPA/HSUPA/HSPA+, which work on frequencies GSM850,EGSM900,DCS1800,PCS1900,WCDMA2100/900 or WCDMA1900/WCDMA850 or WCDMA2100/ WCDMA850

The modules can be chosen based on the wireless network configuration. In this document, the entire radio band configuration of SIM5360-PCIE series is described in the following table.

Table 1: SIM5360-PCIE Series Frequency Bands

Standard	Frequency	SIM5360E-PCIE	SIM5360A-PCIE	SIM5360J-PCIE
GSM	GSM 850MHz	✓	✓	✓
	EGSM 900MHz	✓	✓	✓
	DCS1800MHz	✓	✓	✓
	PCS1900MHz	✓	✓	✓
WCDMA	WCDMA 850MHz		✓	✓
	WCDMA 900MHz	✓		
	WCDMA 1900MHz		✓	
	WCDMA 2100MHz	✓		✓
HSPA	HSDPA	✓	✓	✓
	HSUPA	✓	✓	✓
DRX	Receiver Diversity	✓	✓	✓

SIM5360-PCIE provides various hardware interfaces via Mini PCI Express card connector.

- **Power supply: : 3.3V+0.3/-0.1V**
- **USB Interface**
- **SIM Interface**
- **PCM Interface**
- **W_DISABLE#**
- **WAKE#**
- **PERST#**
- **LED_WWAN#**

2.1. SIM5360-PCIE Key Features

Table 2: SIM5360-PCIE Key Features

Feature	Implementation
Power supply	Single supply voltage 3.3V+0.3V/-0.1V
Transmission data	<ul style="list-style-type: none"> ● Dual-mode UMTS/HSPA+/EDGE/GPRS operation ● GPRS Class B, multislot class 12 operation, Supports coding scheme: CS1-4 ● EDGE multislot class 12 operation, Supports coding schemes MSC1-9 ● UMTS R99 data rates-384 kbps DL/UL ● Category 6 HSDPA -14.4 Mbps HSUPA-5.76 Mbps ● CSD feature: 9.6, 14.4, 64 kbps UL/DL
SMS	<ul style="list-style-type: none"> ● MT, MO, CB, Text and PDU mode ● SMS storage: SIM card or ME(default) ● Support transmission of SMS alternatively over CSD or GPRS. User can choose preferred mode.
SIM interface	Support identity card: 1.8V, 3V.
USB	Support USB2.0 Slave mode
Rx-diversity	Support UMTS Rx-diversity.
Phonebook management	Support phonebook types: SM, FD, LD, RC, ON, MC.
SIM application toolkit	Support SAT class 3, GSM 11.14 Release 98 Support USAT
Physical characteristics	Size: 50.95*32*4.95mm Weight:10.2 g
Firmware upgrade	Firmware upgrade over USB interface
PCM	Multiplex on GPIOs. Used for analog audio function with external codec. Support long frame sync and short frame sync. Support 8-bit A-law, μ -law and 16-bit linear data formats. Support master and slave mode, but must be the master in long frame sync.
Temperature range	<ul style="list-style-type: none"> ● Normal operation temperature: -30°C to +80°C ● Extended operation temperature: -40°C to +85°C ● Storage temperature -45°C to +90°C

Table 3: Coding schemes and maximum net data rates over air interface

Multislot definition(GRPS/EDGE)			
Slot class	DL slot number	UL slot number	Active slot number
1	1	1	2
2	2	1	3
3	2	2	3
4	3	1	4
5	2	2	4

6	3	2	4
7	3	3	4
8	4	1	5
9	3	2	5
10	4	2	5
11	4	3	5
12	4	4	5
GPRS coding scheme	Max data rate (4 slots)	Modulation type	
CS 1 = 9.05 kb/s / time slot	36.2 kb/s	GMSK	
CS 2 = 13.4 kb/s / time slot	53.6 kb/s	GMSK	
CS 3 = 15.6 kb/s / time slot	62.4 kb/s	GMSK	
CS 4 = 21.4 kb/s / time slot	85.6 kb/s	GMSK	
EDGE coding scheme	Max data rate (4 slots)	Modulation type	
MCS 1 = 8.8 kb/s/ time slot	35.2 kb/s	GMSK	
MCS 2 = 11.2 kb/s/ time slot	44.8 kb/s	GMSK	
MCS 3 = 14.8 kb/s/ time slot	59.2 kb/s	GMSK	
MCS 4 = 17.6 kb/s/ time slot	70.4 kb/s	GMSK	
MCS 5 = 22.4 kb/s/ time slot	89.6 kb/s	8PSK	
MCS 6 = 29.6 kb/s/ time slot	118.4 kb/s	8PSK	
MCS 7 = 44.8 kb/s/ time slot	179.2 kb/s	8PSK	
MCS 8 = 54.4 kb/s/ time slot	217.6 kb/s	8PSK	
MCS 9 = 59.2 kb/s/ time slot	236.8 kb/s	8PSK	
HSDPA device category	Max data rate (peak)	Modulation type	
Category 1	1.2Mbps	16QAM,QPSK	
Category 2	1.2Mbps	16QAM,QPSK	
Category 3	1.8Mbps	16QAM,QPSK	
Category 4	1.8Mbps	16QAM,QPSK	
Category 5	3.6Mbps	16QAM,QPSK	
Category 6	3.6Mbps	16QAM,QPSK	
Category 7	7.2Mbps	16QAM,QPSK	
Category 8	7.2Mbps	16QAM,QPSK	
Category 9	10.2Mbps	16QAM,QPSK	
Category 10	14.4Mbps	16QAM,QPSK	
HSUPA device category	Max data rate (peak)	Modulation type	
Category 1	0.96Mbps	QPSK	
Category 2	1.92Mbps	QPSK	
Category 3	1.92Mbps	QPSK	
Category 4	3.84Mbps	QPSK	
Category 5	3.84Mbps	QPSK	
Category 6	5.76Mbps	QPSK	

2.2. Operating Mode

The table below summarizes the various operating modes of SIM5360-PCIE.

Table 4: Operating Mode

Mode	Function	
Normal operation	GSM/GPRS/EDGE/WCDMA/HSPA+ SLEEP	Module will automatically go into sleep mode if the conditions of sleep mode are enabling and there is no on air and no hardware interrupt (such as GPIO interrupt or data on serial port). In this case, the current consumption of module will reduce to the minimal level. In sleep mode, the module can still receive paging message and SMS.
	GSM/WCDMA IDLE	Software is active. Module registered to the GSM/WCDMA network, and the module is ready to communicate.
	GSM/WCDMA TALK	Connection between two subscribers is in progress. In this case, the power consumption depends on network settings such as DTX off/on, FR/EFR/HR, hopping sequences, antenna.
	GPRS/EDGE/HSPA+ STANDBY	Module is ready for GPRS/EDGE/HSPA+ data transfer, but no data is currently sent or received. In this case, power consumption depends on network settings and GPRS/EDGE/HSPA+ configuration.
	GPRS/EDGE/HSPA+ DATA TRANSFER	There is GPRS/EDGE/HSPA+ data transfer in progress. In this case, power consumption is related with network settings (e.g. power control level); uplink/downlink data rates and GPRS configuration (e.g. used multi-slot settings).
Minimum functionality mode	AT command “AT+CFUN” can be used to set the module to a minimum functionality mode without removing the power supply. In this mode, the RF part of the module will not work or the SIM card will not be accessible, or both RF part and SIM card will be closed, and the serial port is still accessible. The power consumption in this mode is lower than normal mode.	

2.3. Functional Diagram

The following figure is SIM5360-PCIE functional diagram.

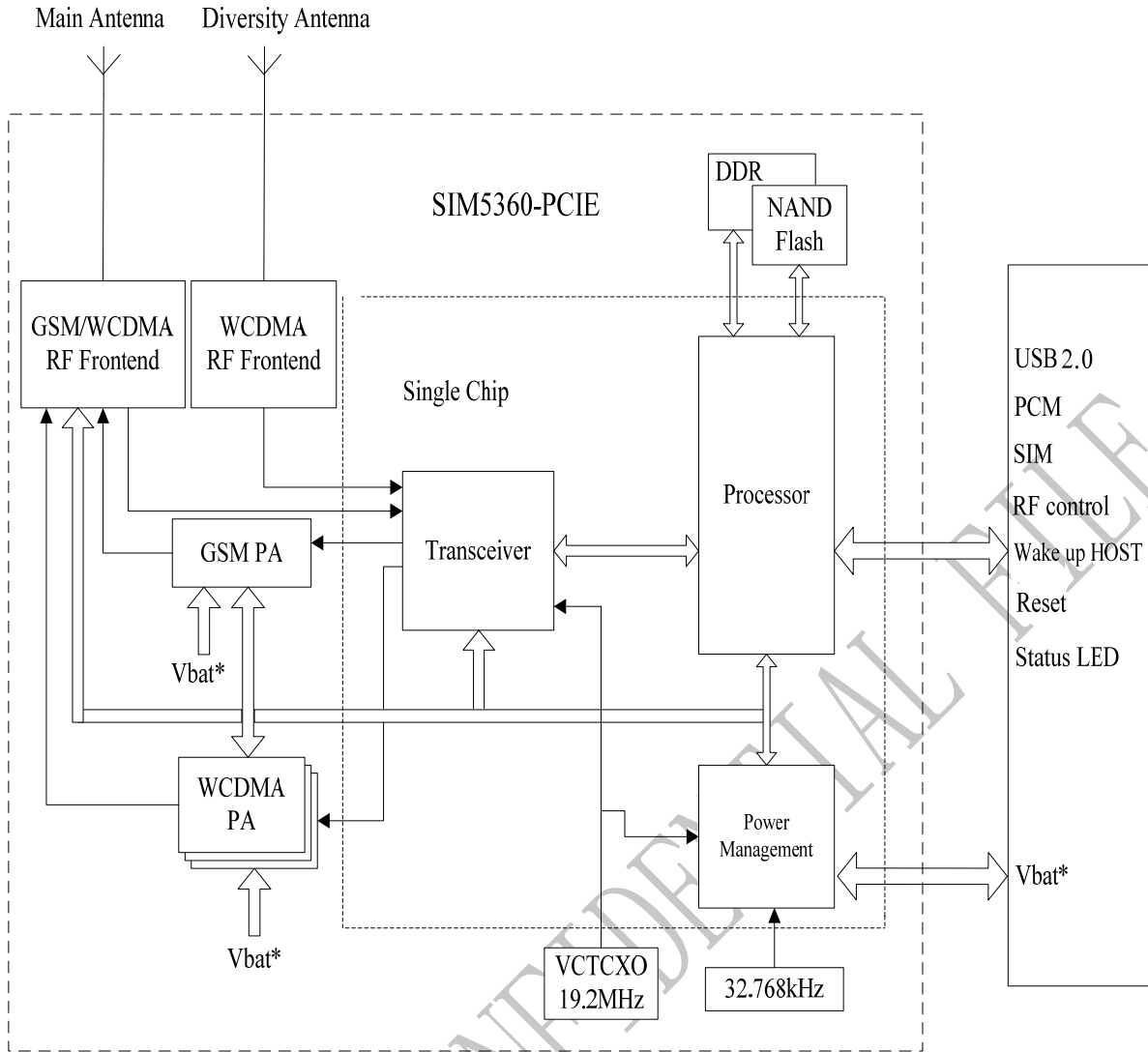

Figure 1: SIM5360-PCIE Functional Diagram

3. Package Information

3.1. Pin Out Diagram

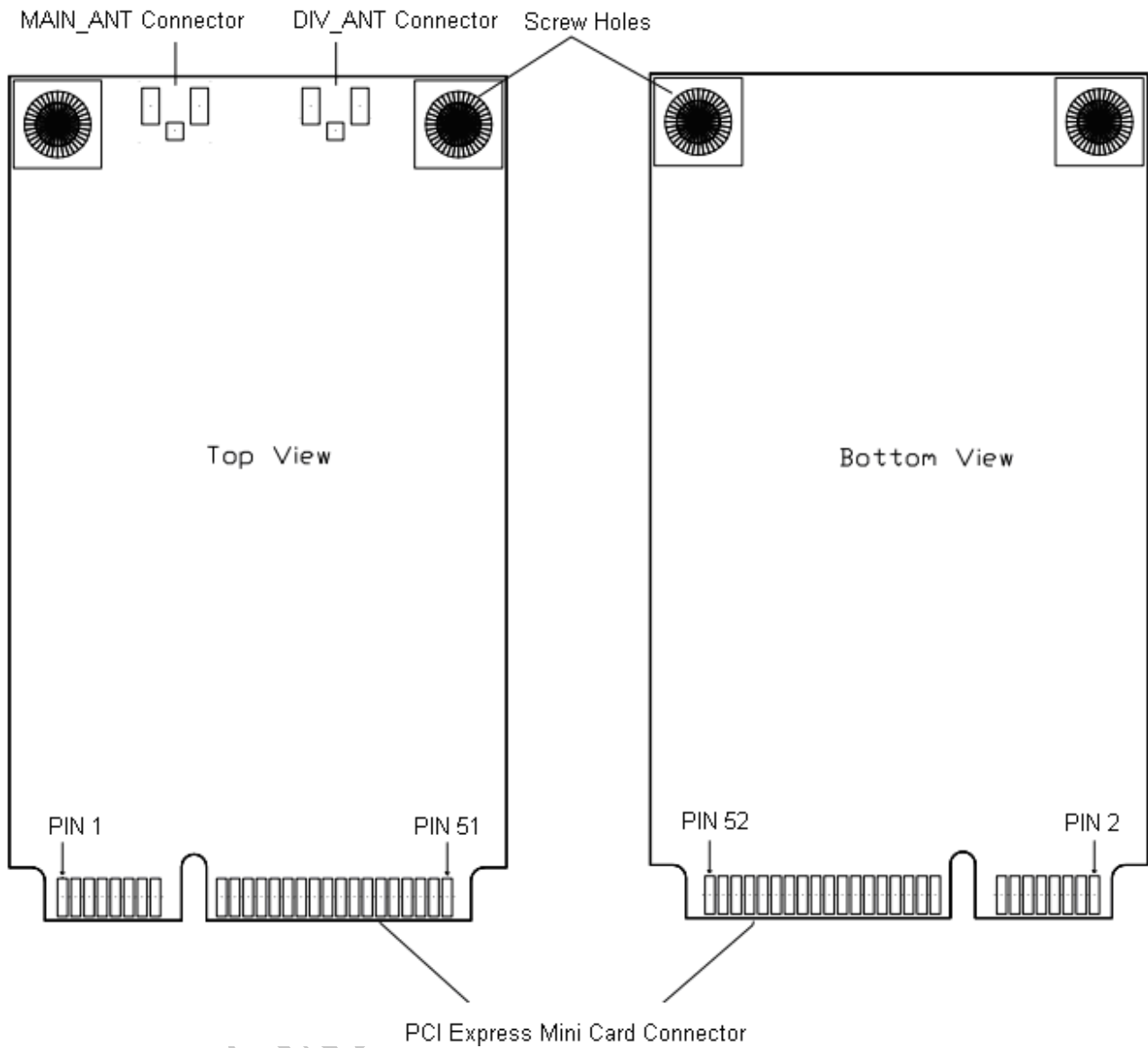

Figure 2: SIM5360-PCIE Pin Out Diagram

3.2. PCI Express Mini Card Connector Pin Description

Table 5: PCI Express Mini Card Connector Pin Description

Pin name	Pin number	I/O	Description	Comment
Power supply				
VCC	2,39,41,52	I	3.3 Power supply for module	
GND	4,9,15,18,21, 26,27,29,34,3 5,37,40,43,50		Ground	
Reset				
PERST#	22	I	Reset input (Active low)	
USB 2.0				
USB_DP	38	I/O	USB 2.0 high speed port for data transfer, voice call, debug and FW download, etc.	
USB_DN	36			
SIM card interface				
USIM_VDD	8	O	1.8/3.0V Configurable LDO output, default 1.8V output, maximum output current is 30mA	
USIM_DATA	10	I/O	SIM data input/output	
USIM_CLK	12	O	SIM clock	
USIM_RST	14	O	SIM reset	
PCM interface				
PCM_CLK	45	O	PCM clock	If these pins are unused, keep open
PCM_OUT	47	O	PCM data output	
PCM_IN	49	I	PCM data input	
PCM_SYNC	51	O	PCM synchrony	
others				
WAKE#	1	O	Wake up host	
W_DISABLE#	20	I	RF Control Input	
LED_WWAN#	42	O	Network Status Indication output	
NC	3,5,6,7,11,13, 16,17,19,23,2 4,25,28,30,31 ,32,33,44,46, 48	--	No connection	Keep open

**: If Analog audio is needed, please consult our sales staff, for more information .*

3.3. Package Dimensions

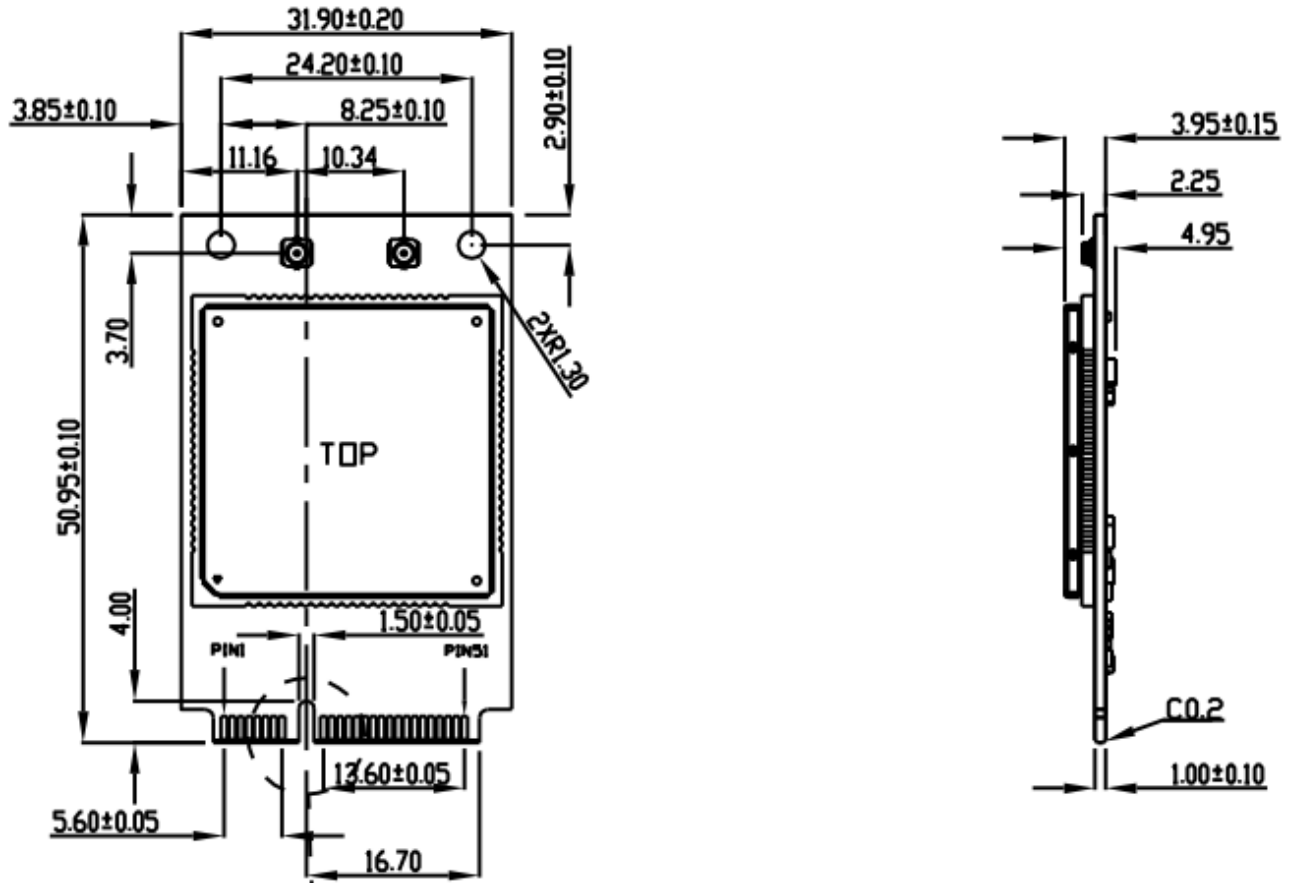

Figure 3: Dimensions of SIM5360-PCIE(Unit: mm)

Please refer to appendix for package dimension details.

SIMCOM CONFIDENTIAL

4. Application Interface

4.1. Power Supply

The recommended power supply voltage of SIM5360-PCIE is 3.3V.

Table 6: Recommended 3.3V Power Supply Characteristics

Symbol	Parameter	Min	Type	Max	Unit
V _O	Power supply voltage	3.2	3.3	3.6	V
I _O	Supply current capability	2000	-	-	mA

4.2. Power Saving Mode

SIM5360-PCIE has two power saving modes: minimum functionality mode and sleep mode. When SIM5360-PCIE is in sleep mode and minimum functionality mode, the current of module is lowest.

4.2.1 Minimum Functionality Mode and Sleep Mode

The AT command “AT+CFUN=<fun>” can be used to set SIM5360-PCIE into minimum functionality.

There are three functionality modes, which could be set by the AT command “AT+CFUN=<fun>”. The command provides the choice of the functionality levels <fun>=0, 1, 4.

- AT+CFUN=0: Minimum functionality.
- AT+CFUN=1: Full functionality (default).
- AT+CFUN=4: Flight mode (disable RF function).

Table 7: The Current Consumption of Minimum Functionality Mode (BS-PA-MFRMS=5)

<fun>	Current consumption(mA) (sleep mode)
0	1.4
1	2.7
4	1.4

Minimum functionality mode minimizes the current consumption to the lowest level. If SIM5360-PCIE is set to minimum functionality by “AT+CFUN=0”, the RF function and SIM card function will be disabled. In this case, the serial port and USB port are still accessible, but all AT commands correlative with RF function and SIM card function will not be accessible.

Note: For detailed information about the AT Command “AT+CFUN=<fun>”, please refer to *document [1]*.

If USB HOST sends USB suspend request, SIM5360-PCIE will enter sleep mode automatically for reducing power consume, when peripheral equipment of SIM5360-PCIE stops working, and module has no on air or audio activity required. In sleep mode, SIM5360-PCIE can still receive paging or SMS from network.

Note: SIM5360-PCIE could enter sleep mode when the host CPU supports USB suspend mode, otherwise it could not enter sleep mode.

4.2.2 Wake Up SIM5360-PCIE from Sleep Mode

When SIM5360-PCIE is in sleep mode, the following methods can wake up the module:

- USB HOST sends USB resume request.
- Receive a voice or data call from network.
- Receive a SMS from network.

4.3. USB 2.0

SIM5360-PCIE is compliant with USB 2.0 specification. It supports full-speed and high-speed when acting as a peripheral device.

4.3.1. USB Port Specification

SIM5360-PCIE could achieve data transfer, voice call, debug and software download, etc, through USB interface. When module is powered on, and connected USB_DP, USB_DN and GND to PC, and driver installed successfully, then 5 COM port, “SIMTECH HS-USB Modem 9000”, “SIMTECH HS-USB NMEA 9000”, “SIMTECH HS-USB AT port 9000”, “SIMTECH HS-USB Diagnostics 9000” and “SIMTECH Wireless HS-USB Ethernet Adapter 9000” could be recognized by the USB HOST.

Table 8: USB port Specification

Port Name	Description
SIMTECH HS-USB AT port 9000	Module could be controlled by sending AT command via USB Application Port.
SIMTECH HS-USB Diagnostics 9000	Module could be debugged by grabbing log through USB Debug Port.
SIMTECH HS-USB NMEA 9000	GPS data could be achieved through SIMTECH NMEA Device port. SIM5360-PCIE has not this function.
SIMTECH HS-USB Modem 9000	Module could transfer data through Modem.

4.3.2. Firmware Update

If users need to upgrade through USB port, it is necessary to power on SIM5360-PCIE first, then connect USB_DP, USB_DN, GND to USB HOST.

4.4. SIM Card Interface

The SIM interface complies with the GSM Phase 1 specification and the new GSM Phase 2+ specification for FAST 64 kbps SIM card. Both 1.8V and 3.0V SIM card are supported. The SIM interface is powered from an internal regulator in the module.

It is recommended to use an ESD protection component such as ST (www.st.com) ESDA6V1W5. Note that the SIM peripheral circuit should be close to the SIM card socket. The reference circuit of the 6-pin SIM card holder is illustrated in the following figure.

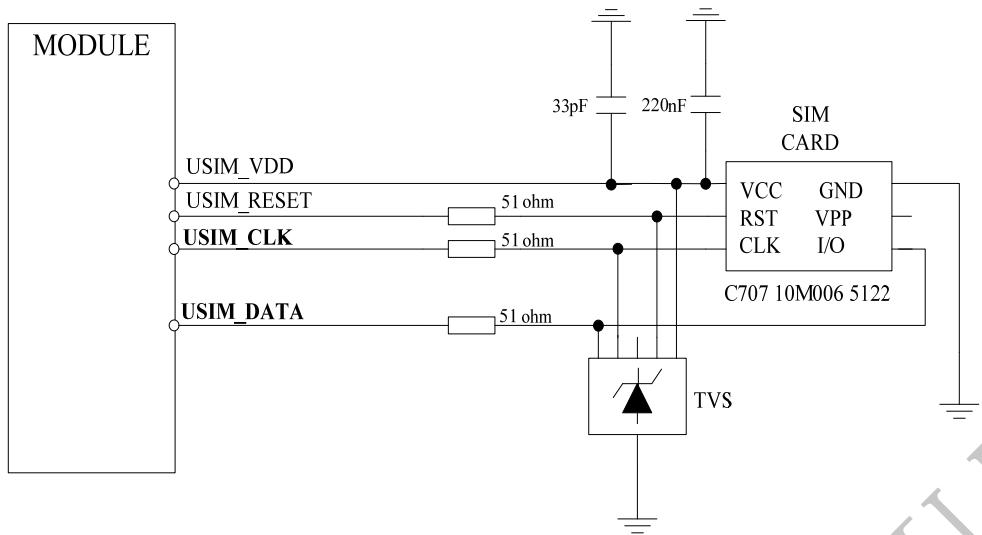

Figure 4: SIM Card Holder Reference Circuit

SIM card circuit is susceptible to be interfered, causing the SIM card failure or some other issues, so it is strongly recommended to follow these guidelines while designing:

- Make sure that SIM card holder should stay away from GSM antenna while in PCB layout;
- SIM traces should keep away from RF lines, VBAT and high-speed signal lines, and the shorter the better;
- Keep good connectivity between SIM holder GND and module GND;
- It is recommended to do some protection on USIM_CLK to keep away from interference;
- Recommended to place a 1uF capacitor on USIM_VDD line and keep close to the holder;
- Place some TVS, the parasitic capacitance should not exceed 50pF, and cascade 51Ohm resistor to enhance ESD protection.

4.5. PCM Interface

SIM5360-PCIE provides hardware PCM interface for external codec. The PCM interface enables communication with an external codec to support hands-free applications. SIM5360-PCIE PCM interface can be used in two modes: the default mode is auxiliary PCM (8 KHz short sync mode at 2048 KHz PCM CLK); the other mode is primary PCM (8 KHz long sync mode at 128 KHz PCM CLK). In short-sync (primary PCM) mode, SIM5360-PCIE can be a master or a slave. In long-sync (auxiliary PCM) mode, SIM5360-PCIE is always a master. SIM5360-PCIE also supports 3 kinds of coding formats: 8 bits (u-law or A-law) and 16 bits (linear).

Table 9: PCM Specification

Characteristics	Specification
Line Interface Format	Linear or 8 bits (u-law or A-law)
Data length	16bits or 8 bits
PCM Clock/Sync Source	Master or a slave Mode(2048 KHz) / Master Mode(128 KHz)
PCM Clock Rate	2048 KHz / 128Khz
PCM Sync Format	Short sync/Long sync both support

Note: PCM interface can be control by AT command. For more details please refer to document [1] and document [2]

Table 10: PCM DC Characteristics

Symbol	Parameter	Min	Type	Max	Unit
V _{IH}	High-level input voltage	1.26	1.8	2.1	V
V _{IL}	Low-level input voltage	-0.3	0	0.63	V
V _{OH}	High-level output voltage	1.35	1.8	1.8	V
V _{OL}	Low-level output voltage	0	0	0.45	V

4.6. PERST#

The PERST# pin could be used as an emergency reset. SIM5360-PCIE has power-up reset function, so power-up reset pulse is not necessary. When the PERST# pin is pulled to ground, the module will be reset. The PERST# pin is already pulled up in module, so the external pull-up resistor is not necessary.

The following table is the electrical characteristics of The PERST# pin.

Table 11: PERST# Electrical Characteristic

Symbol	Parameter	Min	Type	Max	Unit
V _{IH}	High-level input voltage	1.7	1.8	3.6	V
V _{IL}	Low-level input voltage	-	-	0.3	V
T _{high-hold}	After power up AND-NOT operation time(keep high level or keep open)	250	-	-	ms
T _{low-hold}	Reset low level hold on time	300	-	-	us

The low level pulse time must is longer than 300us, The following figure is the timing of reset function.

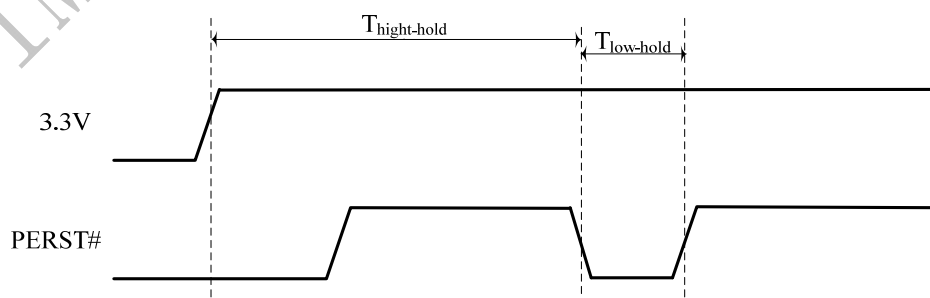

Figure 5: Reset Timing

4.7. W_DISABLE#

The W_DISABLE# pin controls SIM5360-PCIE to enter or exit the Flight mode by default. In Flight mode, RF function is closed to prevent interference with other equipments or minimize current consumption.

Table 12: Flight mode control Function

W_DISABLE# status	Module operation
Low Level	Flight Mode: RF is closed.
High Level	Normal Mode: RF is working.

Table 13: W_DISABLE# Electrical Characteristic

Symbol	Parameter	Min	Type	Max	Unit
V _{IH}	High-level input voltage	3.0	3.3	3.6	V
V _{IL}	Low-level input voltage	-	-	0.3	V
T low-hold	low level hold on time	300	-	-	us

4.8. LED_WWAN#

The LED_WWAN# pin can be used to drive a network status indication LED by default. Its status is listed by following table.

Table 14: Network Status Indication Pin Status

LED_WWAN# Status	Working Status
On	Searching Network/Call Connect
200ms On, 200ms Off	Data Transmit
800ms On, 800ms Off	Registered network
Off	Power off / Sleep

Reference circuit is recommended in the following figure:

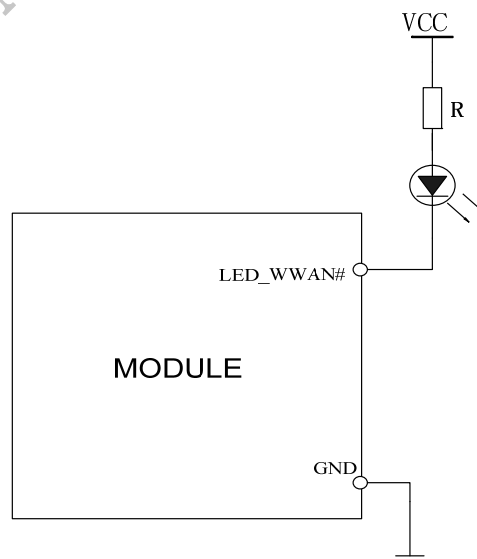

Figure 6: LED_WWAN# Reference Circuit

4.9. WAKE#

The WAKE# pin can be used as an interrupt signal to host. Normally it will keep high logic level until certain condition such as receiving SMS, voice call (CSD, video) or URC reporting, then WAKE# will change to low logic level to inform the master (client PC). It will stay low until the master clears the interrupt event with AT command.

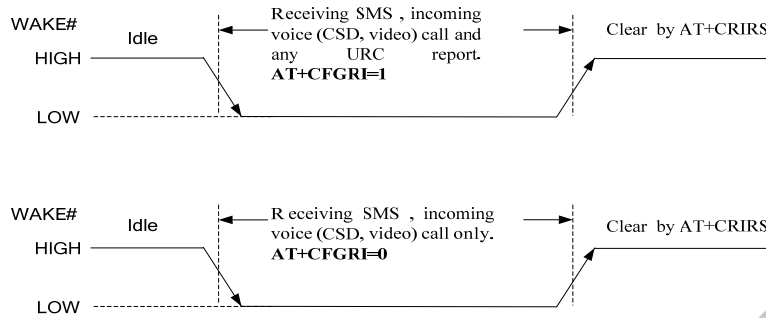

Figure 7: WAKE# behaviour

However, if the module is used as caller, the WAKE# will remain high. Please refer to the following figure.

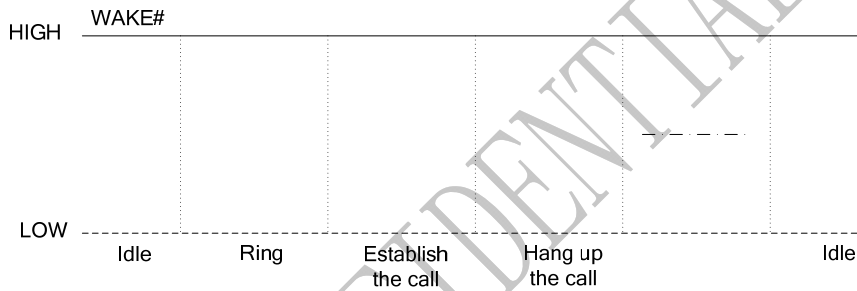

Figure 8: WAKE# behavior as a caller

WAKE# Reference circuit is recommended in the following figure:

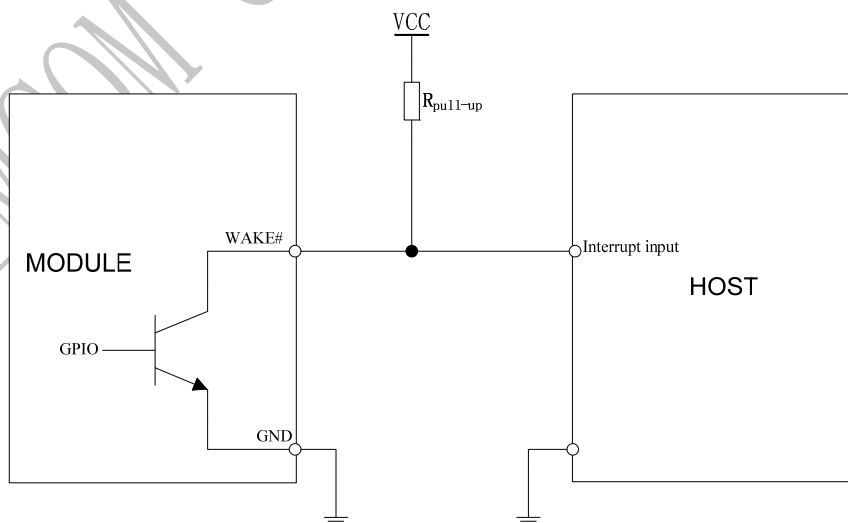

Figure 9: WAKE# Reference Circuit

4.10.SMT Antenna Connector

SIM5360-PCIE have two antenna connectors, one is the main GSM/WCDMA antenna connector, the other is WCDMA diversity antenna connector. Recommended antenna characteristics of SIM5360-PCIE are described by following tables.

Table 15: Recommended Passive Antenna Characteristics

Passive	Recommended standard
Direction	omnidirectional
Gain	> -3dBi (Avg)
Input impedance	50 ohm
Efficiency	> 50 %
VSWR	< 2

Table 16: Recommended Active Antenna Characteristics

Band	Performance	
	TRP	TIS
GSM850	≅ 29dBm	≅ -104dBm
EGSM900	≅ 29dBm	≅ -104dBm
DCS1800	≅ 26dBm	≅ -104dBm
PCS1900	≅ 26dBm	≅ -104dBm
WCDMA B1	≅ 19dBm	≅ -104dBm
WCDMA B2	≅ 19dBm	≅ -104dBm
WCDMA B5	≅ 19dBm	≅ -104dBm
WCDMA B8	≅ 19dBm	≅ -104dBm

5. Electrical, Reliability and Radio Characteristics

5.1. Absolute Maximum Ratings

The absolute maximum ratings are described by the following table. Module may be damaged beyond these ratings.

Table 17: Absolute maximum ratings

Symbol	Parameter	Min	Type	Max	Unit
V _{VCC}	VCC input voltage	0	-	3.6	V
I _{VCC}	VCC total peak current	0	-	2.0	A
I _I *	Input current	-	-	4	mA
I _O *	Output current	-	-	4	mA

*Note: * These parameters are for digital interface pins, such as PCM.*

5.2. Recommended Operating Conditions

Please refer to the follow table for recommended operating conditions.

Table 18: Operating Conditions

Symbol	Parameter	Min	Type	Max	Unit
V _{VCC}	3.3V Input voltage	3.2	3.3	3.6	V
T _{OPER}	Normal operating temperature	-30	+25	+80	°C
	Extended operating temperature	-40	+25	+85	
T _{STG}	Storage temperature	-45	+25	+90	°C

Note: The module is fully functional in all the temperature range. Temperatures outside of the range -30°C ~ +80°C might slightly deviate from ETSI specifications.

Functional: the module is able to make and receive voice calls, data calls, SMS and make GPRS/WCDMA/HSPA+ traffic.

5.3. SIM Card Interface Characteristics

Table 19: SIM Card Interface Characteristics

Symbol	Parameter	Min	Type	Max	Unit	
UIM_RST	V _{OH}	USIM_VDD=1.8V	1.62	-	-	V
		USIM_VDD=3.0V	2.7	-	-	V

	V _{OL}	USIM_VDD=1.8V	-	-	0.36	V
		USIM_VDD=3.0V	-	-	0.36	V
USIM_CLK	V _{OH}	USIM_VDD=1.8V	1.62	-	-	V
		USIM_VDD=3.0V	2.7	-	-	V
	V _{OL}	USIM_VDD=1.8V	-	-	0.216	V
		USIM_VDD=3.0V	-	-	0.4	V
USIM_DATA	V _{IH}	USIM_VDD=1.8V	1.4	-	-	V
		USIM_VDD=3.0V	2.6	-	-	V
	V _{IL}	USIM_VDD=1.8V	-	-	0.27	V
		USIM_VDD=3.0V	-	-	0.4	V
	V _{OH}	USIM_VDD=1.8V	1.4	-	-	V
		USIM_VDD=3.0V	2.6	-	-	V
	V _{OL}	USIM_VDD=1.8V	-	-	0.27	V
		USIM_VDD=3.0V	-	-	0.4	V

5.4. USIM_VDD Characteristics

Table 20: USIM_VDD Characteristics

Symbol	Parameter	Min	Type	Max	Unit
V _O	Output voltage	2.85	3.0	3.15	V
		1.7	1.80	1.9	
I _O	Output current	-	-	30	mA

5.5. Current Consumption (VCC =3.3V+0.3V/-0.1V)

Table 21: Current Consumption

GSM Sleep Mode (with USB suspended)	
GSM/GPRS supply current	Sleep @DRX=2 4.5mA
	Sleep @DRX=5 2.7mA
	Sleep @DRX=9 2.3mA
Voice Call	
GSM850	@power level #5 <300mA, Typical 263mA
GSM 900	@power level #5 <300mA, Typical 261mA
DCS1800	@power level #0 <250mA, Typical 218mA
PCS1900	@power level #0 <260mA, Typical 257mA
GPRS Data	
DATA mode, GPRS (1 Rx,4 Tx) CLASS 12	
GSM 850	@power level #5 <660mA, Typical 525mA
GSM 900	@power level #5 <660mA, Typical 480mA
DCS1800	@power level #0 <530mA, Typical 420mA
PCS1900	@power level #0 <530mA, Typical 420mA

DATA mode, GPRS (3Rx, 2 Tx) CLASS 12	
GSM 850	@power level #5 <460mA, Typical 360mA
GSM 900	@power level #5 <440mA, Typical 325mA
DCS1800	@power level #0 <400mA, Typical 285mA
PCS1900	@power level #0 <300mA, Typical 295mA
EDGE Data	
DATA mode, EDGE(1 Rx,4 Tx) CLASS 12	
GSM 850	@power level #8 <500mA, Typical 370mA
GSM 900	@power level #8 <500mA, Typical 365mA
DCS1800	@power level #2 <450mA, Typical 350mA
PCS1900	@power level #2 <450mA, Typical 350mA
DATA mode, EDGE(3Rx, 2 Tx) CLASS 12	
GSM 850	@power level #8 <330mA, Typical 250mA
GSM 900	@power level #8 <330mA, Typical 250mA
DCS1800	@power level #2 <300mA, Typical 225mA
PCS1900	@power level #2 <300mA, Typical 225mA
UMTS Sleep/Idle Mode (with USB suspended)	
WCDMA supply current	Sleep mode @DRX=9 1.8 mA
	Sleep mode @DRX=8 2.3 mA
	Sleep mode @DRX=6 3.6 mA
	Idle mode @DRX=6 32 mA
UMTS Talk	
WCDMA 2100	@Power 23dBm Typical 460 mA
	@Power 21dBm Typical 410 mA
	@Power 10dBm Typical 245 mA
WCDMA 1900	@Power 23dBm Typical 460 mA
	@Power 21dBm Typical 440 mA
	@Power 10dBm Typical 280 mA
WCDMA 850	@Power 23dBm Typical 440 mA
	@Power 21dBm Typical 400 mA
	@Power 10dBm Typical 250 mA
WCDMA 900	@Power 23dBm Typical 400 mA
	@Power 21dBm Typical 355 mA
	@Power 10dBm Typical 230 mA
HSDPA Data	
WCDMA 2100	@Power 23dBm CQI=22 Typical 520 mA
WCDMA 1900	@Power 23dBm CQI=22 Typical 510 mA
WCDMA 850	@Power 23dBm CQI=22 Typical 460 mA
WCDMA 900	@Power 23dBm CQI=22 Typical 450 mA

Note: In above table the current consumption value is the typical one of the module tested in laboratory. In the mass production stage, there may be differences among each individual.

5.6. Electro-Static Discharge

SIM5360-PCIE is an ESD sensitive component, so more attention should be paid to the procedure of handling and packaging. The ESD test results are shown in the following table.

Table 22: ESD characteristics (Temperature: 25°C, Humidity: 45 %)

Pin	Contact discharge	Air discharge
VCC	±5KV	±10KV
GND	±5KV	±10KV
Antenna port	±5KV	±10KV
USB_DP,USB_DN	±4KV	±8KV

5.7. Radio Characteristics

5.7.1. Conducted Output Power

The following table shows SIM5360-PCIE's conducted output power, comply with 3GPP TS 05.05 and TS 34.121.

Table 23: Conducted Output Power

Frequency	Max	Min
GSM850	33dBm ±2dB	5dBm ± 5dB
E-GSM900	33dBm ±2dB	5dBm ± 5dB
DCS1800	30dBm ±2dB	0dBm ± 5dB
PCS1900	30dBm ±2dB	0dBm ± 5dB
GSM850 (8-PSK)	27dBm ±3dB	5dBm ± 5dB
E-GSM900 (8-PSK)	27dBm ±3dB	5dBm ± 5dB
DCS1800 (8-PSK)	26dBm +3/-4dB	0dBm ±5dB
PCS1900(8-PSK)	26dBm +3/-4dB	0dBm ±5dB
WCDMA 2100	24dBm +1/-3dB	-56dBm ±5dB
WCDMA 1900	24dBm +1/-3dB	-56dBm ±5dB
WCDMA 850	24dBm +1/-3dB	-56dBm ±5dB
WCDMA 900	24dBm + 1/-3dB	-56dBm ±5dB

5.7.2. Conducted Receive Sensitivity

The following table shows conducted receiving sensitivity of SIM5360-PCIE.

Table 24: Conducted Receive Sensitivity

Frequency	Receive sensitivity
GSM850	< -109dBm
E-GSM900	< -109dBm
DCS1800	< -109dBm
DCS1800	< -109dBm
WCDMA 2100	< -110dBm
WCDMA 1900	< -110dBm
WCDMA 850	< -110dBm
WCDMA 900	< -110dBm

Remark: The data in above table get at static condition.

5.7.3. Supported Band

The following table shows SIM5360-PCIE supported band, and complies with 3GPP spec.

Table 25: Supported Band

Frequency	Receiving	Transmission
GSM850	869 ~894 MHz	824 ~849 MHz
E-GSM900	925 ~960 MHz	880 ~915 MHz
DCS1800	1805~1880 MHz	1710~1785 MHz
PCS1900	1930~1990 MHz	1850~1910 MHz
WCDMA 2100	2110~2170 MHz	1920~1980 MHz
WCDMA1900	1930~1990 MHz	1850~1910 MHz
WCDMA 850	869 ~894 MHz	824 ~849 MHz
WCDMA 900	925 ~960 MHz	880 ~915 MHz

SIMCOM CONFIDENTIAL FILE

6. Appendix

I. SIM5360-PCIE Top and Bottom View



Figure 10: SIM5360-PCIE Top and Bottom View

II. Dimensions of SIM5360-PCIE

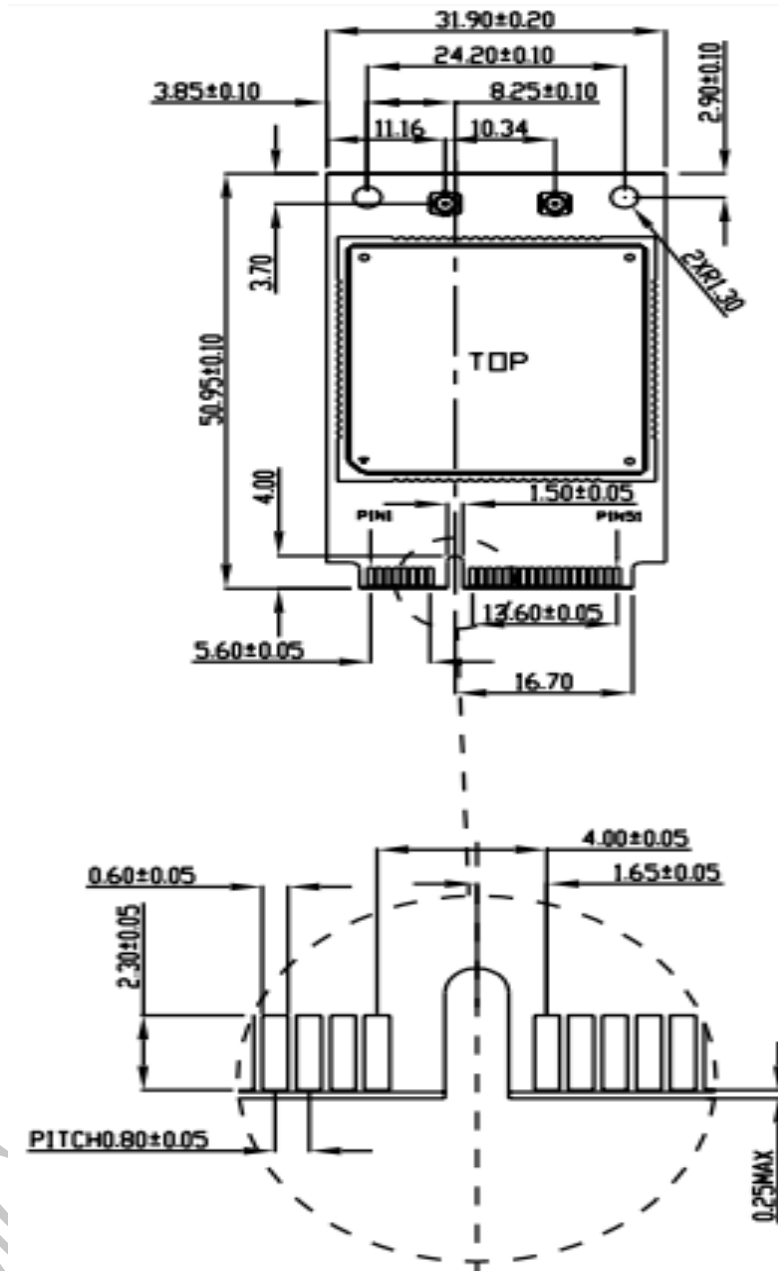

Figure 11: Dimensions of SIM5360-PCIE (Unit: mm Top view)

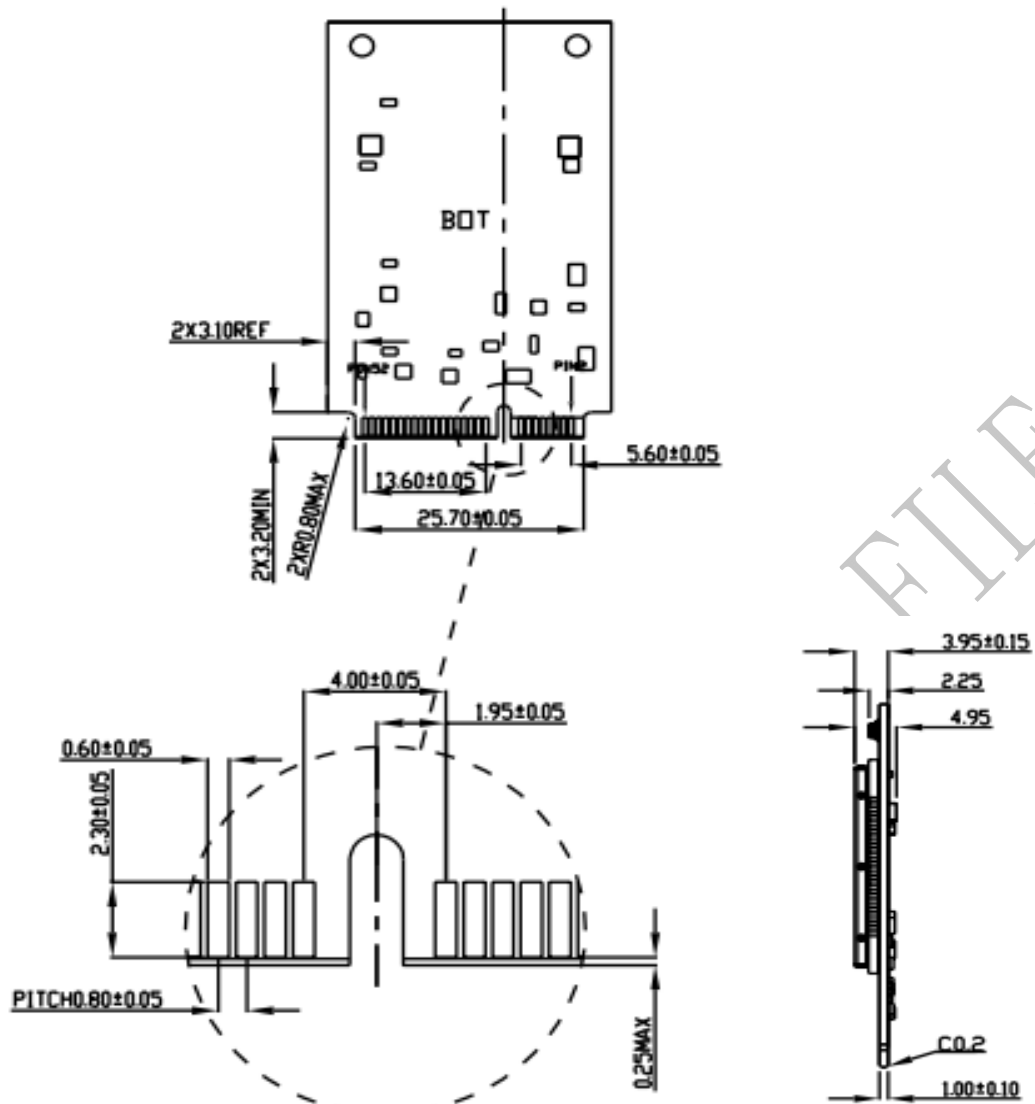

Figure 12: Dimensions of SIM5360-PCIE (Unit: mm Bottom and Side view)

III. Related Documents

Table 26: Related Documents

SN	Document name	Remark
[1]	SIMCOM_SIM5360_ATC_EN_V1.XX.doc	
[2]	SIM5360_Audio_Application_Note	SIM5360_Audio_Application_Note
[3]	ITU-T Draft new recommendation V.25ter:	Serial asynchronous automatic dialing and control
[4]	GSM 07.07:	Digital cellular telecommunications (Phase 2+); AT command set for GSM Mobile Equipment (ME)
[5]	GSM 07.10:	Support GSM 07.10 multiplexing protocol
[6]	GSM 07.05:	Digital cellular telecommunications (Phase 2+); Use of Data Terminal Equipment – Data Circuit terminating Equipment (DTE – DCE) interface for Short Message Service (SMS) and Cell Broadcast Service (CBS)
[7]	GSM 11.14:	Digital cellular telecommunications system (Phase 2+); Specification of the SIM Application Toolkit for the Subscriber Identity Module – Mobile Equipment (SIM – ME) interface
[8]	GSM 11.11:	Digital cellular telecommunications system (Phase 2+); Specification of the Subscriber Identity Module – Mobile Equipment (SIM – ME) interface
[9]	GSM 03.38:	Digital cellular telecommunications system (Phase 2+); Alphabets and language-specific information
[10]	GSM 11.10	Digital cellular telecommunications system (Phase 2); Mobile Station (MS) conformance specification; Part 1: Conformance specification

SIMCOM

IV. Terms and Abbreviations

Table 27: Terms and Abbreviations







Abbreviation	Description
ADC	Analog-to-Digital Converter
AMR	Adaptive Multi-Rate
CS	Coding Scheme
CSD	Circuit Switched Data
CTS	Clear to Send
DTE	Data Terminal Equipment (typically computer, terminal, printer)
DTR	Data Terminal Ready
DTX	Discontinuous Transmission
EFR	Enhanced Full Rate
EGSM	Enhanced GSM
ESD	Electrostatic Discharge
ETS	European Telecommunication Standard
FR	Full Rate
GPRS	General Packet Radio Service
GSM	Global Standard for Mobile Communications
HR	Half Rate
IMEI	International Mobile Equipment Identity
Li-ion	Lithium-Ion
MO	Mobile Originated
MS	Mobile Station (GSM engine), also referred to as TE
MT	Mobile Terminated
PAP	Password Authentication Protocol
PBCCH	Packet Broadcast Control Channel
PCB	Printed Circuit Board
PCL	Power Control Level
PCS	Personal Communication System, also referred to as GSM 1900
PDU	Protocol Data Unit
PPP	Point-to-point protocol
RF	Radio Frequency
RMS	Root Mean Square (value)
RTC	Real Time Clock
WCDMA	Wideband Code Division Multiple Access
HSDPA	High Speed Downlink Packet Access
HSUPA	High Speed Uplink Packet Access
RX	Receive Direction
SIM	Subscriber Identification Module
SMS	Short Message Service

TE	Terminal Equipment, also referred to as DTE
TX	Transmit Direction
UART	Universal Asynchronous Receiver & Transmitter
URC	Unsolicited Result Code
USSD	Unstructured Supplementary Service Data
Phonebook abbreviations	
FD	SIM fix dialing phonebook
LD	SIM last dialing phonebook (list of numbers most recently dialed)
MC	Mobile Equipment list of unanswered MT calls (missed calls)
ON	SIM (or ME) own numbers (MSISDNs) list
RC	Mobile Equipment list of received calls
SM	SIM phonebook
NC	Not connect

SIMCOM CONFIDENTIAL

V. Safety Caution

Table 28: Safety caution

Marks	Requirements
	When in a hospital or other health care facility, observe the restrictions about the use of mobiles. Switch the cellular terminal or mobile off, medical equipment may be sensitive to not operate normally for RF energy interference.
	Switch off the cellular terminal or mobile before boarding an aircraft. Make sure it is switched off. The operation of wireless appliances in an aircraft is forbidden to prevent interference with communication systems. Forget to think much of these instructions may lead to the flight safety or offend against local legal action, or both.
	Do not operate the cellular terminal or mobile in the presence of flammable gases or fumes. Switch off the cellular terminal when you are near petrol stations, fuel depots, chemical plants or where blasting operations are in progress. Operation of any electrical equipment in potentially explosive atmospheres can constitute a safety hazard.
	Your cellular terminal or mobile receives and transmits radio frequency energy while switched on. RF interference can occur if it is used close to TV sets, radios, computers or other electric equipment.
	Road safety comes first! Do not use a hand-held cellular terminal or mobile when driving a vehicle, unless it is securely mounted in a holder for hands free operation. Before making a call with a hand-held terminal or mobile, park the vehicle.
	<p>GSM cellular terminals or mobiles operate over radio frequency signals and cellular networks and cannot be guaranteed to connect in all conditions, for example no mobile fee or a invalid SIM card. While you are in this condition and need emergent help, please remember using emergency calls. In order to make or receive calls, the cellular terminal or mobile must be switched on and in a service area with adequate cellular signal strength.</p> <p>Some networks do not allow for emergency call if certain network services or phone features are in use (e.g. lock functions, fixed dialing etc.). You may have to deactivate those features before you can make an emergency call.</p> <p>Also, some networks require that a valid SIM card be properly inserted in the cellular terminal or mobile.</p>

Contact us:

Shanghai SIMCom Wireless Solutions Ltd.

Add: SIM Technology Building, No.633,Jinzhong Road, Changning District, Shanghai P.R. China 200335

Tel: +86 21 3235 3300

Fax: +86 21 3235 3301

URL: www.sim.com/wm

SIMCOM CONFIDENTIAL FILE