

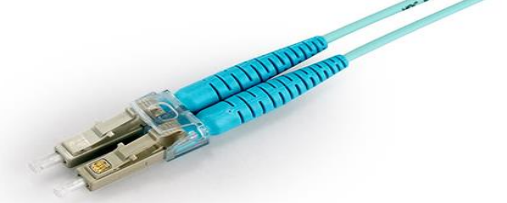

# TE Connectivity IP68 Micro USB2.0 Connector Overview



# IP68 Micro USB2.0 Connector Introduction



Micro USB2.0 interface

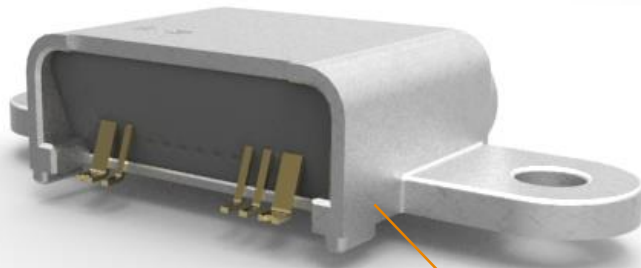

R/A receptacle



Screw mounting ears

TE Connectivity (TE) micro USB connectors are well-known for their reliability, robustness and versatility in meeting different USB applications. To satisfy its customers' emerging needs, TE has designed the IP68 micro USB2.0 connector, an upgrade to the IP57 connector, to provide stronger protection for today's smaller and thinner mobile devices against the ingress of water and solid objects such as dust.

The ingress protection (IP) rating specifies the degree of protection against either solid objects or liquid. The first digit describes the protection against solid objects, while the second digit indicates the protection against liquid. The higher the number, the better the protection. The IP68 connector remains intact at a water depth of 1.5m for a minimum of 30 minutes, which is one of the highest standards of available relevant products in the market.

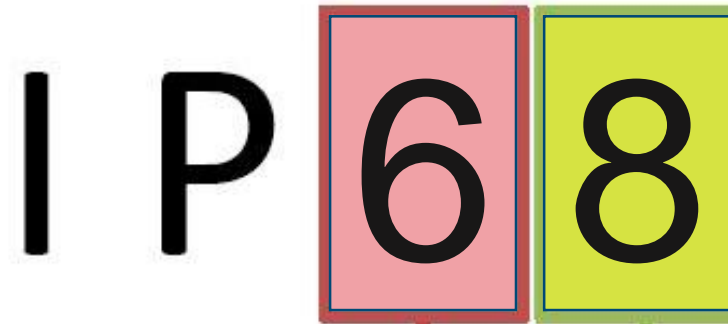

1 <sup>st</sup> Digit	Definition
0	No Protection against contact and ingress of objects
1	Protected against any large surface of the body, such as the back of a hand. Protected against solid objects greater than 50mm in size.
2	Protected against access to hazardous parts by a finger or similar object. Protected against solid objects greater than 12.5mm in size.
3	Protected against access to hazardous parts with a tool or thick wire. Protected against solid objects greater than 2.5mm in size.
4	Protected against access to hazardous parts with a wire, screw, etc. Protected against solid objects greater than 1mm in size.
5	Protected against access to hazardous parts. Dust protected.
6	Protected against access to hazardous parts. Dust-tight.

2 <sup>nd</sup> Digit	Definition
0	No Protection
1	Protected against water drops
2	Protected against water drops at a 15 degree angle
3	Protected against water spray at 60 degree angle
4	Protected against water splashing from any angle
5	Protected against water jets from any angle
6	Protected against powerful water jets and heavy seas
7	Protected against the effects of temporary submersion in water. Test requires 30 minutes at 1 meter depth.
8	Protected against the effects of temporary submersion. Customer specification applies and specific testing may be required.
9K	Protects against high pressures associated with steam cleaning.

# Key Features

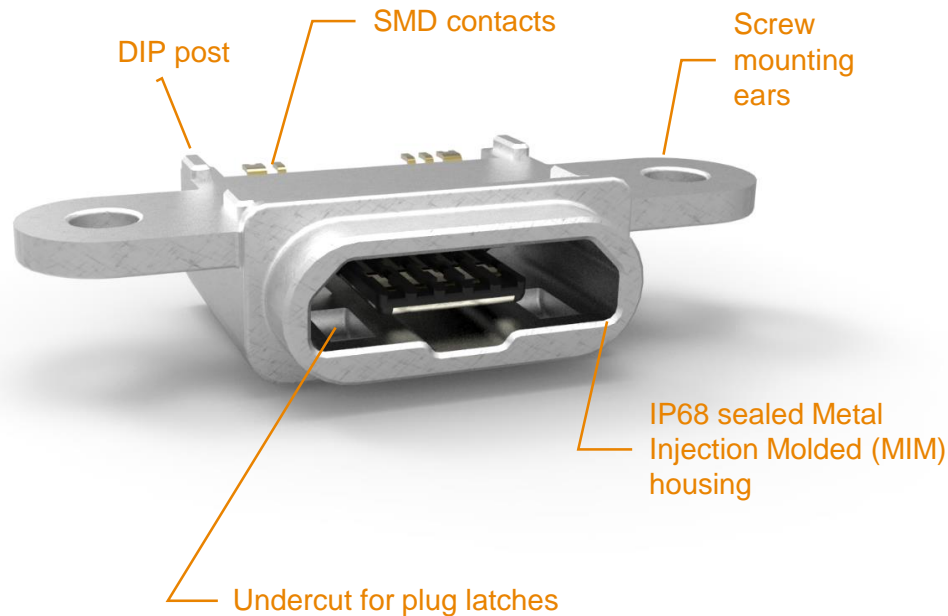

- Dimension H 3.04mm x W 17.8mm (with ears) x D 7.9mm
- Staggered contact provides improved signal separation as well as enhanced mechanical stability.
- The MIM shell provides the lowest height possible with the metal shield and waterproof structure integrated in one piece; it provides a strong structure — a 3D-molded structure.
- Equipped with an undercut matching the plug latches, the connector keeps the plug mated like the normal micro USB connector.
- The metal reinforcement plate prevents damage to the plastic tab containing the contacts inside the connector and helps prevent potential electrical short circuits.
- The circular interface to the main shell allows for easy integration of the connector in a device.
- Screw mounting ears make it easier to integrate and position the connector in the final application.

# Key Applications

- Cell phones/smartphones
- Tablets
- MP3 players
- GPS units
- e-Readers
- Home electronic devices
- Digital cameras and camcorders
- Wearable devices



# Design Application

- In order to integrate this component in the device, a silicone-compliant seal is required to close off the perimeter of the connector against water ingress.
- This seal must be supplied by the OEM. The seal should accommodate some level of tolerance stack-up but it is typically limited.
- There are two ways to reduce the tolerance stack-up:
  1. Screw the connector and PCB board to the device casing in close proximity to the connector, using the mounting ears on the MIM shell.
  2. Mount the connector on an FPC and encapsulate it in the device frame. The fixing does not need a screw.

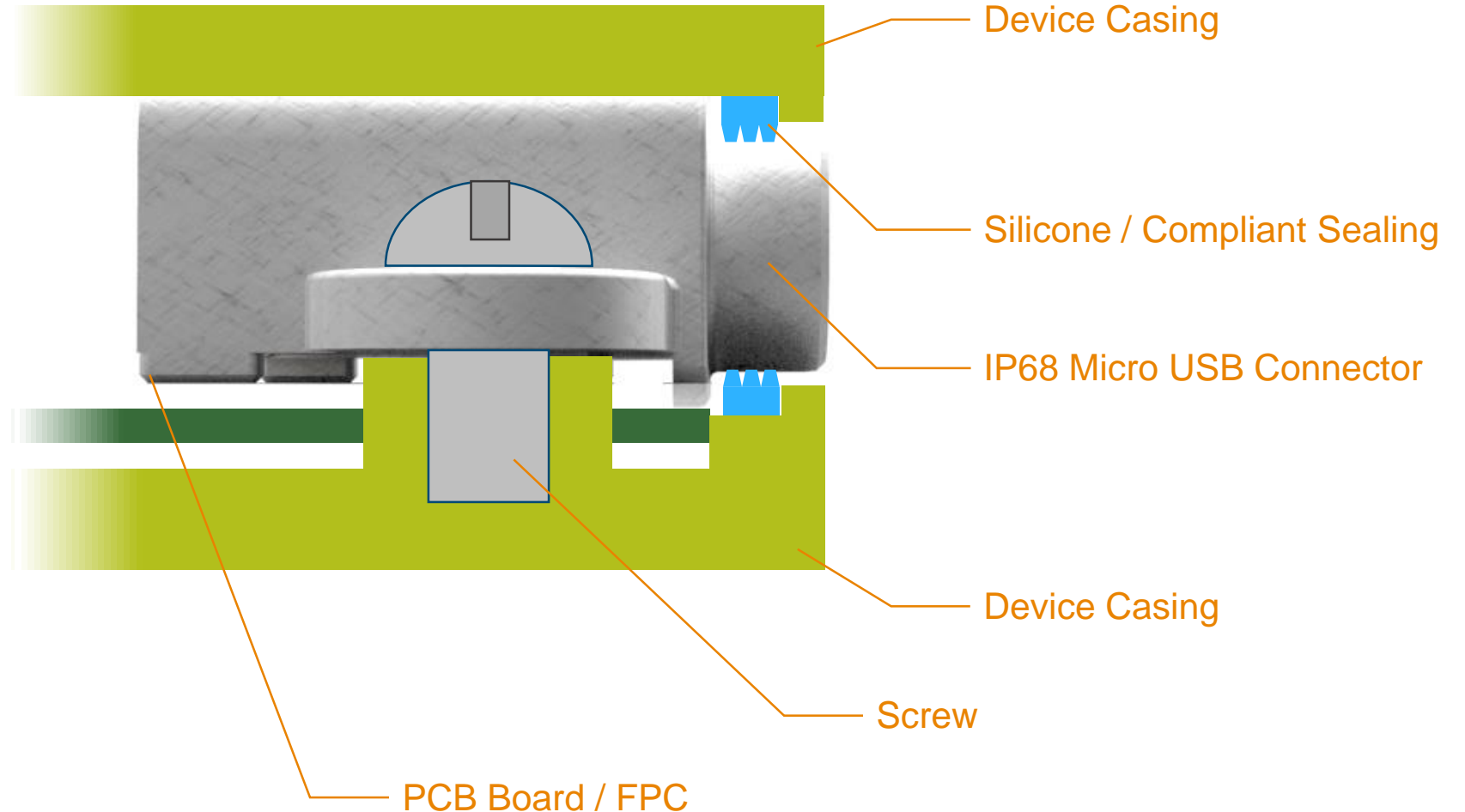

# Pin Assignment

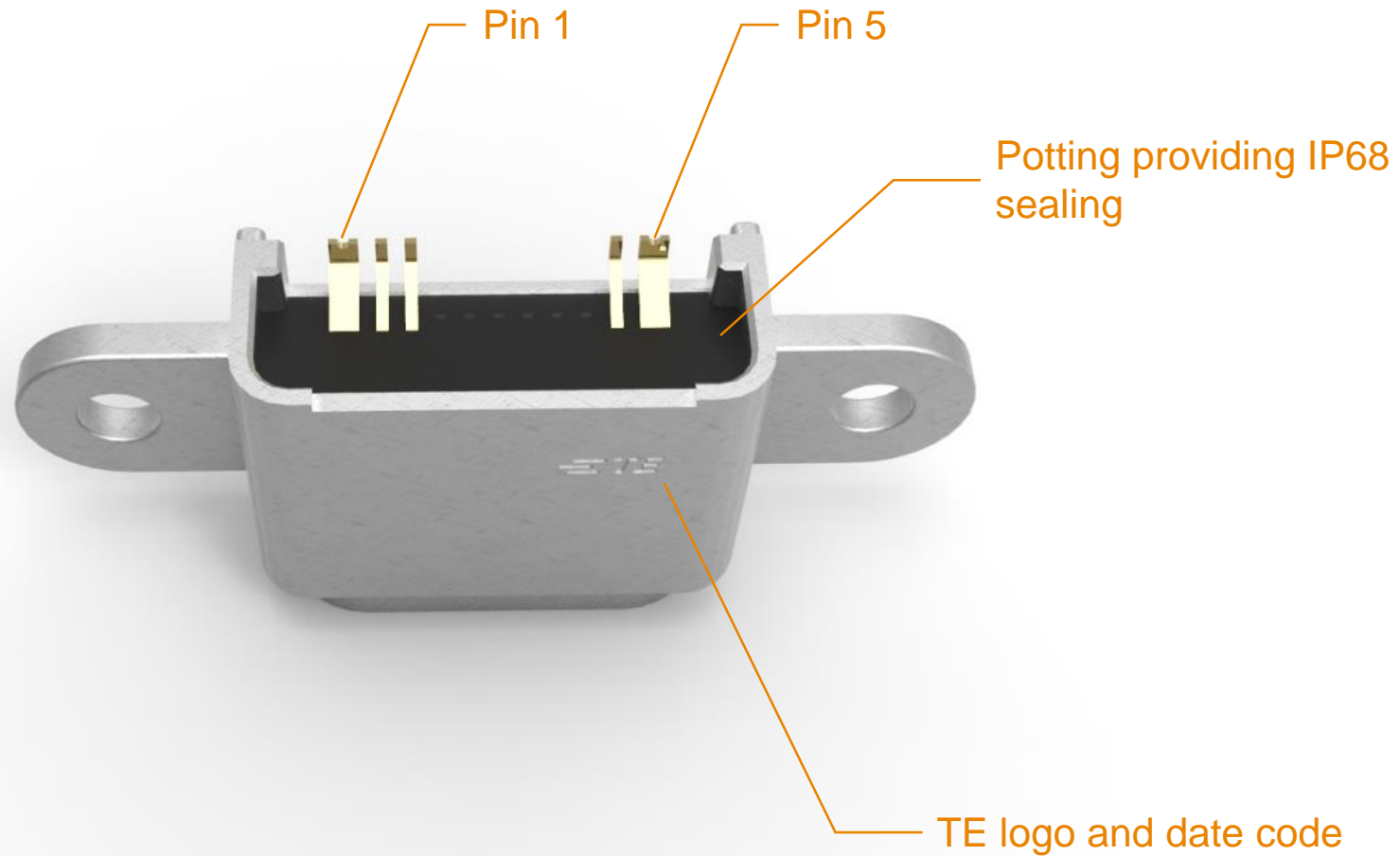

Pin assignment	
1	Vbus
2	D-
3	D+
4	ID
5	GND

# Dimension

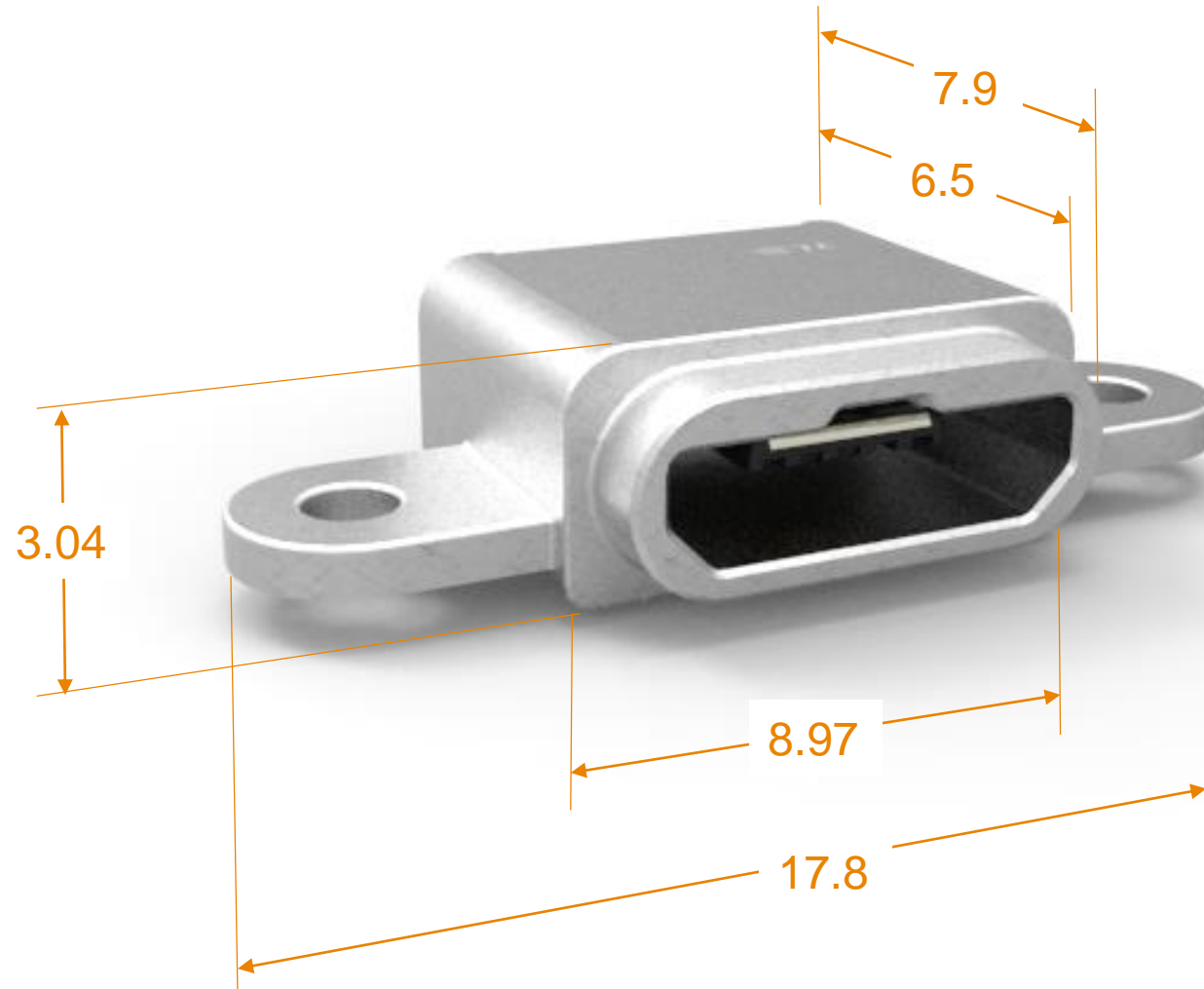



# Why a MIM shell? Reduced Component Height

## Over-molded Shell Design

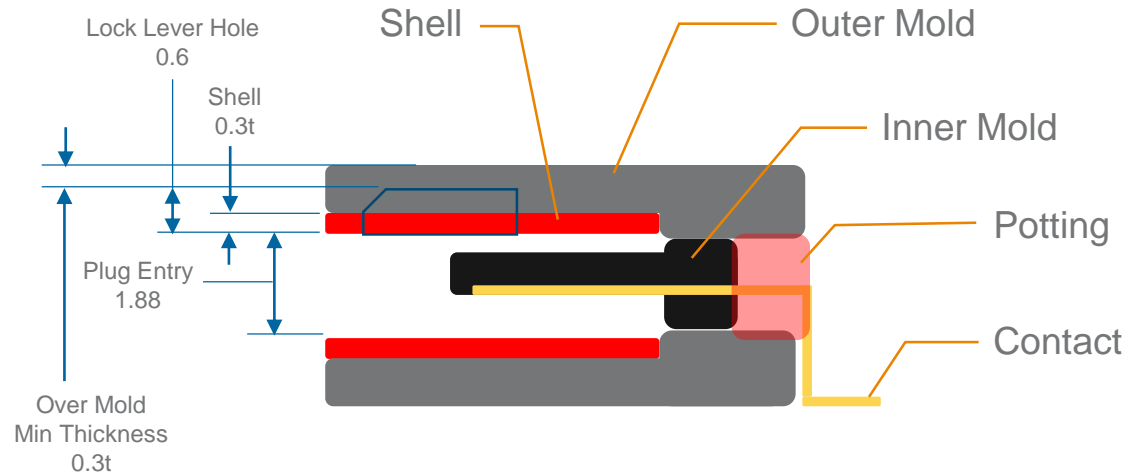

Shell over mold must present a tight interface for potting  
 Shell thickness + Outer Mold thickness → Increased Thickness and therefore Overall Height

$$\begin{aligned}
 & \text{Height} = 1.88 \text{ (Plug)} \\
 & 0.6 \text{ (Shell Top \& Lock Lever Hole Bottom)} \\
 & 0.3 \text{ (Shell Bottom)} \\
 & 0.6 \text{ (Over Mold)} \\
 & \hline
 & + \\
 & = 3.38 \text{ (Min. requirement Height)}
 \end{aligned}$$

## TE's MIM Shell Design

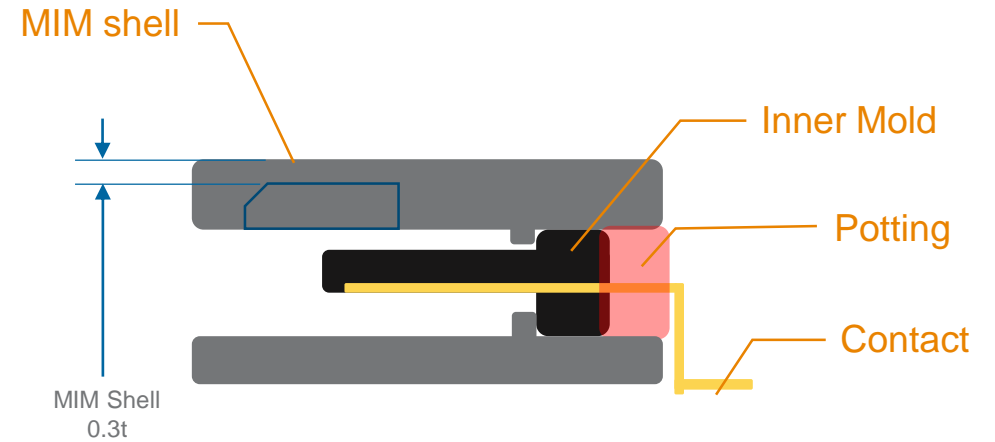

$$\begin{aligned}
 & \text{Height} = 1.88 \text{ (Plug)} \\
 & 0.9 \text{ (Shell Top \& Lock Lever Hole Bottom)} \\
 & 0.3 \text{ (Shell Bottom)} \\
 & \hline
 & + \\
 & = 3.08 \text{ (Min. requirement Height)}
 \end{aligned}$$

**= 3.08 (Min. requirement Height)**

# Why a MIM shell? High Wrenching Force

Wrenching Forces

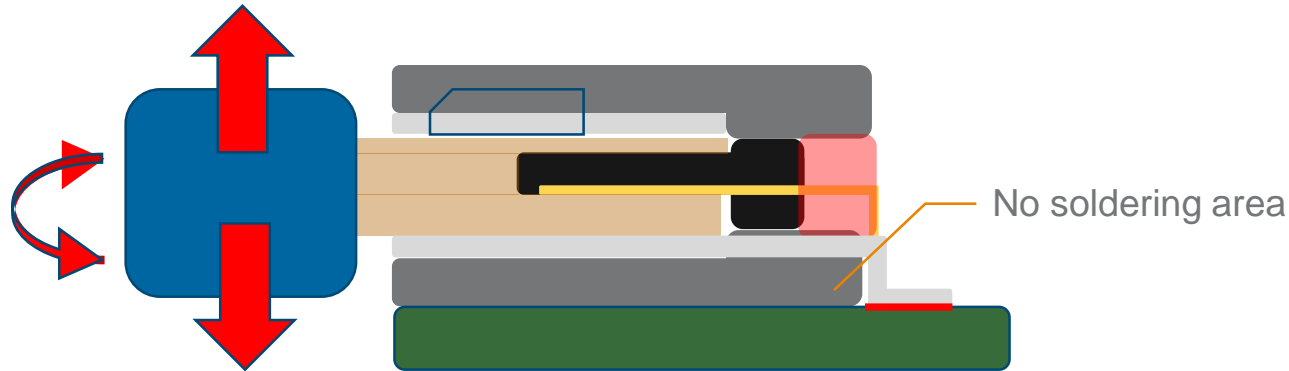

## Over-molded Shell Design

### Stamped and formed

Body is composed of separate metal shell and over molding  
Design is not resistant against wrenching forces  
Separation of shell from over-molding  
If Over mold is damaged, shell will also be damaged

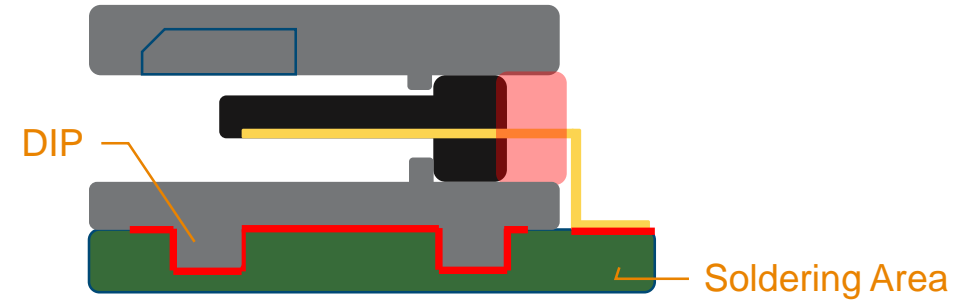

## MIM Shell Design

### MIM Design

Body is one metal component by MIM which is strong in mechanical tests.  
In addition, the DIP is also part of the body.  
Soldering strength is strong

The MIM shell design provides a full metal shell featuring higher tensile strength and the ability to solder the product at the very bottom. This results in a wrenching strength of >10N which is exceptionally strong compared to a normal micro USB connector (USB spec min. 50N)

# Contact TE

Product Overview Web Page: <http://www.te.com/catalog/minf/en/968>

Product Enquiry: Stellinga, Egbert [estellinga@te.com](mailto:estellinga@te.com)

Find Other Micro USB 2.0 Products: <http://www.te.com/catalog/menu/en/24505?BML=10576%2c17770>

© 2014 TE Connectivity Ltd. family of companies. All Rights Reserved. TE Connectivity and the TE connectivity (logo) are trademarks. Other logos, product and/or company names might be trademarks of their respective owners.

While TE has made every reasonable effort to ensure the accuracy of the information in this brochure, TE does not guarantee that it is error-free, nor does TE make any other representation, warranty or guarantee that the information is accurate, correct, reliable or current. TE reserves the right to make any adjustments to the information contained herein at any time without notice. TE expressly disclaims all implied warranties regarding the information contained herein, including, but not limited to, any implied warranties of merchantability or fitness for a particular purpose. The dimensions in this catalog are for reference purposes only and are subject to change without notice. Specifications are subject to change without notice. Consult TE for the latest dimension and design specifications.

