

# Company Profile

## Company Profile

Switchlab Inc. was founded in 1988. We are now the professional leading manufacturer of electric machinery switches and terminal blocks in Taiwan.

Switchlab Inc. over the years has constantly developed European type switches, Japanese type terminal blocks, and some of European type terminal blocks to meet market demand. Meanwhile, the electric machinery market is growing up fast. Switchlab Inc. invested large sums yearly in technical development and procedure improvement. We develop lots of new models every year, such as European type terminal blocks for PCB application and connection. Therefore, our products can meet all customer requests; we get good feedback from famous companies in worldwide. That's why our business is growing up stably.

Before establishment, Switchlab R&D team, we gathered, had many years of industry experience. That's why we could start this business of switches & terminal blocks quickly, and create the trademark "DECA". We would like to meet total solution demand from customers, so we have our own departments for injection, molding, stamping and mechanical equipments in house started from 1995. This allows us to speed product development and control quality stability; therefore we can meet customer requirements in price, quality, & delivery.

With over 20 years of experience in the development of electric machinery products, Switchlab becomes a leading manufacturer of professional illuminated pushbutton switches, particular switches, & terminal connection in Taiwan. Our products, not only switches but also terminal blocks, dominate more than 50% market share in the industrial field of Taiwan. Based on experienced R&D team & full-integrated production process, we create many new products available on market every year. That's why we are able to be OEM/ODM for famous companies in worldwide.

Keeping back in Taiwan, getting foothold in mainland China, taking a broad view are Switchlab main goals of business operation. Switchlab sales turnover is growing up every year. Especially, our creation of technology & stability of quality are higher than any other Asian supplier in this filed very much. This is our end mission to provide best services, competitive price & highest quality to all customers, and then we can grow up together with our customer prosperously.

## 公司簡介

進聯工業股份有限公司 (Switchlab Inc.) 成立於 1988 年，為亞洲著名電機開關、電子端子連接器的專業生產製造廠。

進聯公司成立以來為因應市場需求，持續不斷地開發歐式電機開關、日式端子以及部份歐式PCB 端子。並鑑於當時電機市場榮景，進聯工業逐年提撥資金，不斷突破開發技術和製造，每年開發多種新機種，如電機電子開關、歐式PCB 端子及連接器，滿足所有客戶需求，獲得國際大廠青睞，生意卓著。

本公司成立之前，進聯工業的公司技術團隊即具備相當豐富的實戰經驗，因此當進入電機開關和電子端子連接器生產領域時，進聯工業即能以非常快的速度發展此事業，成立自有品牌 DECA。同時，為了滿足客戶全方位需求，於 1995 年後，陸續成立射出，塑模，沖模，及機械等製造部門，更加速產品開發及品質的控制，進而滿足客戶價格、品質、與交期。

累積超過 20 餘年的電機產品研發經驗，進聯工業已成為台灣照光式專業按鈕開關、特殊開關、端子連結器之專業領導廠。目前我們的產品，不論是按鈕開關或端子，在台灣工業領域的市場佔有率，已超過 50%以上。由於我們資深研發團隊，和堅強生產陣容，因應市場需求，每年不斷有數十種新產品開發問市，也因此進聯工業能承接每年大量來自不同國家所下的OEM/ODM 訂單。

根留台灣，立足大陸，放眼天下，是進聯工業經營團隊的經營目標。進聯工業除了不斷地創造業績成長，更在技術創新和品質穩定性方面，持續超出亞洲同業大廠。進聯工業期許提供最佳服務，最好價格，及最高品質，與客戶共同成長，為公司最終目標。

# Global Network Services



上海廠 Shanghai Factory



深圳廠 Shenzhen Factory

## 各分公司據點

## REGIONAL MANUFACTURING CENTERS

### Taiwan Factory

進聯工業股份有限公司

SWITCHLAB INC.

台北縣 24243 新莊市中正路 66 號 8 樓  
8F., No. 66 Chung Cheng Rd., Hsin Chuang City,  
Taipei Hsien, Taiwan  
Zip Code: 24243  
Tel: +886-2-29968270  
Fax: +886-2-29966947  
E-mail: [deca@deca.com.tw](mailto:deca@deca.com.tw)  
<http://www.deca-switchlab.com>

### Shenzhen Factory

高誠電子(深圳)有限公司

GAOCHENG ELECTRONICS CO., LTD.

深圳市寶安區 518104 沙井鎮步涌工業 B 區第 15 棟  
No.15 Building, B Area, Buyong Ind., Shajing Town,  
Baoan District, Shenzhen City, Guangdong, China  
Zip Code: 518104  
Tel: +86-755-27239633, 27239733  
Fax: +86-755-27239833  
E-mail: [szsales@decatech.com](mailto:szsales@decatech.com)



五股三廠  
Taipei Factory (3)



台灣廠 Taiwan Factory  
台北一廠  
Taipei Factory (1)



台北二廠  
Taipei Factory (2)

### Shanghai Factory

進聯電子科技(上海)有限公司

上海市嘉定區 201801 馬陸鎮豐饒路 169 號  
No. 169 Feng Rao Rd., Malu Town, Jiading Area,  
Shanghai City, China  
Zip Code: 201801  
Tel: +86-21-69150100, 69150200  
Fax: +86-21-69157811  
E-mail: shsales@decatech.com

# Professional Services

## Perfect Customer Service

SwitchLab has a well-established global distribution network that provides a presence in all parts of the world electronic manufacturing take place. This allows for any customer's problem to be handled and solved in the shortest time.

## Efficient Service Process

SwitchLab has good ability to support our customers in design consultation, molding developing, and production. Most of molding components and product parts are made in house. In the field of electric machinery industry, there are seldom companies to have such complete production equipments same as SwitchLab. Because of these advantages, SwitchLab can handle all production cost & procedure control to compete with European & American worldwide companies for price & quality.

## 完善的客戶服務

進聯工業建立良好的全球經銷網，在世界電子生產領域占有一席之地，能在最短時間內，圓滿解決客戶所有問題。

## 高效的服務流程

進聯工業從設計諮詢、模具開發、製作、試模、量產等，全程所需的模具零件和成品零件，幾乎都是由本公司廠內全程加工製作完成。在目前電機業界，同業間能夠與本公司如此完整生產體系相較者，可謂屈指可數。所以進聯工業能夠自主掌控所有生產成本和製程管控，媲美歐美大廠的價格及品質。

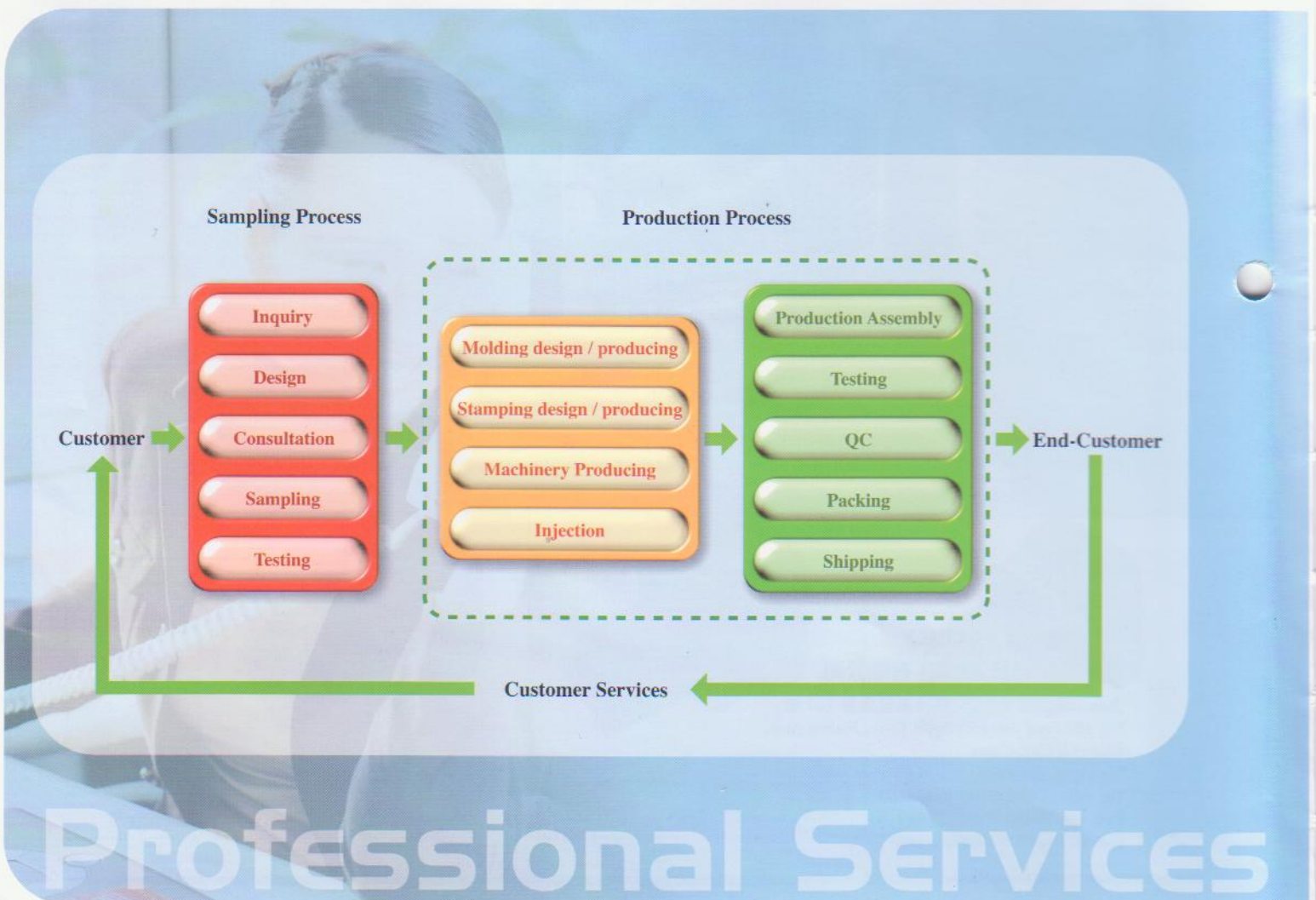

# Procedure Quality

## Procedure Quality

SwitchLab pay much attention to "Quality Assurance". We have full-integrated production equipments, so the whole production process, including injection, stamping, assembly, are all in control by us. We realize product design, sample design, and function test according to customer requests. Meanwhile, we provide powerful technical support and complete quality test to ensure high quality.

## 製程品質

進聯工業非常重視「品質保證」，本公司有相當完整的製程設備，在整個工藝流程上，包含射出、沖壓、組立全在本公司生產團隊掌控之中。根據客戶的要求完成產品設計、樣品設計、功能測試，提供強而有力的技術支援，以及完整的品質測試，進而保障優質品質。



射出部門 Injection



模具部門 Molding



沖壓部門 Stamping



品管部門 QC



大陸組立線  
China Assembly Line



台北組立線  
Taipei Assembly Line

# Products Quality

## Products Quality

Accumulating over 20 years of experience in the precision mold of plastic injection, the metal stamping and mass production, Switchlab is very professional in mold manufacturing, in life time extension of mold, in production precision, in shortening of development time, in productivity improvement, in R & D cost reduction . We have many testing equipments, and cooperate with some research institutes to check the developing results and quality. Therefore, the ability to adapt to rapidly changing customer demands and market conditions. All these backgrounds allow us to be able to develop the more precision & complex products for our customers in the near future.

To ensure contact and consistent communication within SwitchLab itself, we have set up ADSL and ISDN video conferencing system. We hope to extend this function to customers in the future to promote greater interaction.

## 生產品質

在累積超過 20 年豐富的精密塑膠射出模具、金屬沖壓、大量生產及相關領域的經驗下，進聯工業熟悉如何以經濟效益製作模具，如何增加模具壽命，如何使產品更精密，如何縮短研發時間，如何使生產更有效率，如何減低開發成本之能力。此外，我們更有許多精密的測試儀器，加上和研究機構合作，共同檢驗研發的成果及品質，所以我們有能力適應客戶快速改變的需求及市場的趨勢。這些經驗和技術背景，使我們有能力在未來為客戶開發更精密、更複雜的產品。

除此之外，進聯工業為了讓本公司所有工廠聯繫便捷、快速、無障礙，特別安裝網路視訊系統，建立綿密的溝通管道，隨時提供客戶最有效、最快速、最準確的溝通與服務。



Products Quality



# 目錄

## Index of Contents

公司簡介 (Company Profile) . . . . .	01 - 06
產品特色(Product Characteristic) . . . . .	08
產品索引 (Product Index) . . . . .	09 - 16
緊急停止開關 (Emergency Stop Switches) . . . . .	17 - 18
照光緊急停止開關 (Illuminated Emergency Stop Switches) . . . . .	19 - 20
按鈕開關 (Pushbuttons) . . . . .	21 - 26
指示燈 (Pilot Lights) . . . . .	27 - 35
照光按鈕開關 (Illuminated Pushbuttons) . . . . .	36 - 41
選擇開關(Selector Switches) . . . . .	42 - 48
照光選擇開關(Illuminated Selector Switches) . . . . .	49 - 55
鑰匙選擇開關 (Key Selector Switches) . . . . .	56 - 62
開關操作部 (Switches Operators) . . . . .	63 - 71
金屬鑲嵌框按鈕開關(Metal Bezels Pushbuttons) . . . . .	72 - 75
金屬鑲嵌框照光按鈕開關(Metal Bezels Illuminated Pushbuttons) . . . . .	76 - 79
金屬鑲嵌框選擇開關 (Metal Bezels Selector Switches) . . . . .	80 - 86
金屬鑲嵌框照光選擇開關 (Metal Bezels Illuminated Selector Switches) . . . . .	87 - 93
金屬鑲嵌框鑰匙選擇開關(Metal Bezels Key Selector Switches) . . . . .	94 - 100
開關操作部 (Switches Operators) . . . . .	101-105
配件 (Accessory) . . . . .	106-113
使用說明及注意事項(Use Instruction & Matters for Attention) . . . . .	114-117
詢價單(Inquiry Form) . . . . .	119
訂購單(Order Form) . . . . .	120

## Ø22 A20系列特點

體型小、重量輕

手指安全型螺絲端子

保護結構：IP20(IEC60529)

組合式接點塊使安裝和拆卸更方便

指示燈採用大燈罩，確保更廣闊的視角週圍，增強了安全性

按鈕、燈罩及護罩均為磨光表面，降低因周圍光線引起的反光

依照UL、C-UL、CCC（緊急停止開關除外）設計標準（認證中）

，符合EN標準。



UL508、CSA C22.2 No.14、  
EN60947-1、EN60947-5-1  
GB14048.5  
(認證中)



### ●接點容量

額定絕緣電壓		600V			
額定端子電流		10A			
使用電壓		24V	120V	240V	380V
AC 50/60Hz	電阻性負載(AC-12)	10A	10A	6A	2A
	電感性負載(AC-15)	10A	6A	3A	1.9A
DC	電阻性負載(DC-12)	8A	2.2A	1.1A	—
	電感性負載(DC-13)	4A	1.1A	0.55A	—

· 最小適用負載[參考值] = 3V AC/DC · 3mA  
(可使用範圍取決於使用條件和負載類型)

### ●LED額定值

型號	額定電壓	消耗電流	顏色記號
LAED-6①	6V AC/DC	10mA(A、R、Y) 7mA(G、PW、S)	A (琥珀色) G (綠色) PW (純白色)
LAED-1①	12V AC/DC	14mA(A、R、Y) 13mA(G、PW、S)	
LAED-2①	24V AC/DC	14mA(A、R、Y) 13mA(G、PW、S)	R (紅色) S (藍色) Y (黃色)
LAED-H①	110V AC/DC	5.5mA	
LAED-M3①	230/240V AC/DC	2.7mA	

註：型號中的①為顏色記號。

黃色LED用於指示燈和照光按鈕開關的白色照光。

### ●白熾燈泡額定值

型號	額定電壓	消耗電流
LA-T6P	6V AC/DC	1W (6.3V)
LA-T8P	12V AC/DC	1W (18V)
LA-T3P	24V AC/DC	1W (30V)

### ●安裝孔尺寸圖 (mm)

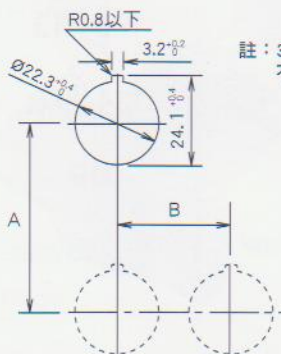

註：3.2mm的凹槽用於防止轉動，  
不使用銘板及防轉環時不需要。

元件	A(mm)	B(mm)
緊急停止開關	50以上	50以上
按鈕	50以上	30以上
選擇開關	50以上	40以上
蘑菇頭形按鈕開關	50以上	40以上
指示燈	30以上*	30以上



\*使用功率大於1W的燈泡時，應保留至少50mm的間距。

### ●性能規格



使用周圍溫度	-25 ~ +55° C (無結冰)
使用周圍濕度	45 ~ +85% (無結露)
儲存溫度	-45 ~ +85° C
保護結構	面板前：IP65(IEC 60529) 端子：IP20(IEC 60529)
絕緣電阻	100MΩ以上(500V DC高阻表)
耐電壓	接點塊：2,500V AC · 1分鐘 指示燈：2,000V AC · 1分鐘
耐振動	緊急停止開關 操作極限：10-500Hz 單振幅 0.35mm 加速度50m/s <sup>2</sup> 損壞極限：10-500Hz 單振幅 0.35mm 加速度50m/s <sup>2</sup> 指示燈、按鈕開關、照光按鈕開關及選擇開關 操作極限：5-55Hz 單振幅 0.5mm 損壞極限：30Hz 單振幅 1.5mm
抗衝擊性	緊急停止開關 操作極限：150 m/s <sup>2</sup> 損壞極限：1,000 m/s <sup>2</sup> 指示燈、按鈕開關、照光按鈕開關及選擇開關 操作極限：100 m/s <sup>2</sup> 損壞極限：1,000 m/s <sup>2</sup>
機械性 使用壽命	緊急停止開關：250,000 (僅單接點) 按鈕開關、照光按鈕開關 瞬時型：5,000,000(單接點) 1,000,000(雙接點) 交替型：250,000 (單接點) 100,000 (雙接點) 選擇開關：250,000 (單接點) 100,000 (雙接點)
電氣性 使用壽命	緊急停止開關：100,000 (僅單接點) 按鈕開關：250,000 (單接點) 100,000 (雙接點) 選擇開關：250,000 (單接點) 100,000 (雙接點)

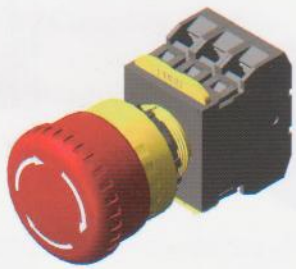

緊急停止開關 (Emergency Stop Switches)

No.	φ 40mm 蘑菇頭形 (Mushroom φ 40mm)		
Photo			
Approval	c  us (Pending)		
Page	18		

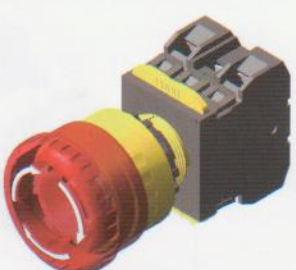
照光緊急停止開關 (Illuminated Emergency Stop Switches)

No.	φ 40mm 蘑菇頭形 (Mushroom φ 40mm)		
Photo			
Approval	c  us (Pending)		
Page	20		

按鈕開關 (Pushbuttons)



No.	平頭形 (Flush)	凸頭形 (Extended)	φ 40mm 蘑菇頭形 (Mushroom φ 40mm)
Photo			
Approval	c  us (Pending)	c  us (Pending)	c  us (Pending)
Page	22	23	24

按鈕開關 (Pushbuttons)



No.	金屬框圓形平頭 (Flush with Metal Bezel)	金屬鑲嵌框圓形平頭 (Flush with Metal Silhouette)	
Photo			
Approval	cULus (Pending)	cULus (Pending)	
Page	25	26	

指示燈 (Pilot Lights)

No.	平頭形 / 全電壓型 (Flush / Full Voltage)	平頭形 / 變壓器型 (Flush / Transformer Type)	平頭形(記名式) / 全電壓型 (Flush Marking Type / Full Voltage)
Photo			
Approval	cULus (Pending)	cULus (Pending)	cULus (Pending)
Page	28	29	30

No.	平頭形(記名式) / 變壓器型 (Flush Marking Type / Transformer Type)	凸頭形 / 全電壓型 (Extended / Full Voltage)	凸頭形 / 變壓器型 (Extended / Transformer Type)
Photo			
Approval	cULus (Pending)	cULus (Pending)	cULus (Pending)
Page	31	32	33

指示燈 (Pilot Lights)

No.	半球形 / 全電壓型 (Dome / Full Voltage)	半球形 / 變壓器型 (Dome / Transformer Type)
Photo		
Approval	cUL <sup>us</sup> (Pending)	cUL <sup>us</sup> (Pending)
Page	34	35



照光按鈕開關 (Illuminated Pushbuttons)



No.	圓形凸頭 (Extended)	全護圍圓形凸頭 (Extended with Full Shroud)	φ 40mm 蘑菇頭形 (Mushroom φ 40mm)
Photo			
Approval	cUL <sup>us</sup> (Pending)	cUL <sup>us</sup> (Pending)	cUL <sup>us</sup> (Pending)
Page	37	38	39

No.	金屬框圓形平頭 (Flush with Metal Bezel)	金屬鑲嵌框圓形平頭 (Flush with Metal Silhouette)
Photo		
Approval	cUL <sup>us</sup> (Pending)	cUL <sup>us</sup> (Pending)
Page	40	41



# Ø22 A20 系列控制元件

## 選擇開關 (Selector Switches)

No.	90° -2位置 / 交替型標準旋鈕 (90° -2 Position / Knob Type with Maintained)	90° -2位置 / 右復歸型標準旋鈕 (90° -2 Position / Knob Type with Spring Return from Right)	45° -3位置 / 交替型標準旋鈕 (45° -3 Position / Knob Type with Maintained)
Photo			
Approval	cULus (Pending)	cULus (Pending)	cULus (Pending)
Page	43	44	45

No.	45° -3位置 / 右復歸型標準旋鈕 (45° -3 Position / Knob Type with Spring Return from Right)	45° -3位置 / 左復歸型標準旋鈕 (45° -3 Position / Knob Type with Spring Return from Left)	45° -3位置 / 雙向復歸型標準旋鈕 (45° -3 Position / Knob Type with Spring Return from Tow-Way)
Photo			
Approval	cULus (Pending)	cULus (Pending)	cULus (Pending)
Page	46	47	48

## 照光選擇開關 (Illuminated Selector Switches)



No.	90° -2位置 / 交替型標準旋鈕 (90° -2 Position / Knob Type with Maintained)	90° -2位置 / 右復歸型標準旋鈕 (90° -2 Position / Knob Type with Spring Return from Right)	45° -3位置 / 交替型標準旋鈕 (45° -3 Position / Knob Type with Maintained)
Photo			
Approval	cULus (Pending)	cULus (Pending)	cULus (Pending)
Page	50	51	52

照光選擇開關 (Illuminated Selector Switches)



No.	45° -3位置 / 右復歸型標準旋鈕 (45° -3 Position / Knob Type with Spring Return from Right)	45° -3位置 / 左復歸型標準旋鈕 (45° -3 Position / Knob Type with Spring Return from Left)	45° -3位置 / 雙向復歸型標準旋鈕 (45° -3 Position / Knob Type with Spring Return from Tow-Way)
Photo			
Approval	cUL <sup>us</sup> (Pending)	cUL <sup>us</sup> (Pending)	cUL <sup>us</sup> (Pending)
Page	53	54	55

鑰匙選擇開關 (Key Selector Switches)

No.	90° -2位置 / 交替型 (90° -2 Position / Maintained)	90° -2位置 / 右復歸型 (90° -2 Position / Spring Return from Right)	45° -3位置 / 交替型 (45° -3 Position / Maintained)
Photo			
Approval	cUL <sup>us</sup> (Pending)	cUL <sup>us</sup> (Pending)	cUL <sup>us</sup> (Pending)
Page	57	58	59

No.	45° -3位置 / 右復歸型 (45° -3 Position / Spring Return from Right)	45° -3位置 / 左復歸型 (45° -3 Position / Spring Return from Left)	45° -3位置 / 雙向復歸型 (45° -3 Position / Spring Return from Tow-Way)
Photo			
Approval	cUL <sup>us</sup> (Pending)	cUL <sup>us</sup> (Pending)	cUL <sup>us</sup> (Pending)
Page	60	61	62



按鈕開關 (Pushbuttons)

No.	平頭形 (Flush)	凸頭形 (Extended)	φ 40mm 蘑菇頭形 (Mushroom φ 40mm)
Photo			
Approval	cULus (Pending)	cULus (Pending)	cULus (Pending)
Page	73	74	75





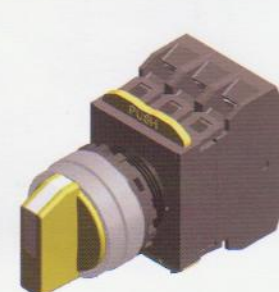

照光按鈕開關 (Illuminated Pushbuttons)

No.	圓形凸頭 (Extended)	全護圈圓形凸頭 (Extended with Full Shroud)	φ 40mm 蘑菇頭形 (Mushroom φ 40mm)
Photo			
Approval	cULus (Pending)	cULus (Pending)	cULus (Pending)
Page	77	78	79

選擇開關 (Selector Switches)

No.	90° -2位置 / 交替型標準旋鈕 (90° -2 Position / Knob Type with Maintained)	90° -2位置 / 右復歸型標準旋鈕 (90° -2 Position / Knob Type with Spring Return from Right)	45° -3位置 / 交替型標準旋鈕 (45° -3 Position / Knob Type with Maintained)
Photo			
Approval	cULus (Pending)	cULus (Pending)	cULus (Pending)
Page	81	82	83

選擇開關 (Selector Switches)

No.	45° -3位置 / 右復歸型標準旋鈕 (45° -3 Position / Knob Type with Spring Return from Right)	45° -3位置 / 左復歸型標準旋鈕 (45° -3 Position / Knob Type with Spring Return from Left)	45° -3位置 / 雙向復歸型標準旋鈕 (45° -3 Position / Knob Type with Spring Return from Tow-Way)
Photo			
Approval	c  us (Pending)	c  us (Pending)	c  us (Pending)
Page	84	85	86

照光選擇開關 (Illuminated Selector Switches)

No.	90° -2位置 / 交替型標準旋鈕 (90° -2 Position / Knob Type with Maintained)	90° -2位置 / 右復歸型標準旋鈕 (90° -2 Position / Knob Type with Spring Return from Right)	45° -3位置 / 交替型標準旋鈕 (45° -3 Position / Knob Type with Maintained)
Photo			
Approval	c  us (Pending)	c  us (Pending)	c  us (Pending)
Page	88	89	90

No.	45° -3位置 / 右復歸型標準旋鈕 (45° -3 Position / Knob Type with Spring Return from Right)	45° -3位置 / 左復歸型標準旋鈕 (45° -3 Position / Knob Type with Spring Return from Left)	45° -3位置 / 雙向復歸型標準旋鈕 (45° -3 Position / Knob Type with Spring Return from Tow-Way)
Photo			
Approval	c  us (Pending)	c  us (Pending)	c  us (Pending)
Page	91	92	93

鑰匙選擇開關 (Key Selector Switches)

No.	90° -2位置 / 交替型 (90° -2 Position / Maintained)	90° -2位置 / 右復歸型 (90° -2 Position / Spring Return from Right)	45° -3位置 / 交替型 (45° -3 Position / Maintained)
Photo			
Approval	c  us (Pending)	c  us (Pending)	c  us (Pending)
Page	95	96	97

No.	45° -3位置 / 右復歸型 (45° -3 Position / Spring Return from Right)	45° -3位置 / 左復歸型 (45° -3 Position / Spring Return from Left)	45° -3位置 / 雙向復歸型 (45° -3 Position / Spring Return from Tow-Way)
Photo			
Approval	c  us (Pending)	c  us (Pending)	c  us (Pending)
Page	98	99	100



開關構造說明 (Switch Construction Instructions)

A20B

緊急停止開關 (Emergency Stop Switches)

緊急停止開關  
(Emergency Stop Switches)  
Page.18

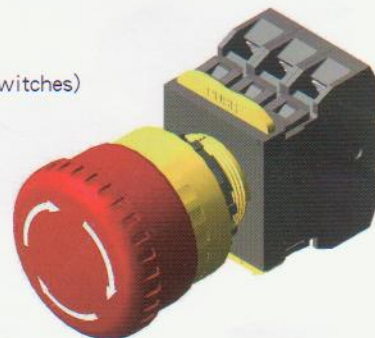

緊急停止開關操作部  
(Emergency Stop Switches  
Operators)  
Page.63



開關接點部  
(Contact Block  
Assemblies)  
Page.106-117

接點塊安裝轉接器  
(Contact Block  
Mounting Adapter)  
Page.109



接點塊  
(Contact Block)  
Page.108



接點塊  
(Contact Block)  
Page.108



接點塊  
(Contact Block)  
Page.108

# Ø22 A20 系列控制元件

## 緊急停止開關 (Emergency Stop Switches)

φ 40mm 蘑菇頭形 (Mushroom φ 40mm)

A20B

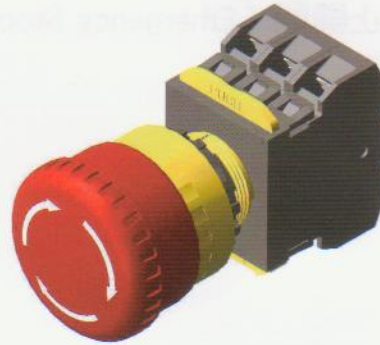

燈泡 (Illumination Type)	動作類型 (Operation)	接點結構 (Contacts)	型號 (Type No.)	使用電壓記號 (Operating Voltage Code)	顏色記號 (Lens Color Code)
無 (Without Lamp)	按鎖定拉出或 旋轉復歸 (Pushlock Pull/ Turn Reset)	1NC	A20B-V4E01R	無燈泡 (Without Lamp)	僅紅色 (Red only)
		2NC	A20B-V4E02R		
		3NC	A20B-V4E03R		
		1NO-1NC	A20B-V4E11R		
		1NO-2NC	A20B-V4E12R		
		2NO-1NC	A20B-V4E21R		

### ■外型尺寸 (Dimensions) mm

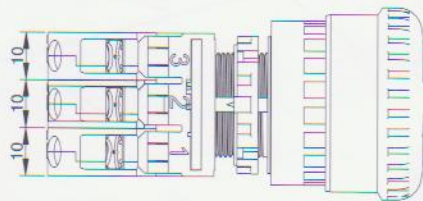

面板厚度 (Panel Thickness)  
0.8~6

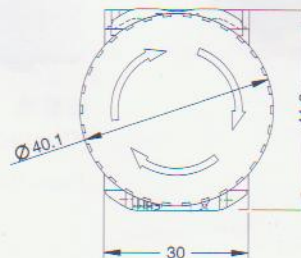
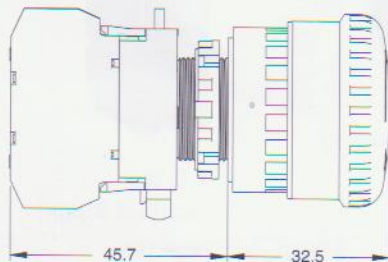

開關構造說明 (Switch Construction Instructions)

照光緊急停止開關 (Illuminated Emergency Stop Switches)

A20L

照光緊急停止開關 (Illuminated  
Emergency Stop Switches)  
Page.20

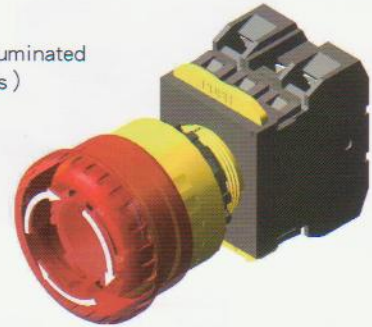

照光緊急停止開關操作部  
(Illuminated Emergency Stop  
Switches Operators)  
Page.63

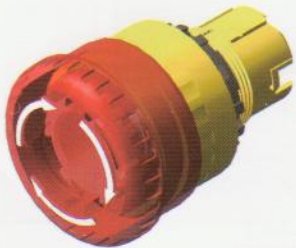

燈泡  
(Lamp)  
Page.110



開關接點部  
(Contact Block  
Assemblies)  
Page.106-107

接點塊安裝轉接器  
(Contact Block  
Mounting Adapter)  
Page.109



接點塊  
(Contact Block)  
Page.108



全電壓轉接器  
(Full Voltage  
Adapter)  
Page.109



接點塊  
(Contact Block)  
Page.108



# Ø22 A20 系列控制元件

## 照光緊急停止開關 (Illuminated Emergency Stop Switches)

φ 40mm 蘑菇頭形 (Mushroom φ 40mm)

A20L

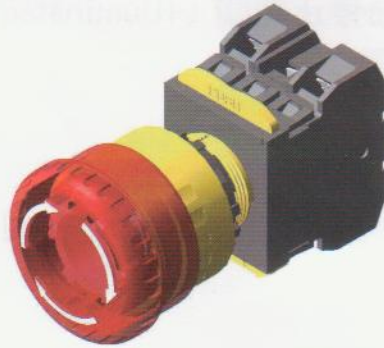

燈泡 (Illumination Type)	動作類型 (Operation)	接點結構 (Contacts)	型號 (Type No.)	使用電壓記號③ (Operating Voltage Code③)	顏色記號 (Lens Color Code)
無 (Without Lamp)	按鎖定拉出或 旋轉復歸(Push lock Pull/Turn Reset)	1NC	A20L-V4E01Q0R	0 (無燈泡) (Without Lamp) 最大(max.) 250V AC/DC	僅紅色 (Red only)
		2NC	A20L-V4E02Q0R		
		1NO-1NC	A20L-V4E11Q0R		
LED		1NC	A20L-V4E01Q③R	2 (6V AC/DC) 3 (12V AC/DC) 4 (24V AC/DC) H (110V AC/DC) M3 (230/240V AC/DC)	
		2NC	A20L-V4E02Q③R		
		1NO-1NC	A20L-V4E11Q③R		
白熾燈泡 (Incandescent)		1NC	A20L-V4E01Q③R	5 (6V AC/DC) 6 (12V AC/DC) 7 (24V AC/DC)	
		2NC	A20L-V4E02Q③R		
		1NO-1NC	A20L-V4E11Q③R		

### ■外型尺寸(Dimensions) mm

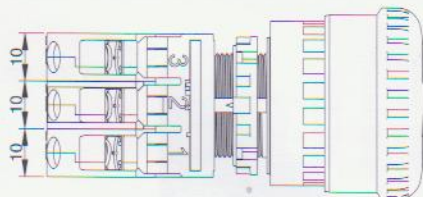

面板厚度 (Panel Thickness)  
0.8~6

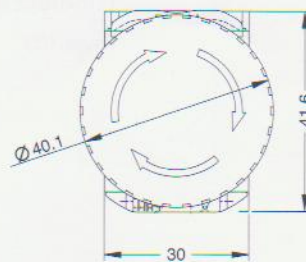
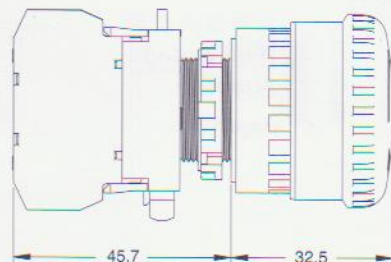

開關構造說明 (Switch Construction Instructions)

按鈕開關 (Pushbuttons)

A20B

按鈕開關  
(Pushbuttons)  
Page.22-26



按鈕開關操作部  
(Pushbutton Operators)  
Page.64-65



燈罩  
(Lens)  
Page.111



開關接點部  
(Contact Block  
Assemblies)  
Page.106-107



接點塊安裝轉接器  
(Contact Block  
Mounting Adapter)  
Page.109



接點塊  
(Contact Block)  
Page.108



接點塊  
(Contact Block)  
Page.108



接點塊  
(Contact Block)  
Page.108



# Ø22 A20 系列控制元件

## 按鈕開關 (Pushbuttons)

平頭形 (Flush)

A20B



燈泡 (Illumination Type)	動作類型 (Operation)	接點結構 (Contacts)	型號 (Type No.)	使用電壓記號 (Operating Voltage Code)	顏色記號① (Lens Color Code①)
無 (Without Lamp)	瞬時型 (Momentary)	1NO	A20B-M1E10①	無燈泡 (Without Lamp)	B: 黑色 G: 綠色 R: 紅色 S: 藍色 W: 白色 Y: 黃色
		1NC	A20B-M1E01①		
		2NO	A20B-M1E20①		
		2NC	A20B-M1E02①		
		1NO-1NC	A20B-M1E11①		
		3NO	A20B-M1E30①		
		3NC	A20B-M1E03①		
		2NO-1NC	A20B-M1E21①		
	1NO-2NC	A20B-M1E12①			
	交替型 (Maintained)	1NO	A20B-A1E10①		B: black G: green R: red S: blue W: white Y: yellow
		1NC	A20B-A1E01①		
		2NO	A20B-A1E20①		
		2NC	A20B-A1E02①		
		1NO-1NC	A20B-A1E11①		

### ■外型尺寸(Dimensions) mm

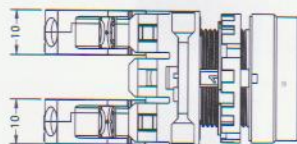

面板厚度 (Panel Thickness)  
0.8~6

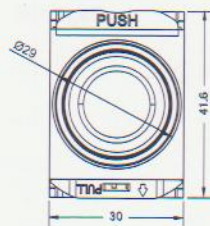
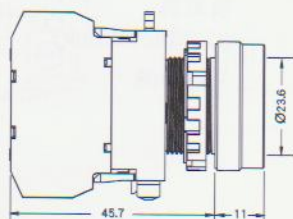

# Ø22 A20 系列控制元件

## 按鈕開關 (Pushbuttons)

凸頭形 (Extended)



A20B

燈泡 (Illumination Type)	動作類型 (Operation)	接點結構 (Contacts)	型號 (Type No.)	使用電壓記號 (Operating Voltage Code)	顏色記號① (Lens Color Code①)
無 (Without Lamp)	瞬時型 (Momentary)	1NO	A20B-M2E10①	無燈泡 (Without Lamp)	B : 黑色 G : 綠色 R : 紅色 S : 藍色 W : 白色 Y : 黃色
		1NC	A20B-M2E01①		
		2NO	A20B-M2E20①		
		2NC	A20B-M2E02①		
		1NO-1NC	A20B-M2E11①		
	交替型 (Maintained)	1NO	A20B-A2E10①		
		1NC	A20B-A2E01①		
		2NO	A20B-A2E20①		
		2NC	A20B-A2E02①		
		1NO-1NC	A20B-A2E11①		

### ■外型尺寸(Dimensions) mm

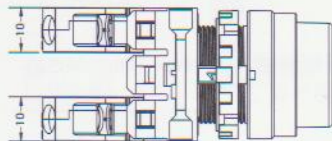

面板厚度 (Panel Thickness)  
0.8~6

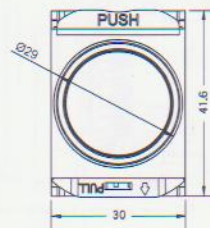
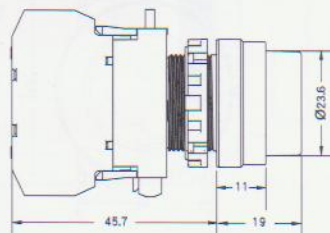

# Ø22 A20 系列控制元件

## 按鈕開關 (Pushbuttons)

φ 40mm 蘑菇頭形 (Mushroom φ 40mm)

A20B



燈泡 (Illumination Type)	動作類型 (Operation)	接點結構 (Contacts)	型號 (Type No.)	使用電壓記號 (Operating Voltage Code)	顏色記號① (Lens Color Code①)
無 (Without Lamp)	瞬時型 (Momentary)	1NO	A20B-M4E10①	無燈泡 (Without Lamp)	B: 黑色 G: 綠色 R: 紅色 S: 藍色 W: 白色 Y: 黃色
		1NC	A20B-M4E01①		
		2NO	A20B-M4E20①		
		2NC	A20B-M4E02①		
		1NO-1NC	A20B-M4E11①		
	交替型 (Maintained)	1NO	A20B-A4E10①		
		1NC	A20B-A4E01①		
		2NO	A20B-A4E20①		
		2NC	A20B-A4E02①		
		1NO-1NC	A20B-A4E11①		

B: 黑色  
G: 綠色  
R: 紅色  
S: 藍色  
W: 白色  
Y: 黃色

B: black  
G: green  
R: red  
S: blue  
W: white  
Y: yellow

### ■ 外型尺寸 (Dimensions) mm

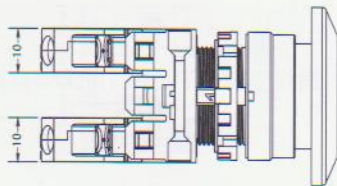

面板厚度 (Panel Thickness)  
0.8~6

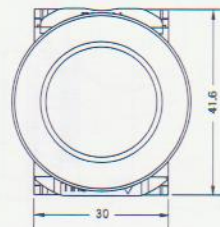
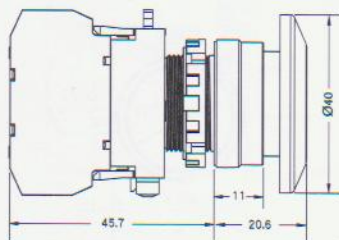



# Ø22 A20 系列控制元件

## 按鈕開關 (Pushbuttons)

金屬框圓形平頭 (Flush with Metal Bezel)



A20B

燈泡 (Illumination Type)	動作類型 (Operation)	接點結構 (Contacts)	型號 (Type No.)	使用電壓記號 (Operating Voltage Code)	顏色記號① (Lens Color Code①)
無 (Without Lamp)	瞬時型 (Momentary)	1NO	A20B-MS1E10①	無燈泡 (Without Lamp)	B: 黑色 G: 綠色 R: 紅色 S: 藍色 W: 白色 Y: 黃色
		1NC	A20B-MS1E01①		
		2NO	A20B-MS1E20①		
		2NC	A20B-MS1E02①		
		1NO-1NC	A20B-MS1E11①		
	交替型 (Maintained)	1NO	A20B-AS1E10①		
		1NC	A20B-AS1E01①		
		2NO	A20B-AS1E20①		
		2NC	A20B-AS1E02①		
		1NO-1NC	A20B-AS1E11①		

### ■外型尺寸(Dimensions) mm

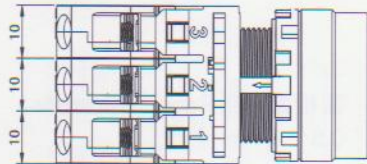

面板厚度 (Panel Thickness)  
0.8~6

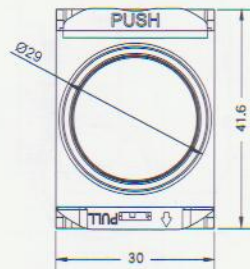
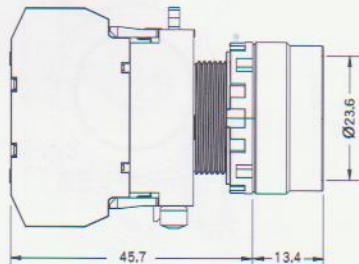

# Ø22 A20 系列控制元件

## 按鈕開關 (Pushbuttons)

金屬鑲嵌框圓形平頭 (Flush with Metal Silhouette)

A20B



燈泡 (Illumination Type)	動作類型 (Operation)	接點結構 (Contacts)	型號 (Type No.)	使用電壓記號 (Operating Voltage Code)	顏色記號① (Lens Color Code①)
無 (Without Lamp)	瞬時型 (Momentary)	1NO	A20B-MU1E10①	無燈泡 (Without Lamp)	B: 黑色 G: 綠色 R: 紅色 S: 藍色 W: 白色 Y: 黃色
		1NC	A20B-MU1E01①		
		2NO	A20B-MU1E20①		
		2NC	A20B-MU1E02①		
		1NO-1NC	A20B-MU1E11①		
	交替型 (Maintained)	1NO	A20B-AU1E10①		
		1NC	A20B-AU1E01①		
		2NO	A20B-AU1E20①		
		2NC	A20B-AU1E02①		
		1NO-1NC	A20B-AU1E11①		

### ■外型尺寸(Dimensions) mm

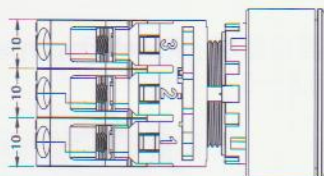

面板厚度 (Panel Thickness)  
0.8~6

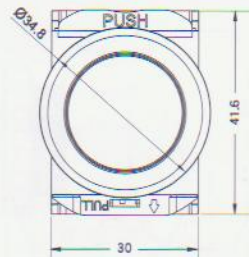
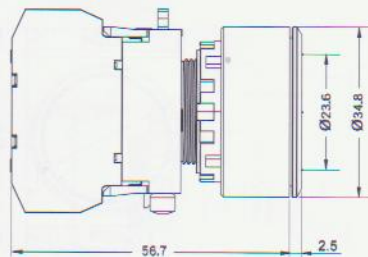

開關構造說明 (Switch Construction Instructions)

指示燈 (Pilot Lights)

A20P

指示燈  
(Pilot Lights)  
Page.28-35



指示燈操作部  
(Pilot Lights  
Operators)  
Page.66



燈泡  
(Lamp)  
Page.110



指示燈轉接器  
(Pilot Lights  
Adapter)  
Page.107

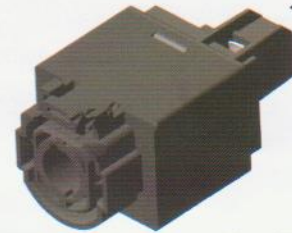

記名板  
(Marking Plate)  
Page.111

燈罩  
(Lens)  
Page.111



# Ø22 A20 系列控制元件

## 指示燈 (Pilot Lights)

平頭形 / 全電壓型 (Flush / Full Voltage)

A20P



燈泡 (Illumination Type)	動作電壓 (Operating Voltage)	型號 (Type No.)	顏色記號② (Lens Color Code②)
無 (Without Lamp)	最大(max.) 250V AC/DC	A20P-1EQ0②	A : 琥珀色      A : amber C : 透明色      C : clear G : 綠色          G : green R : 紅色          R : red S : 藍色          S : blue W : 乳白色      W : white Y : 黃色          Y : yellow
LED	6V AC/DC	A20P-1EQ2②	A : 琥珀色      A : amber G : 綠色          G : green PW : 純白色      PW : pure white R : 紅色          R : red S : 藍色          S : blue W : 乳白色      W : white Y : 黃色          Y : yellow 內置LED : LAED-③② (Built-in LED lamp)
	12V AC/DC	A20P-1EQ3②	
	24V AC/DC	A20P-1EQ4②	
	110V AC/DC	A20P-1EQH②	
	230/240V AC/DC	A20P-1EQM3②	
白熾燈泡 (Incandescent)	6V AC/DC	A20P-1EQ5②	A : 琥珀色      A : amber C : 透明色      C : clear G : 綠色          G : green R : 紅色          R : red S : 藍色          S : blue W : 乳白色      W : white Y : 黃色          Y : yellow 內置白熾燈泡 : LA-T③ (Built-in incandescent lamp)
	12V AC/DC	A20P-1EQ6②	
	24V AC/DC	A20P-1EQ7②	

### ■ 外型尺寸 (Dimensions) mm

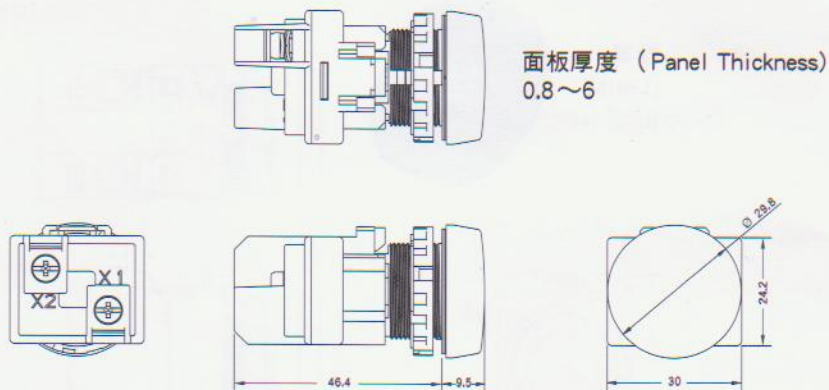

# Ø22 A20 系列控制元件

## 指示燈 (Pilot Lights)

平頭形 / 變壓器型 (Flush / Transformer Type)



A20P

燈泡 (Illumination Type)	動作電壓 (Operating Voltage)	型號 (Type No.)	顏色記號② (Lens Color Code②)
LED	100/110V AC	A20P-1EH2②	A : 琥珀色      A : amber G : 綠色        G : green PW : 純白色    PW : pure white R : 紅色        R : red S : 藍色        S : blue W : 乳白色     W : white Y : 黃色        Y : yellow 內置LED : LAED-6② (Built-in LED lamp)
	200/220V AC	A20P-1EM2②	
	115/120V AC	A20P-1EH22②	
	230/240V AC	A20P-1EM42②	
白熾燈泡 (Incandescent)	100/110V AC	A20P-1EH5②	A : 琥珀色      A : amber C : 透明色     C : clear G : 綠色        G : green R : 紅色        R : red S : 藍色        S : blue W : 乳白色     W : white Y : 黃色        Y : yellow 內置白熾燈泡 : LA-T6 (Built-in incandescent lamp)
	200/220V AC	A20P-1EM5②	
	115/120V AC	A20P-1EH25②	
	230/240V AC	A20P-1EM45②	

### ■外型尺寸(Dimensions) mm

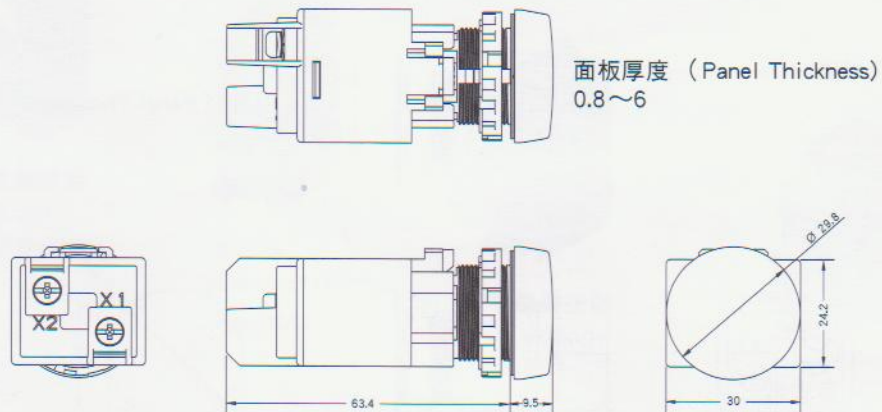

# Ø22 A20 系列控制元件

## 指示燈 (Pilot Lights)

平頭形(記名式) / 全電壓型 (Flush Marking Type / Full Voltage)

A20P



燈泡 (Illumination Type)	動作電壓 (Operating Voltage)	型號 (Type No.)	顏色記號② (Lens Color Code②)
無 (Without Lamp)	最大(max.) 250V AC/DC	A20P-1BEQ0②	A: 琥珀色      A: amber C: 透明色      C: clear G: 綠色          G: green R: 紅色          R: red S: 藍色          S: blue W: 乳白色      W: white Y: 黃色          Y: yellow
LED	6V AC/DC	A20P-1BEQ2②	A: 琥珀色      A: amber G: 綠色          G: green
	12V AC/DC	A20P-1BEQ3②	PW: 純白色      PW: pure white R: 紅色          R: red
	24V AC/DC	A20P-1BEQ4②	S: 藍色          S: blue W: 乳白色      W: white
	110V AC/DC	A20P-1BEQH②	Y: 黃色          Y: yellow
	230/240V AC/DC	A20P-1BEQM3②	內置LED: LAED-③② (Built-in LED lamp)
白熾燈泡 (Incandescent)	6V AC/DC	A20P-1BEQ5②	A: 琥珀色      A: amber C: 透明色      C: clear G: 綠色          G: green
	12V AC/DC	A20P-1BEQ6②	R: 紅色          R: red S: 藍色          S: blue W: 乳白色      W: white
	24V AC/DC	A20P-1BEQ7②	Y: 黃色          Y: yellow 內置白熾燈泡: LA-T③ (Built-in incandescent lamp)

### ■外型尺寸(Dimensions) mm

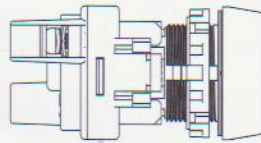

面板厚度 (Panel Thickness)  
0.8~6

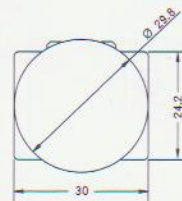
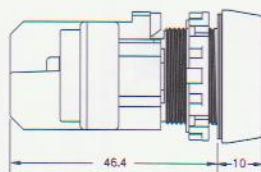
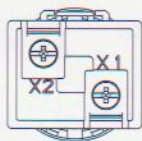

# Ø22 A20 系列控制元件

## 指示燈 (Pilot Lights)

平頭形(記名式) / 變壓器型 (Flush Marking Type / Transformer Type)



A20P

燈泡 (Illumination Type)	動作電壓 (Operating Voltage)	型號 (Type No.)	顏色記號② (Lens Color Code②)
LED	100/110V AC	A20P-1BEH2②	A : 琥珀色      A : amber G : 綠色        G : green PW : 純白色    PW : pure white R : 紅色         R : red S : 藍色         S : blue W : 乳白色     W : white Y : 黃色         Y : yellow  內置LED : LAED-6② (Built-in LED lamp)
	200/220V AC	A20P-1BEM2②	
	115/120V AC	A20P-1BEH22②	
	230/240V AC	A20P-1BEM42②	
白熾燈泡 (Incandescent)	100/110V AC	A20P-1BEH5②	A : 琥珀色      A : amber C : 透明色      C : clear G : 綠色        G : green R : 紅色         R : red S : 藍色         S : blue W : 乳白色     W : white Y : 黃色         Y : yellow  內置白熾燈泡 : LA-T6 (Built-in incandescent lamp)
	200/220V AC	A20P-1BEM5②	
	115/120V AC	A20P-1BEH25②	
	230/240V AC	A20P-1BEM45②	

### ■外型尺寸(Dimensions) mm

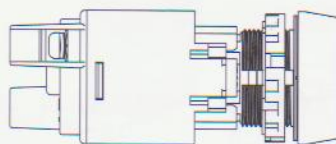

面板厚度 (Panel Thickness)  
0.8~6

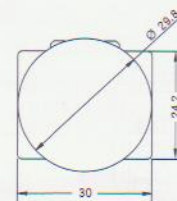
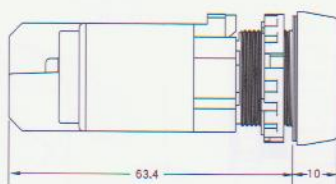
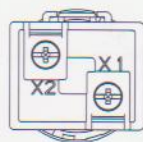

# Ø22 A20 系列控制元件

## 指示燈 (Pilot Lights)

凸頭形 / 全電壓型 (Extended / Full Voltage)

A20P



燈泡 (Illumination Type)	動作電壓 (Operating Voltage)	型號 (Type No.)	顏色記號② (Lens Color Code②)
無 (Without Lamp)	最大(max.) 250V AC/DC	A20P-2TEQ0②	A : 琥珀色      A : amber C : 透明色      C : clear G : 綠色          G : green R : 紅色          R : red S : 藍色          S : blue W : 乳白色      W : white Y : 黃色          Y : yellow
LED	6V AC/DC	A20P-2TEQ2②	A : 琥珀色      A : amber G : 綠色          G : green PW : 純白色      PW : pure white R : 紅色          R : red S : 藍色          S : blue W : 乳白色      W : white Y : 黃色          Y : yellow  內置LED : LAED-③② (Built-in LED lamp)
	12V AC/DC	A20P-2TEQ3②	
	24V AC/DC	A20P-2TEQ4②	
	110V AC/DC	A20P-2TEQH②	
	230/240V AC/DC	A20P-2TEQM3②	
白熾燈泡 (Incandescent)	6V AC/DC	A20P-2TEQ5②	A : 琥珀色      A : amber C : 透明色      C : clear G : 綠色          G : green R : 紅色          R : red S : 藍色          S : blue W : 乳白色      W : white Y : 黃色          Y : yellow  內置白熾燈泡 : LA-T③ (Built-in incandescent lamp)
	12V AC/DC	A20P-2TEQ6②	
	24V AC/DC	A20P-2TEQ7②	

### ■外型尺寸(Dimensions) mm

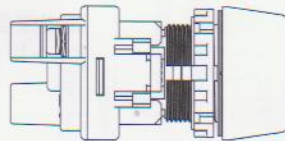

面板厚度 (Panel Thickness)  
0.8~6

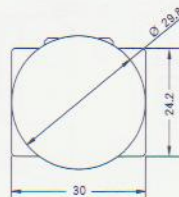
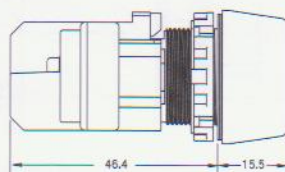
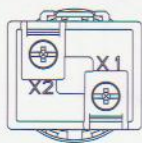



# Ø22 A20 系列控制元件

## 指示燈 (Pilot Lights)

凸頭形 / 變壓器型 (Extended / Transformer Type)

A20P



燈泡 (Illumination Type)	動作電壓 (Operating Voltage)	型號 (Type No.)	顏色記號② (Lens Color Code②)
LED	100/110V AC	A20P-2TEH2②	A : 琥珀色      A : amber G : 綠色      G : green PW : 純白色      PW : pure white R : 紅色      R : red S : 藍色      S : blue W : 乳白色      W : white Y : 黃色      Y : yellow
	200/220V AC	A20P-2TEM2②	內置LED : LAED-6② (Built-in LED lamp)
	115/120V AC	A20P-2TEH22②	
	230/240V AC	A20P-2TEM42②	
白熾燈泡 (Incandescent)	100/110V AC	A20P-2TEH5②	
	200/220V AC	A20P-2TEM5②	內置白熾燈泡 : LA-T6 (Built-in incandescent lamp)
	115/120V AC	A20P-2TEH25②	
	230/240V AC	A20P-2TEM45②	

### ■外型尺寸(Dimensions) mm

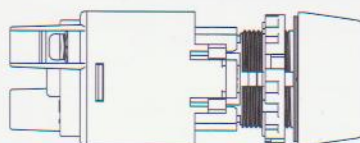

面板厚度 (Panel Thickness)  
0.8~6

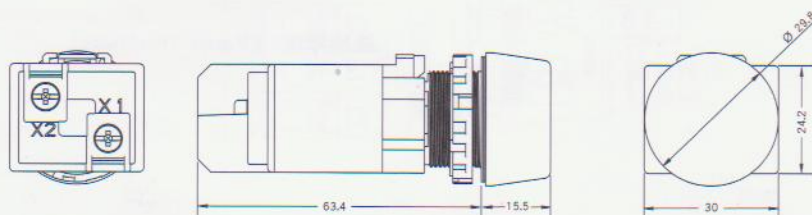

# Ø22 A20 系列控制元件

## 指示燈 (Pilot Lights)

半球形 / 全電壓型 (Dome / Full Voltage)

A20P



燈泡 (Illumination Type)	動作電壓 (Operating Voltage)	型號 (Type No.)	顏色記號② (Lens Color Code②)
無 (Without Lamp)	最大(max.) 250V AC/DC	A20P-2EQ0②	A : 琥珀色      A : amber C : 透明色      C : clear G : 綠色          G : green R : 紅色          R : red S : 藍色          S : blue W : 乳白色      W : white Y : 黃色          Y : yellow
LED	6V AC/DC	A20P-2EQ2②	A : 琥珀色      A : amber G : 綠色          G : green PW : 純白色      PW : pure white R : 紅色          R : red S : 藍色          S : blue W : 乳白色      W : white Y : 黃色          Y : yellow 內置LED : LAED-③② (Built-in LED lamp)
	12V AC/DC	A20P-2EQ3②	
	24V AC/DC	A20P-2EQ4②	
	110V AC/DC	A20P-2EQH②	
	230/240V AC/DC	A20P-2EQM3②	
白熾燈泡 (Incandescent)	6V AC/DC	A20P-2EQ5②	A : 琥珀色      A : amber C : 透明色      C : clear G : 綠色          G : green R : 紅色          R : red S : 藍色          S : blue W : 乳白色      W : white Y : 黃色          Y : yellow 內置白熾燈泡 : LA-T③ (Built-in incandescent lamp)
	12V AC/DC	A20P-2EQ6②	
	24V AC/DC	A20P-2EQ7②	

### ■外型尺寸(Dimensions) mm

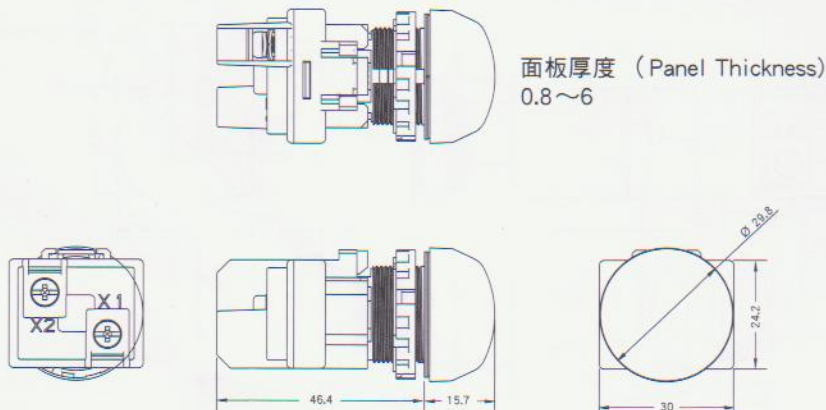

## 指示燈 (Pilot Lights)

半球形 / 變壓器型 (Dome / Transformer Type)



A20P

燈泡 (Illumination Type)	動作電壓 (Operating Voltage)	型號 (Type No.)	顏色記號② (Lens Color Code②)
LED	100/110V AC	A20P-2EH2②	A : 琥珀色      A : amber G : 綠色        G : green PW : 純白色    PW : pure white R : 紅色        R : red S : 藍色        S : blue W : 乳白色     W : white Y : 黃色        Y : yellow  內置LED : LAED-6② (Built-in LED lamp)
	200/220V AC	A20P-2EM2②	
	115/120V AC	A20P-2EH22②	
	230/240V AC	A20P-2EM42②	
白熾燈泡 (Incandescent)	100/110V AC	A20P-2EH5②	A : 琥珀色      A : amber C : 透明色     C : clear G : 綠色        G : green R : 紅色        R : red S : 藍色        S : blue W : 乳白色     W : white Y : 黃色        Y : yellow  內置白熾燈泡 : LA-T6 (Built-in incandescent lamp)
	200/220V AC	A20P-2EM5②	
	115/120V AC	A20P-2EH25②	
	230/240V AC	A20P-2EM45②	

### ■外型尺寸(Dimensions) mm

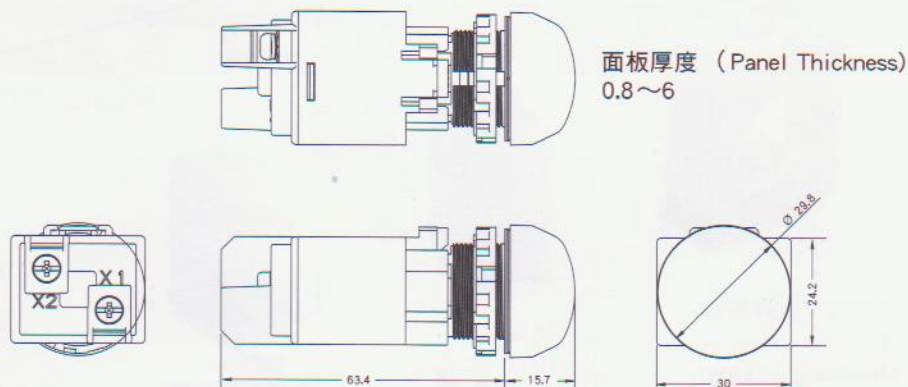

開關構造說明 (Switch Construction Instructions)

照光按鈕開關 (Illuminated Pushbuttons)

A20L

照光按鈕開關  
(Illuminated Pushbuttons)  
Page.37-41



照光按鈕開關操作部  
(Illuminated Pushbutton  
Operators)  
Page.67-68



燈泡  
(Lamp)  
Page.110



開關接點部  
(Contact Block  
Assemblies)  
Page.106-107

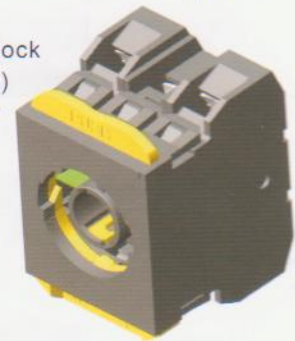

記名板  
(Marking Plate)  
Page.111



燈罩  
(Lens)  
Page.111



接點塊安裝轉接器  
(Contact Block  
Mounting Adapter)  
Page.109



接點塊  
(Contact Block)  
Page.108



全電壓轉接器  
(Full Voltage  
Adapter)  
Page.109



接點塊  
(Contact Block)  
Page.108



## 照光按鈕開關 (Illuminated Pushbuttons)

圓形凸頭 (Extended)



A20L

燈泡 (Illumination Type)	動作類型 (Operation)	接點結構 (Contacts)	型號 (Type No.)	使用電壓記號③ (Operating Voltage Code ③)	顏色記號② (Lens Color Code ②)
無 (Without Lamp)	瞬時型 (Momentary)	1NO	A20L-M2E10Q0②	0 (無燈泡) (Without Lamp) 最大(max.) 250V AC/DC	A : 琥珀色    A : amber G : 綠色        G : green R : 紅色        R : red S : 藍色        S : blue W : 乳白色     W : white Y : 黃色        Y : yellow
		1NC	A20L-M2E01Q0②		
		2NO	A20L-M2E20Q0②		
		2NC	A20L-M2E02Q0②		
		1NO-1NC	A20L-M2E11Q0②		
	交替型 (Maintained)	1NO	A20L-A2E10Q0②		
		1NC	A20L-A2E01Q0②		
		2NO	A20L-A2E20Q0②		
		2NC	A20L-A2E02Q0②		
		1NO-1NC	A20L-A2E11Q0②		
LED	瞬時型 (Momentary)	1NO	A20L-M2E10Q③②	2 (6V AC/DC) 3 (12V AC/DC) 4 (24V AC/DC) H (110V AC/DC) M3 (230/240V AC/DC)	A : 琥珀色    A : amber G : 綠色        G : green PW : 純白色    PW : pure white C : 透明色     C : clear R : 紅色        R : red S : 藍色        S : blue W : 乳白色     W : white Y : 黃色        Y : yellow  內置LED : LAED-③② (Built-in LED lamp)
		1NC	A20L-M2E01Q③②		
		2NO	A20L-M2E20Q③②		
		2NC	A20L-M2E02Q③②		
		1NO-1NC	A20L-M2E11Q③②		
	交替型 (Maintained)	1NO	A20L-A2E10Q③②		
		1NC	A20L-A2E01Q③②		
		2NO	A20L-A2E20Q③②		
		2NC	A20L-A2E02Q③②		
		1NO-1NC	A20L-A2E11Q③②		
白熾燈泡 (Incandescent)	瞬時型 (Momentary)	1NO	A20L-M2E10Q③②	5 (6V AC/DC) 6 (12V AC/DC) 7 (24V AC/DC)	A : 琥珀色    A : amber G : 綠色        G : green R : 紅色        R : red S : 藍色        S : blue W : 乳白色     W : white Y : 黃色        Y : yellow  內置白熾燈泡 : LA-T③ (Built-in incandescent lamp)
		1NC	A20L-M2E01Q③②		
		2NO	A20L-M2E20Q③②		
		2NC	A20L-M2E02Q③②		
		1NO-1NC	A20L-M2E11Q③②		
	交替型 (Maintained)	1NO	A20L-A2E10Q③②		
		1NC	A20L-A2E01Q③②		
		2NO	A20L-A2E20Q③②		
		2NC	A20L-A2E02Q③②		
		1NO-1NC	A20L-A2E11Q③②		

■外型尺寸(Dimensions) mm

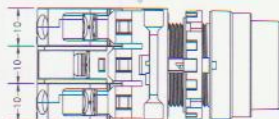

面板厚度 (Panel Thickness)  
0.8~6

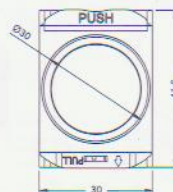
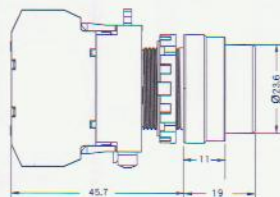

# Ø22 A20 系列控制元件

## 照光按鈕開關 (Illuminated Pushbuttons)

全護圈圓形凸頭 (Extended with Full Shroud)

A20L



燈泡 (Illumination Type)	動作類型 (Operation)	接點結構 (Contacts)	型號 (Type No.)	使用電壓記號③ (Operating Voltage Code③)	顏色記號② (Lens Color Code②)
無 (Without Lamp)	瞬時型 (Momentary)	1NO	A20L-MF2E10Q0②	0 (無燈泡) (Without Lamp) 最大(max.) 250V AC/DC	A : 琥珀色 G : 綠色 R : 紅色 S : 藍色 W : 乳白色 Y : 黃色  A : amber G : green R : red S : blue W : white Y : yellow
		1NC	A20L-MF2E01Q0②		
		2NO	A20L-MF2E20Q0②		
		2NC	A20L-MF2E02Q0②		
		1NO-1NC	A20L-MF2E11Q0②		
	交替型 (Maintained)	1NO	A20L-AF2E10Q0②		
		1NC	A20L-AF2E01Q0②		
		2NO	A20L-AF2E20Q0②		
		2NC	A20L-AF2E02Q0②		
		1NO-1NC	A20L-AF2E11Q0②		
LED	瞬時型 (Momentary)	1NO	A20L-MF2E10Q③②	2 (6V AC/DC) 3 (12V AC/DC) 4 (24V AC/DC) H (110V AC/DC) M3 (230/240V AC/DC)	A : 琥珀色 G : 綠色 PW : 純白色 C : 透明色 R : 紅色 S : 藍色 W : 乳白色 Y : 黃色  A : amber G : green PW : pure white C : clear R : red S : blue W : white Y : yellow  內置LED : LAED-③② (Built-in LED lamp)
		1NC	A20L-MF2E01Q③②		
		2NO	A20L-MF2E20Q③②		
		2NC	A20L-MF2E02Q③②		
		1NO-1NC	A20L-MF2E11Q③②		
	交替型 (Maintained)	1NO	A20L-AF2E10Q③②		
		1NC	A20L-AF2E01Q③②		
		2NO	A20L-AF2E20Q③②		
		2NC	A20L-AF2E02Q③②		
		1NO-1NC	A20L-AF2E11Q③②		
白熾燈泡 (Incandescent)	瞬時型 (Momentary)	1NO	A20L-MF2E10Q③②	5 (6V AC/DC) 6 (12V AC/DC) 7 (24V AC/DC)	A : 琥珀色 G : 綠色 R : 紅色 S : 藍色 W : 乳白色 Y : 黃色  A : amber G : green R : red S : blue W : white Y : yellow  內置白熾燈泡 : LA-T③ (Built-in incandescent lamp)
		1NC	A20L-MF2E01Q③②		
		2NO	A20L-MF2E20Q③②		
		2NC	A20L-MF2E02Q③②		
		1NO-1NC	A20L-MF2E11Q③②		
	交替型 (Maintained)	1NO	A20L-AF2E10Q③②		
		1NC	A20L-AF2E01Q③②		
		2NO	A20L-AF2E20Q③②		
		2NC	A20L-AF2E02Q③②		
		1NO-1NC	A20L-AF2E11Q③②		

### ■外型尺寸(Dimensions) mm

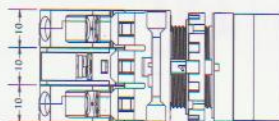

面板厚度 (Panel Thickness)  
0.8~6

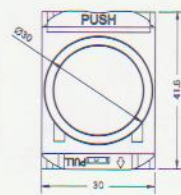
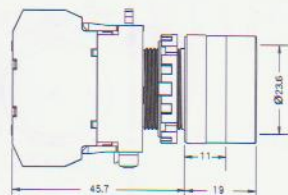

## 照光按鈕開關 (Illuminated Pushbuttons)

φ 40mm 蘑菇頭形 (Mushroom φ 40mm)



A20L

燈泡 (Illumination Type)	動作類型 (Operation)	接點結構 (Contacts)	型號 (Type No.)	使用電壓記號③ (Operating Voltage Code③)	顏色記號② (Lens Color Code②)
無 (Without Lamp)	瞬時型 (Momentary)	1NO	A20L-M4E10Q0②	0 (無燈泡) (Without Lamp) 最大(max.) 250V AC/DC	A: 琥珀色 G: 綠色 R: 紅色 S: 藍色 W: 乳白色 Y: 黃色  A: amber G: green R: red S: blue W: white Y: yellow
		1NC	A20L-M4E01Q0②		
		2NO	A20L-M4E20Q0②		
		2NC	A20L-M4E02Q0②		
		1NO-1NC	A20L-M4E11Q0②		
	交替型 (Maintained)	1NO	A20L-A4E10Q0②		
		1NC	A20L-A4E01Q0②		
		2NO	A20L-A4E20Q0②		
		2NC	A20L-A4E02Q0②		
		1NO-1NC	A20L-A4E11Q0②		
LED	瞬時型 (Momentary)	1NO	A20L-M4E10Q③②	2 (6V AC/DC) 3 (12V AC/DC) 4 (24V AC/DC) H (110V AC/DC) M3 (230/240V AC/DC)	A: 琥珀色 G: 綠色 PW: 純白色 R: 紅色 S: 藍色 W: 乳白色 Y: 黃色  A: amber G: green PW: pure white R: red S: blue W: white Y: yellow  內置LED: LAED-③② (Built-in LED lamp)
		1NC	A20L-M4E01Q③②		
		2NO	A20L-M4E20Q③②		
		2NC	A20L-M4E02Q③②		
		1NO-1NC	A20L-M4E11Q③②		
	交替型 (Maintained)	1NO	A20L-A4E10Q③②		
		1NC	A20L-A4E01Q③②		
		2NO	A20L-A4E20Q③②		
		2NC	A20L-A4E02Q③②		
		1NO-1NC	A20L-A4E11Q③②		
白熾燈泡 (Incandescent)	瞬時型 (Momentary)	1NO	A20L-M4E10Q③②	5 (6V AC/DC) 6 (12V AC/DC) 7 (24V AC/DC)	A: 琥珀色 G: 綠色 R: 紅色 S: 藍色 W: 乳白色 Y: 黃色  A: amber G: green R: red S: blue W: white Y: yellow  內置白熾燈泡: LA-T③ (Built-in incandescent lamp)
		1NC	A20L-M4E01Q③②		
		2NO	A20L-M4E20Q③②		
		2NC	A20L-M4E02Q③②		
		1NO-1NC	A20L-M4E11Q③②		
	交替型 (Maintained)	1NO	A20L-A4E10Q③②		
		1NC	A20L-A4E01Q③②		
		2NO	A20L-A4E20Q③②		
		2NC	A20L-A4E02Q③②		
		1NO-1NC	A20L-A4E11Q③②		

### ■ 外型尺寸 (Dimensions) mm

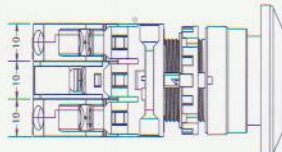

面板厚度 (Panel Thickness)  
0.8~6

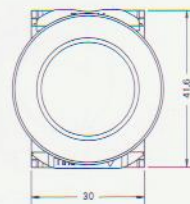
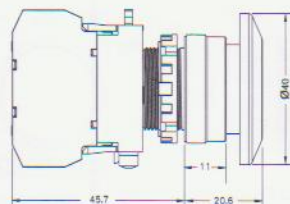

# Ø22 A20 系列控制元件

## 照光按鈕開關 (Illuminated Pushbuttons)

金屬框圓形平頭 (Flush with Metal Bezel)

A20L



燈泡 (Illumination Type)	動作類型 (Operation)	接點結構 (Contacts)	型號 (Type No.)	使用電壓記號③ (Operating Voltage Code③)	顏色記號② (Lens Color Code②)
無 (Without Lamp)	瞬時型 (Momentary)	1NO	A20L-MS1E10Q0②	0 (無燈泡) (Without Lamp) 最大(max.) 250V AC/DC	A: 琥珀色 G: 綠色 R: 紅色 S: 藍色 W: 乳白色 Y: 黃色  A: amber G: green R: red S: blue W: white Y: yellow
		1NC	A20L-MS1E01Q0②		
		2NO	A20L-MS1E20Q0②		
		2NC	A20L-MS1E02Q0②		
		1NO-1NC	A20L-MS1E11Q0②		
	交替型 (Maintained)	1NO	A20L-AS1E10Q0②		
		1NC	A20L-AS1E01Q0②		
		2NO	A20L-AS1E20Q0②		
		2NC	A20L-AS1E02Q0②		
		1NO-1NC	A20L-AS1E11Q0②		
LED	瞬時型 (Momentary)	1NO	A20L-MS1E10Q③②	2 (6V AC/DC) 3 (12V AC/DC) 4 (24V AC/DC) H (110V AC/DC) M3 (230/240V AC/DC)	A: 琥珀色 G: 綠色 PW: 純白色 C: 透明色 R: 紅色 S: 藍色 W: 乳白色 Y: 黃色  A: amber G: green PW: pure white C: clear R: red S: blue W: white Y: yellow  內置LED: LAED-③② (Built-in LED lamp)
		1NC	A20L-MS1E01Q③②		
		2NO	A20L-MS1E20Q③②		
		2NC	A20L-MS1E02Q③②		
		1NO-1NC	A20L-MS1E11Q③②		
	交替型 (Maintained)	1NO	A20L-AS1E10Q③②		
		1NC	A20L-AS1E01Q③②		
		2NO	A20L-AS1E20Q③②		
		2NC	A20L-AS1E02Q③②		
		1NO-1NC	A20L-AS1E11Q③②		
白熾燈泡 (Incandescent)	瞬時型 (Momentary)	1NO	A20L-MS1E10Q③②	5 (6V AC/DC) 6 (12V AC/DC) 7 (24V AC/DC)	A: 琥珀色 G: 綠色 R: 紅色 S: 藍色 W: 乳白色 Y: 黃色  A: amber G: green R: red S: blue W: white Y: yellow  內置白熾燈泡: LA-T③ (Built-in incandescent lamp)
		1NC	A20L-MS1E01Q③②		
		2NO	A20L-MS1E20Q③②		
		2NC	A20L-MS1E02Q③②		
		1NO-1NC	A20L-MS1E11Q③②		
	交替型 (Maintained)	1NO	A20L-AS1E10Q③②		
		1NC	A20L-AS1E01Q③②		
		2NO	A20L-AS1E20Q③②		
		2NC	A20L-AS1E02Q③②		
		1NO-1NC	A20L-AS1E11Q③②		

### 外型尺寸(Dimensions) mm

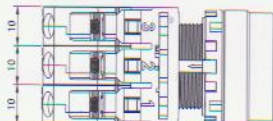

面板厚度 (Panel Thickness)  
0.8~6

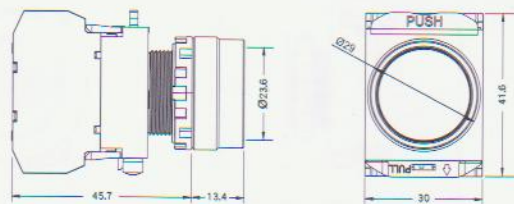



## 照光按鈕開關 (Illuminated Pushbuttons)

金屬鑲嵌框圓形平頭 (Flush with Metal Silhouette)



A20L

燈泡 (Illumination Type)	動作類型 (Operation)	接點結構 (Contacts)	型號 (Type No.)	使用電壓記號③ (Operating Voltage Code③)	顏色記號② (Lens Color Code②)
無 (Without Lamp)	瞬時型 (Momentary)	1NO	A20L-MU1E10Q0②	0 (無燈泡) (Without Lamp) 最大(max.) 250V AC/DC	A: 琥珀色      A: amber G: 綠色        G: green R: 紅色        R: red S: 藍色        S: blue W: 乳白色     W: white Y: 黃色        Y: yellow
		1NC	A20L-MU1E01Q0②		
		2NO	A20L-MU1E20Q0②		
		2NC	A20L-MU1E02Q0②		
		1NO-1NC	A20L-MU1E11Q0②		
	交替型 (Maintained)	1NO	A20L-AU1E10Q0②		
		1NC	A20L-AU1E01Q0②		
		2NO	A20L-AU1E20Q0②		
		2NC	A20L-AU1E02Q0②		
		1NO-1NC	A20L-AU1E11Q0②		
LED	瞬時型 (Momentary)	1NO	A20L-MU1E10Q3②	2 (6V AC/DC) 3 (12V AC/DC) 4 (24V AC/DC) H (110V AC/DC) M3 (230/240V AC/DC)	A: 琥珀色      A: amber G: 綠色        G: green PW: 純白色    PW: pure white C: 透明色     C: clear R: 紅色        R: red S: 藍色        S: blue W: 乳白色     W: white Y: 黃色        Y: yellow  內置 LED : LAED-③② (Built-in LED lamp)
		1NC	A20L-MU1E01Q3②		
		2NO	A20L-MU1E20Q3②		
		2NC	A20L-MU1E02Q3②		
		1NO-1NC	A20L-MU1E11Q3②		
	交替型 (Maintained)	1NO	A20L-AU1E10Q3②		
		1NC	A20L-AU1E01Q3②		
		2NO	A20L-AU1E20Q3②		
		2NC	A20L-AU1E02Q3②		
		1NO-1NC	A20L-AU1E11Q3②		
白熾燈泡 (Incandescent)	瞬時型 (Momentary)	1NO	A20L-MU1E10Q3②	5 (6V AC/DC) 6 (12V AC/DC) 7 (24V AC/DC)	A: 琥珀色      A: amber G: 綠色        G: green R: 紅色        R: red S: 藍色        S: blue W: 乳白色     W: white Y: 黃色        Y: yellow  內置白熾燈泡 : LA-T③ (Built-in incandescent lamp)
		1NC	A20L-MU1E01Q3②		
		2NO	A20L-MU1E20Q3②		
		2NC	A20L-MU1E02Q3②		
		1NO-1NC	A20L-MU1E11Q3②		
	交替型 (Maintained)	1NO	A20L-AU1E10Q3②		
		1NC	A20L-AU1E01Q3②		
		2NO	A20L-AU1E20Q3②		
		2NC	A20L-AU1E02Q3②		
		1NO-1NC	A20L-AU1E11Q3②		

### ■ 外型尺寸(Dimensions) mm

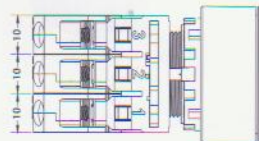

面板厚度 (Panel Thickness)  
0.8~6

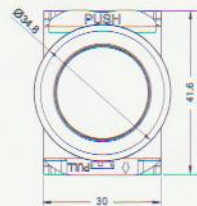
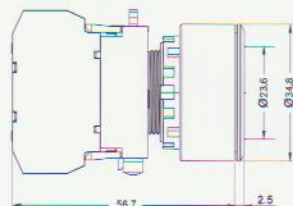

A20S

選擇開關 (Selector Switches)

選擇開關  
(Selector Switches)  
Page.43-48



選擇開關操作部  
(Selector Switches  
Operators)  
Page.69



開關接點部  
(Contact Block  
Assemblies)  
Page.106-107



接點塊安裝轉接器  
(Contact Block  
Mounting Adapter)  
Page.109



接點塊  
(Contact Block)  
Page.108



接點塊  
(Contact Block)  
Page.108



接點塊  
(Contact Block)  
Page.108



# Ø22 A20 系列控制元件

## 選擇開關 (Selector Switches)

90° -2位置 / 交替型標準旋鈕 (90° -2 Position / Knob Type with Maintained)



A20S

位置數 (No. of Positions)	接點結構 (Contacts)			旋鈕位置 (Operator Position)			型號 (Type No.)	使用電壓記號 (Operating Voltage Code)	顏色記號② (Lens Color Code②)	
	記號 (Configuration)	位置 (Mounting)	類型 (Position)	L	R	---				
90° -2位置 / 交替型標準 旋鈕 (90° -2 Position / Knob Type with Maintained)	1NO (10)	1	NO		●		A20S-2E10②	無燈泡 (Without Lamp)	blank : 黑色 G : 綠色 R : 紅色 S : 藍色 W : 白色 Y : 黃色	
		2								
		3								
	1NC (01)	1								A20S-2E01②
		2								
		3	NC	●						
	2NO (20)	1	NO		●		A20S-2E20②			
		2								
		3	NO		●					
	2NC (02)	1	NC			●	A20S-2E02②			
		2								
		3	NC	●						
1NO-1NC (11)	1	NO		●		A20S-2E11②				
	2									
	3	NC	●							
3NO (30)	1	NO		●		A20S-2E30②				
	2	NO		●						
	3	NO		●						
3NC (03)	1	NC	●			A20S-2E03②				
	2	NC	●							
	3	NC	●							
2NO-1NC (21)	1	NO		●		A20S-2E21②				
	2	NO		●						
	3	NC	●							
1NO-2NC (12)	1	NO		●		A20S-2E12②				
	2	NC	●							
	3	NC	●							

■外型尺寸(Dimensions) mm

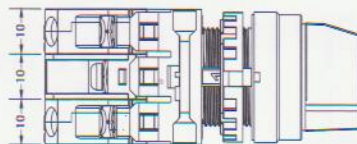

面板厚度 (Panel Thickness)  
0.8~6

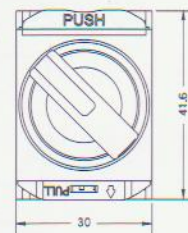
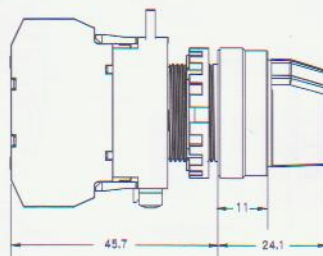

# Ø22 A20 系列控制元件

## 選擇開關 (Selector Switches)

90° -2位置 / 右復歸型標準旋鈕 (90° -2 Position / Knob Type with Spring Return from Right)

A20S



位置數 (No. of Positions)	接點結構 (Contacts)			旋鈕位置 (Operator Position)			型號 (Type No.)	使用電壓記號 (Operating Voltage Code)	顏色記號② (Lens Color Code②)	
	記號 (Configuration)	位置 (Mounting)	類型 (Position)	L	R	---				
90° -2位置 / 右復歸型標準旋鈕 (90° -2 Position / Knob Type with Spring Return from Right)  L R	1NO (10)	1	NO		●		A20S-21E10②	無燈泡 (Without Lamp)	blank : 黑色 G : 綠色 R : 紅色 S : 藍色 W : 白色 Y : 黃色	
		2								
		3								
	1NC (01)	1								A20S-21E01②
		2			●					
		3	NC	●						
	2NO (20)	1	NO		●		A20S-21E20②			
		2			●					
		3	NO		●					
	2NC (02)	1	NC		●		A20S-21E02②			
		2			●					
		3	NC	●						
1NO-1NC (11)	1	NO		●		A20S-21E11②				
	2			●						
	3	NC	●							
3NO (30)	1	NO		●		A20S-21E30②				
	2	NO		●						
	3	NO		●						
3NC (03)	1	NC	●			A20S-21E03②				
	2	NC	●							
	3	NC	●							
2NO-1NC (21)	1	NO		●		A20S-21E21②				
	2	NO		●						
	3	NC	●							
1NO-2NC (12)	1	NO		●		A20S-21E12②				
	2	NC	●							
	3	NC	●							

### ■外型尺寸(Dimensions) mm

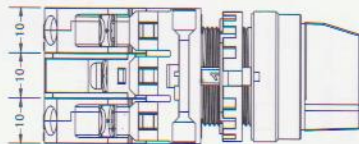

面板厚度 (Panel Thickness)  
0.8~6

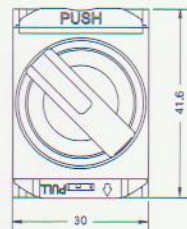
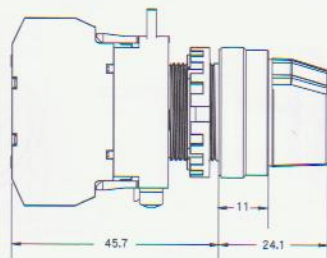

## 選擇開關 (Selector Switches)

45° -3位置 / 交替型標準旋鈕 (45° -3 Position / Knob Type with Maintained)



A20S

位置數 (No. of Positions)	接點結構 (Contacts)			旋鈕位置 (Operator Position)			型號 (Type No.)	使用電壓記號 (Operating Voltage Code)	顏色記號② (Lens Color Code②)
	記號 (Configuration)	位置 (Mounting)	類型 (Position)	L	C	R			
45° -3位置 / 交替型標準 旋鈕 (45° -3 Position / Knob Type with Maintained)  L C R ↓	2NO (20)	1 2 3	NO NO	●			A20S-3E20②	無燈泡 (Without Lamp)	blank : 黑色 G : 綠色 R : 紅色 S : 藍色 W : 白色 Y : 黃色  blank : black G : green R : red S : blue W : white Y : yellow
	2NO (20N1)	1 2 3	NO NO	●		●	A20S-3E20N1②		
	2NC (02)	1 2 3	NC NC		■		A20S-3E02②		
	2NC (02N1)	1 2 3	NC NC		●	●	A20S-3E02N1②		
	1NO-1NC (11)	1 2 3	NO NC	●			A20S-3E11②		
	1NO-1NC (11N1)	1 2 3	NO NO	●		●	A20S-3E11N1②		
	1NO-1NC (11N2)	1 2 3	NO NC	●		●	A20S-3E11N2②		
	1NO-1NC (11N3)	1 2 3	NO NC		●	●	A20S-3E11N3②		
	1NO-1NC (11N4)	1 2 3	NO NC	●		●	A20S-3E11N4②		
	3NO (30)	1 2 3	NO NO NO	●		●	A20S-3E30②		
	3NC (03)	1 2 3	NC NC NC		■		A20S-3E03②		
	2NO-1NC (21)	1 2 3	NO NC NO	●		●	A20S-3E21②		
	1NO-2NC (12)	1 2 3	NO NO NC	●		●	A20S-3E12②		

■外型尺寸(Dimensions) mm

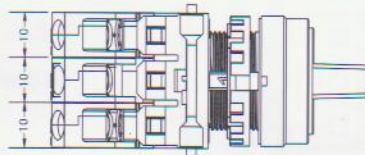

面板厚度 (Panel Thickness)  
0.8~6

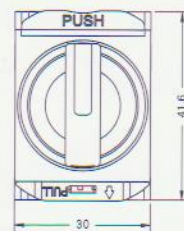
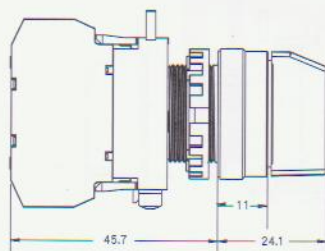

# Ø22 A20 系列控制元件

## 選擇開關 (Selector Switches)

45° -3位置 / 右復歸型標準旋鈕 (45° -3 Position / Knob Type with Spring Return from Right)

A20S



位置數 (No. of Positions)	接點結構 (Contacts)			旋鈕位置 (Operator Position)			型號 (Type No.)	使用電壓記號 (Operating Voltage Code)	顏色記號② (Lens Color Code②)	
	記號 (Configuration)	位置 (Mounting)	類型 (Position)	L	C	R				
45° -3位置 右復歸型標準旋鈕 (45° -3 Position / Knob Type with Spring Return from Right)  L C R ↓	2NO (20)	1	NO	●			A20S-31E20②	無燈泡 (Without Lamp)	blank : 黑色 G : 綠色 R : 紅色 S : 藍色 W : 白色 Y : 黃色	
		2								
		3	NO			●				
	2NO (20N1)	1			●					A20S-31E20N1②
		2	NO			●				
		3	NO			●				
	2NC (02)	1	NC							A20S-31E02②
		2								
		3	NC							
	2NC (02N1)	1								A20S-31E02N1②
		2	NC			●				
		3	NC			●				
	1NO-1NC (11)	1	NO		●					A20S-31E11②
		2								
		3	NC			●				
	1NO-1NC (11N1)	1	NC							A20S-31E11N1②
		2								
		3	NO			●				
	1NO-1NC (11N2)	1	NO		●					A20S-31E11N2②
		2	NC							
3										
1NO-1NC (11N3)	1						A20S-31E11N3②			
	2	NC			●					
	3	NO			●					
1NO-1NC (11N4)	1						A20S-31E11N4②			
	2	NO		●						
	3	NC			●					
3NO (30)	1	NO		●			A20S-31E30②			
	2	NO		●						
	3	NO		●						
3NC (03)	1	NC					A20S-31E03②			
	2	NC								
	3	NC								
2NO-1NC (21)	1	NO		●			A20S-31E21②			
	2	NC			●					
	3	NO			●					
1NO-2NC (12)	1	NC					A20S-31E12②			
	2	NO		●						
	3	NC			●					

■外型尺寸(Dimensions) mm

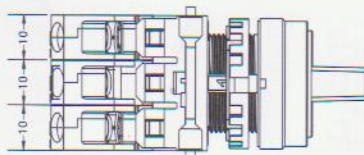

面板厚度 (Panel Thickness)  
0.8~6

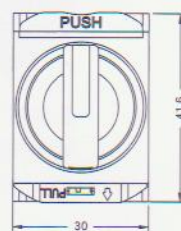
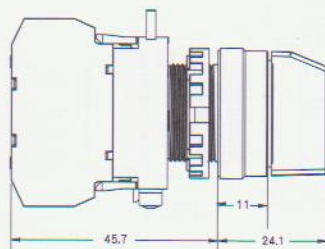

## 選擇開關 (Selector Switches)

45° -3位置 / 左復歸型標準旋鈕 (45° -3 Position / Knob Type with Spring Return from Left)



A20S

位置數 (No. of Positions)	接點結構 (Contacts)			旋鈕位置 (Operator Position)			型號 (Type No.)	使用電壓記號 (Operating Voltage Code)	顏色記號② (Lens Color Code②)	
	記號 (Configuration)	位置 (Mounting)	類型 (Position)	L	C	R				
45° -3位置 左復歸型標準旋鈕 (45° -3 Position / Knob Type with Spring Return from Left)	2NO (20)	1	NO	●			A20S-32E20②	無燈泡 (Without Lamp)	blank : 黑色 G : 綠色 R : 紅色 S : 藍色 W : 白色 Y : 黃色	
		2								
		3	NO			●				
	2NO (20N1)	1			●					A20S-32E20N1②
		2	NO			●				
		3	NO			●				
	2NC (02)	1	NC		■					A20S-32E02②
		2			■					
		3	NC		■					
	2NC (02N1)	1			■					A20S-32E02N1②
		2	NC			●				
		3	NC		■					
	1NO-1NC (11)	1	NO		●					A20S-32E11②
		2			■					
		3	NC		■					
	1NO-1NC (11N1)	1	NC			■				A20S-32E11N1②
		2			■					
		3	NO			●				
1NO-1NC (11N2)	1	NO		●			A20S-32E11N2②			
	2	NC			●					
	3			■						
1NO-1NC (11N3)	1				●		A20S-32E11N3②			
	2	NC			●					
	3	NO			●					
1NO-1NC (11N4)	1			●			A20S-32E11N4②			
	2	NO		●		●				
	3	NC		■						
3NO (30)	1	NO		●			A20S-32E30②			
	2	NO		●		●				
	3	NO		●		●				
3NC (03)	1	NC		■			A20S-32E03②			
	2	NC		■		●				
	3	NC		■		■				
2NO-1NC (21)	1	NO		●			A20S-32E21②			
	2	NC			●					
	3	NO				●				
1NO-2NC (12)	1	NC			■		A20S-32E12②			
	2	NO		●		●				
	3	NC		■		■				

■外型尺寸(Dimensions) mm

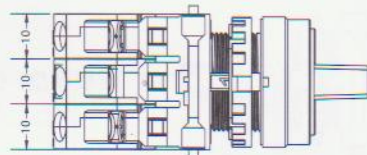

面板厚度 (Panel Thickness)  
0.8~6

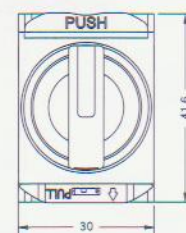
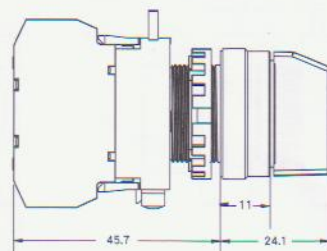

# Ø22 A20 系列控制元件

## 選擇開關 (Selector Switches)

45° -3位置 / 雙向復歸型標準旋鈕 (45° -3 Position / Knob Type with Spring Return from Two-Way)

A20S



位置數 (No. of Positions)	接點結構 (Contacts)			旋鈕位置 (Operator Position)			型號 (Type No.)	使用電壓記號 (Operating Voltage Code)	顏色記號② (Lens Color Code②)	
	記號 (Configuration)	位置 (Mounting)	類型 (Position)	L	C	R				
45° -3位置 雙向復歸型 標準旋鈕 (45° -3 Position / Knob Type with Spring Return from Two-Way)  L C R ↕	2NO (20)	1	NO	●			A20S-33E20②	無燈泡 (Without Lamp)	blank : 黑色 G : 綠色 R : 紅色 S : 藍色 W : 白色 Y : 黃色	
		2								
		3	NO			●				
	2NO (20N1)	1			●					A20S-33E20N1②
		2	NO			●				
		3	NO			●				
	2NC (02)	1	NC		■					A20S-33E02②
		2			■					
		3	NC		■					
	2NC (02N1)	1				●				A20S-33E02N1②
		2	NC		■					
		3	NC		■					
	1NO-1NC (11)	1	NO		●					A20S-33E11②
		2								
		3	NC		■					
	1NO-1NC (11N1)	1								A20S-33E11N1②
		2	NO		●					
		3	NO				●			
1NO-1NC (11N2)	1	NO		●			A20S-33E11N2②			
	2	NC				●				
	3									
1NO-1NC (11N3)	1						A20S-33E11N3②			
	2	NC			●					
	3	NO				●				
1NO-1NC (11N4)	1			●			A20S-33E11N4②			
	2	NO				●				
	3	NC		■						
3NO (30)	1	NO		●			A20S-33E30②			
	2	NO		●		●				
	3	NO		●		●				
3NC (03)	1	NC		■			A20S-33E03②			
	2	NC		■						
	3	NC		■						
2NO-1NC (21)	1	NO		●			A20S-33E21②			
	2	NC			●					
	3	NO				●				
1NO-2NC (12)	1	NC			■		A20S-33E12②			
	2	NO		●		●				
	3	NC		■						

■外型尺寸(Dimensions)mm

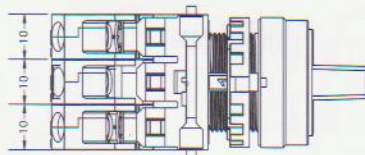

面板厚度 (Panel Thickness)  
0.8~6

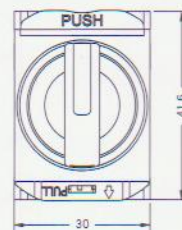
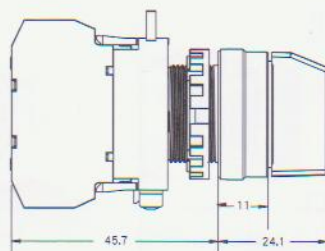



開關構造說明 (Switch Construction Instructions)

A20F

照光選擇開關 (Illuminated Selector Switches)

照光選擇開關  
(Illuminated Selector  
Switches)  
Page.50-55

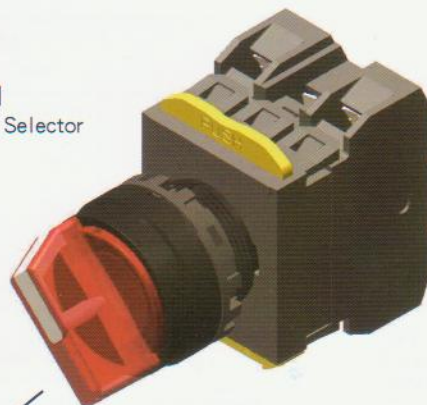

照光選擇開關操作部  
(Illuminated Selector  
Switches Operators)  
Page.70



燈泡  
(Lamp)  
Page.110



開關接點部  
(Contact Block  
Assemblies)  
Page.106-107



接點塊安裝轉接器  
(Contact Block  
Mounting Adapter)  
Page.109



接點塊  
(Contact Block)  
Page.108



全電壓轉接器  
(Full Voltage  
Adapter)  
Page.109



接點塊  
(Contact Block)  
Page.108



# Ø22 A20 系列控制元件

## 照光選擇開關 (Illuminated Selector Switches)

90° -2位置 / 交替型標準旋鈕 (90° -2 Position / Knob Type with Maintained)

A20F



位置數 (No. of Positions)	接點結構 (Contacts)			旋鈕位置 (Operator Position)			型號 (Type No.)	使用電壓記號③ (Operating Voltage Code③)	顏色記號② (Lens Color Code②)
	記號 (Configuration)	位置 (Mounting)	類型 (Position)	L	R	---			
90° -2位置 / 交替型標準 旋鈕 (90° -2 Position / Knob Type with Maintained)	1NO (10)	1	NO		●		A20F-2E10Q③②	0 (無燈泡) (Without Lamp) 最大(max.) 250V AC/DC	A : 琥珀色 G : 綠色 R : 紅色 S : 藍色 W : 乳白色 Y : 黃色  A : amber G : green R : red S : blue W : white Y : yellow
		2	Lamp						
		3							
	1NC (01)	1			●		A20F-2E01Q③②	內置LED : LAED-③② (Built-in LED lamp) 2 (6V AC/DC) 3 (12V AC/DC) 4 (24V AC/DC) H (110V AC/DC) M3 (230/240V AC/ DC)	
		2	Lamp						
		3	NC						
	2NO (20)	1	NO		●		A20F-2E20Q③②	內置白熾燈泡 : LA-T③ (Built-in incandescent lamp)	
		2	Lamp						
		3	NO		●				
	2NC (02)	1	NC		●		A20F-2E02Q③②	內置白熾燈泡 : LA-T③ (Built-in incandescent lamp)	
		2	Lamp						
		3	NC	●					
1NO-1NC (11)	1	NO		●		A20F-2E11Q③②	5 (6V AC/DC) 6 (12V AC/DC) 7 (24V AC/DC)		
	2	Lamp							
	3	NC	●						

### ■外型尺寸(Dimensions) mm

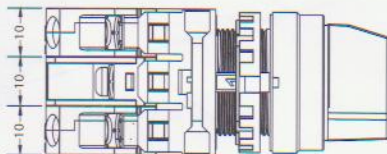

面板厚度 (Panel Thickness)  
0.8~6

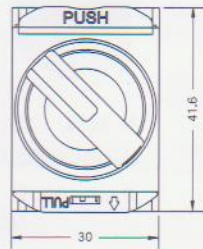
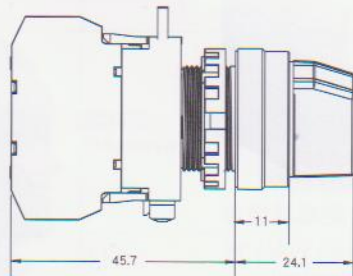

## 照光選擇開關 (Illuminated Selector Switches)

90° -2位置 / 右復歸型標準旋鈕 (90° -2 Position / Knob Type with Spring Return from Right)



A20F

位置數 (No. of Positions)	接點結構 (Contacts)			旋鈕位置 (Operator Position)			型號 (Type No.)	使用電壓記號③ (Operating Voltage Code③)	顏色記號② (Lens Color Code②)
	記號 (Configuration)	位置 (Mounting)	類型 (Position)	L	R	---			
90° -2位置 / 右復歸型標準旋鈕 (90° -2 Position / Knob Type with Spring Return from Right)	1NO (10)	1	NO		●		A20F-21E10Q③②	0 (無燈泡) (Without Lamp) 最大(max.) 250V AC/DC	A : 琥珀色 G : 綠色 R : 紅色 S : 藍色 W : 乳白色 Y : 黃色  A : amber G : green R : red S : blue W : white Y : yellow
		2	Lamp						
		3							
	1NC (01)	1			●		A20F-21E01Q③②	內置LED : LAED-③② (Built-in LED lamp) 2 (6V AC/DC) 3 (12V AC/DC) 4 (24V AC/DC) H (110V AC/DC) M3 (230/240V AC/DC)	
		2	Lamp						
		3	NC	●					
	2NO (20)	1	NO		●		A20F-21E20Q③②		
		2	Lamp						
		3	NO		●				
	2NC (02)	1	NC		●		A20F-21E02Q③②	內置白熾燈泡 : LA-T③ (Built-in incandescent lamp)	
		2	Lamp						
		3	NC	●					
1NO-1NC (11)	1	NO		●	●	A20F-21E11Q③②	5 (6V AC/DC) 6 (12V AC/DC) 7 (24V AC/DC)		
	2	Lamp							
	3	NC	●						

### ■外型尺寸(Dimensions) mm

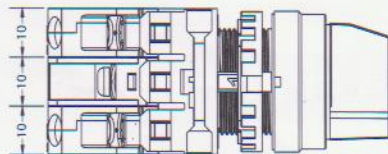

面板厚度 (Panel Thickness)  
0.8~6

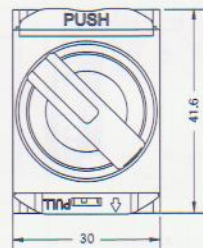
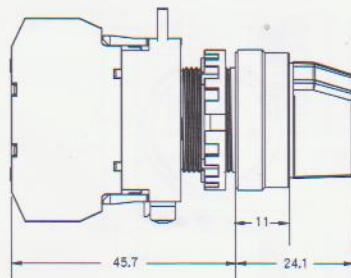

# Ø22 A20 系列控制元件

## 照光選擇開關 (Illuminated Selector Switches)

45° -3位置 / 交替型標準旋鈕 (45° -3 Position / Knob Type with Maintained)

A20F



位置數 (No. of Positions)	接點結構 (Contacts)			旋鈕位置 (Operator Position)			型號 (Type No.)	使用電壓記號③ (Operating Voltage Code③)	顏色記號② (Lens Color Code②)
	記號 (Configuration)	位置 (Mounting)	類型 (Position)	L	C	R			
45° -3位置 / 交替型標準 旋鈕 (45° -3 Position / Knob Type with Maintained)  L C R ↓	2NO (20)	1	NO	●			A20F-3E20Q③②	0 (無燈泡) (Without Lamp) 最大(max.) 250V AC/DC	A : 琥珀色 G : 綠色 R : 紅色 S : 藍色 W : 乳白色 Y : 黃色  A : amber G : green R : red S : blue W : white Y : yellow
		2	Lamp						
		3	NO			●			
	2NC (02)	1	NC		■		A20F-3E02Q③②	內置LED : LAED-③② (Built-in LED lamp) 2 (6V AC/DC) 3 (12V AC/DC) 4 (24V AC/DC) H (110V AC/DC) M3 (230/240V AC/ DC)	
		2	Lamp						
		3	NC		■				
	1NO-1NC (11)	1	NO	●			A20F-3E11Q③②	內置白熾燈泡 : LA-T③ (Built-in incandescent lamp)	
		2	Lamp						
		3	NC		■				
	1NO-1NC (11N1)	1	NC			■	A20F-3E11N1Q③②	5 (6V AC/DC) 6 (12V AC/DC) 7 (24V AC/DC)	
		2	Lamp						
		3	NO			●			

■外型尺寸(Dimensions) mm

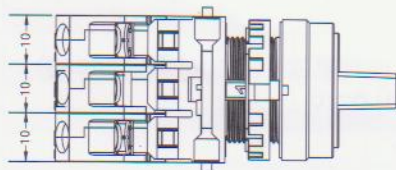

面板厚度 (Panel Thickness)  
0.8~6

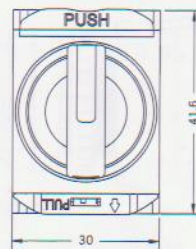
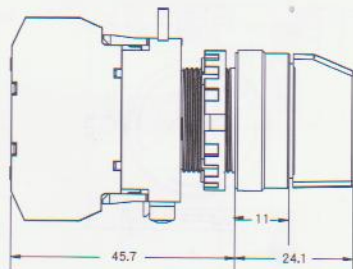

# Ø22 A20 系列控制元件

## 照光選擇開關 (Illuminated Selector Switches)

45° -3位置 / 右復歸型標準旋鈕 (45° -3 Position / Knob Type with Spring Return from Right)



A20F

位置數 (No. of Positions)	接點結構 (Contacts)			旋鈕位置 (Operator Position)			型號 (Type No.)	使用電壓記號③ (Operating Voltage Code③)	顏色記號② (Lens Color Code②)
	記號 (Configuration)	位置 (Mounting)	類型 (Position)	L	C	R			
45° -3位置 右復歸型標準旋鈕 (45° -3 Position / Knob Type with Spring Return from Right)	2NO (20)	1	NO	●			A20F-31E20Q③②	0 (無燈泡) (Without Lamp) 最大(max.) 250V AC/DC	A : 琥珀色 G : 綠色 R : 紅色 S : 藍色 W : 乳白色 Y : 黃色  A : amber G : green R : red S : blue W : white Y : yellow
		2	Lamp						
		3	NO			●			
	2NC (02)	1	NC		■		A20F-31E02Q③②	內置LED : LAED-③② (Built-in LED lamp) 2 (6V AC/DC) 3 (12V AC/DC) 4 (24V AC/DC) H (110V AC/DC) M3 (230/240V AC/DC)	
		2	Lamp						
		3	NC		■				
	1NO-1NC (11)	1	NO	●			A20F-31E11Q③②	內置白熾燈泡 : LA-T③ (Built-in incandescent lamp)	
		2	Lamp						
		3	NC		■				
	1NO-1NC (11N1)	1	NC			■	A20F-31E11N1Q③②	5 (6V AC/DC) 6 (12V AC/DC) 7 (24V AC/DC)	
		2	Lamp						
		3	NO			●			

■外型尺寸(Dimensions) mm

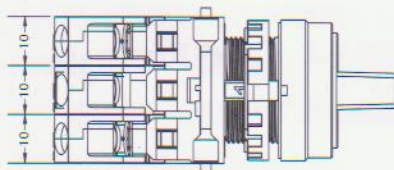

面板厚度 (Panel Thickness)  
0.8~6

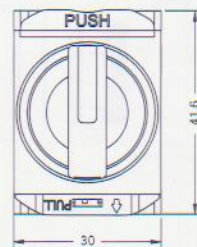
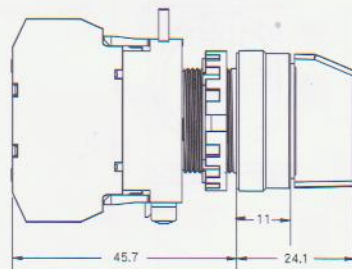

# Ø22 A20 系列控制元件

## 照光選擇開關 (Illuminated Selector Switches)

45° -3位置 / 左復歸型標準旋鈕 (45° -3 Position / Knob Type with Spring Return from Left)

A20F



位置數 (No. of Positions)	接點結構 (Contacts)			旋鈕位置 (Operator Position)			型號 (Type No.)	使用電壓記號③ (Operating Voltage Code③)	顏色記號② (Lens Color Code②)
	記號 (Configuration)	位置 (Mounting)	類型 (Position)	L	C	R			
45° -3位置 / 左復歸型標準旋鈕 (45° -3 Position / Knob Type with Spring Return from Left)	2NO (20)	1	NO	●			A20F-32E20Q③②	0 (無燈泡) (Without Lamp) 最大(max.) 250V AC/DC	A : 琥珀色 G : 綠色 R : 紅色 S : 藍色 W : 乳白色 Y : 黃色  A : amber G : green R : red S : blue W : white Y : yellow
		2	Lamp						
		3	NO			●			
	2NC (02)	1	NC		■		A20F-32E02Q③②	內置LED : LAED-③② (Built-in LED lamp) 2 (6V AC/DC) 3 (12V AC/DC) 4 (24V AC/DC) H (110V AC/DC) M3 (230/240V AC/DC)	
		2	Lamp						
		3	NC		■				
	1NO-1NC (11)	1	NO	●			A20F-32E11Q③②	內置白熾燈泡 : LA-T③ (Built-in incandescent lamp)	
		2	Lamp						
		3	NC		■				
	1NO-1NC (11N1)	1	NC			■	A20F-32E11N1Q③②	5 (6V AC/DC) 6 (12V AC/DC) 7 (24V AC/DC)	
		2	Lamp						
		3	NO			●			

### ■外型尺寸(Dimensions) mm

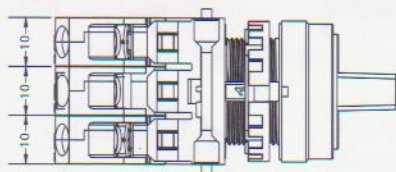

面板厚度 (Panel Thickness)  
0.8~6

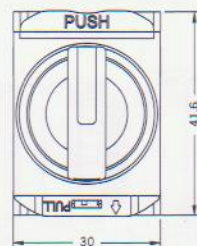
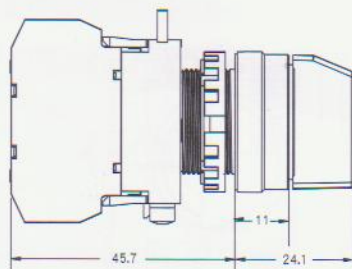

# Ø22 A20 系列控制元件

## 照光選擇開關 (Illuminated Selector Switches)

45° -3位置 / 雙向復歸型標準旋鈕 (45° -3 Position / Knob Type with Spring Return from Two-Way)



A20F

位置數 (No. of Positions)	接點結構 (Contacts)			旋鈕位置 (Operator Position)			型號 (Type No.)	使用電壓記號③ (Operating Voltage Code③)	顏色記號② (Lens Color Code②)
	記號 (Configuration)	位置 (Mounting)	類型 (Position)	L	C	R			
45° -3位置 雙向復歸型 標準旋鈕 (45° -3 Position / Knob Type with Spring Return from Two-Way)	2NO (20)	1	NO	●			A20F-33E20Q③②	0 (無燈泡) (Without Lamp) 最大(max.) 250V AC/DC	A : 琥珀色 G : 綠色 R : 紅色 S : 藍色 W : 乳白色 Y : 黃色
		2	Lamp						
		3	NO			●			
	2NC (02)	1	NC		●		A20F-33E02Q③②	內置LED : LAED-③② (Built-in LED lamp) 2 (6V AC/DC) 3 (12V AC/DC) 4 (24V AC/DC) H (110V AC/DC) M3 (230/240V AC/ DC)	
		2	Lamp						
		3	NC		●				
1NO-1NC (11)	L C R ↕	1	NO	●			A20F-33E11Q③②	內置白熾燈泡 : LA-T③ (Built-in incandescent lamp)	
		2	Lamp						
		3	NC		●				
1NO-1NC (11N1)	L C R ↕	1	NC		●		A20F-33E11N1Q③②	5 (6V AC/DC) 6 (12V AC/DC) 7 (24V AC/DC)	
		2	Lamp						
		3	NO			●			

### ■外型尺寸(Dimensions) mm

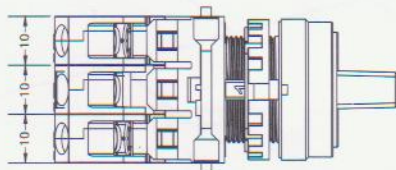

面板厚度 (Panel Thickness)  
0.8~6

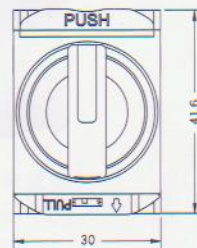
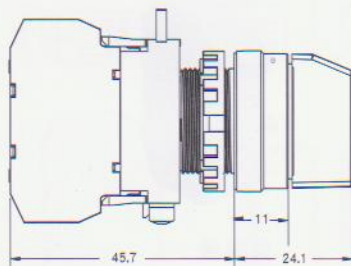

開關構造說明 (Switch Construction Instructions)

鑰匙選擇開關 (Key Selector Switches)

A20K

鑰匙選擇開關  
(Key Selector Switches)  
Page.57-62

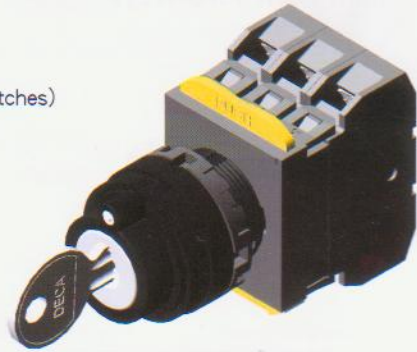

鑰匙選擇開關操作部  
(Key Selector Switches  
Operators)  
Page.71



開關接點部  
(Contact Block  
Assemblies)  
Page.106-107



接點塊安裝轉接器  
(Contact Block  
Mounting Adapter)  
Page.109



接點塊  
(Contact Block)  
Page.108



接點塊  
(Contact Block)  
Page.108



接點塊  
(Contact Block)  
Page.108





# Ø22 A20 系列控制元件

## 鑰匙選擇開關 (Key Selector Switches)

90° -2位置 / 交替型 (90° -2 Position / Maintained)

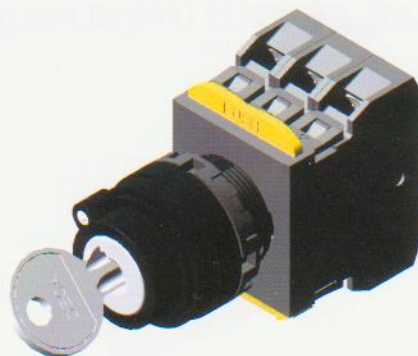

A20K

位置數 (No. of Positions)	接點結構 (Contacts)			旋鈕位置 (Operator Position)			型號 (Type No.)	使用電壓記號 (Operating Voltage Code)	顏色記號 (Lens Color Code)
	記號 (Configuration)	位置 (Mounting)	類型 (Position)	L	R	---			
90° -2位置 / 交替型鈕 (90° -2 Position / Maintained)	1NO (10)	1	NO		●		A20K-2E10	無燈泡 (Without Lamp)	僅黑色 (Black only)
		2							
		3							
	1NC (01)	1			●		A20K-2E01		
		2							
		3	NC	●					
	2NO (20)	1	NO		●		A20K-2E20		
		2							
		3	NO		●				
	2NC (02)	1	NC		●		A20K-2E02		
		2							
		3	NC	●					
1NO-1NC (11)	1	NO		●		A20K-2E11			
	2								
	3	NC	●						
3NO (30)	1	NO		●		A20K-2E30			
	2	NO		●					
	3	NO		●					
3NC (03)	1	NC	●			A20K-2E03			
	2	NC	●						
	3	NC	●						
2NO-1NC (21)	1	NO		●		A20K-2E21			
	2	NO		●					
	3	NC	●						
1NO-2NC (12)	1	NO		●		A20K-2E12			
	2	NC	●						
	3	NC	●						

### ■外型尺寸(Dimensions) mm

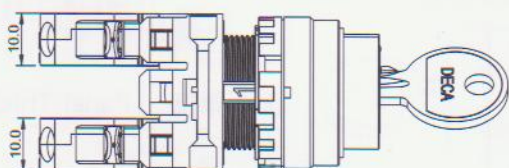

面板厚度 (Panel Thickness)  
0.8~6

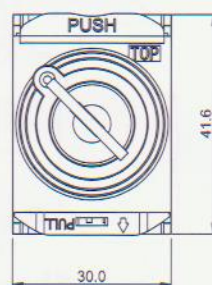
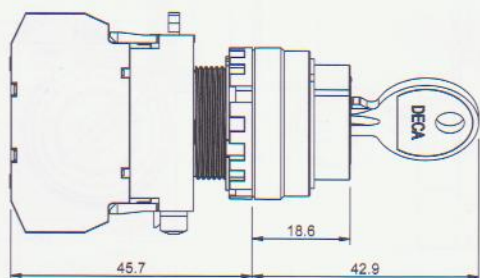

## 鑰匙選擇開關 (Key Selector Switches)

90° -2位置 / 右復歸型 (90° -2 Position / Spring Return from Right)

A20K



位置數 (No. of Positions)	接點結構 (Contacts)			旋鈕位置 (Operator Position)			型號 (Type No.)	使用電壓記號 (Operating Voltage Code)	顏色記號 (Lens Color Code)	
	記號 (Configuration)	位置 (Mounting)	類型 (Position)	L	R	---				
90° -2位置 / 右復歸型 (90° -2 Position / Spring Return from Right)	1NO (10)	1	NO		●		A20K-21E10	無燈泡 (Without Lamp)	僅黑色 (Black only)	
		2								
		3								
	1NC (01)	1								A20K-21E01
		2								
		3	NC	●						
	2NO (20)	1	NO			●				A20K-21E20
		2								
		3	NO			●				
	2NC (02)	1	NC			●				A20K-21E02
		2								
		3	NC	●						
1NO-1NC (11)	1	NO			●		A20K-21E11			
	2									
	3	NC	●							
3NO (30)	1	NO			●		A20K-21E30			
	2	NO			●					
	3	NO			●					
3NC (03)	1	NC	●				A20K-21E03			
	2	NC	●							
	3	NC	●							
2NO-1NC (21)	1	NO			●		A20K-21E21			
	2	NO			●					
	3	NC	●							
1NO-2NC (12)	1	NO			●		A20K-21E12			
	2	NC	●							
	3	NC	●							

### ■ 外型尺寸 (Dimensions) mm

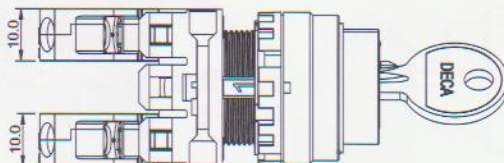

面板厚度 (Panel Thickness)  
0.8~6

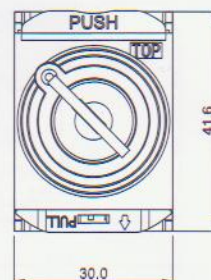
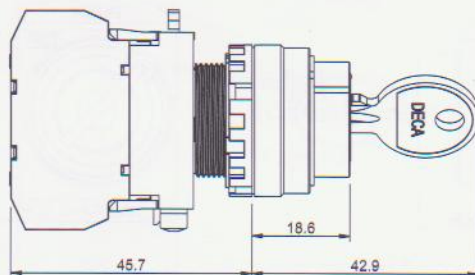

# Ø22 A20 系列控制元件

## 鑰匙選擇開關 (Key Selector Switches)

45° -3位置 / 交替型 (45° -3 Position / Maintained)

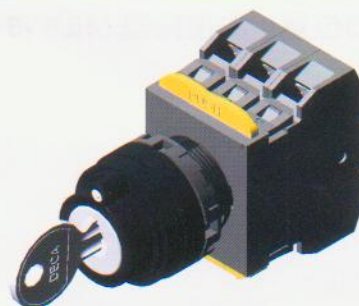

A20K

位置數 (No. of Positions)	接點結構 (Contacts)			旋鈕位置 (Operator Position)			型號 (Type No.)	使用電壓記號 (Operating Voltage Code)	顏色記號 (Lens Color Code)	
	記號 (Configuration)	位置 (Mounting)	類型 (Position)	L	C	R				
45° -3位置 / 交替型 (45° -3 Position / Maintained)	2NO (20)	1	NO	●			A20K-3E20	無燈泡 (Without Lamp)	僅黑色 (Black only)	
		2								
		3	NO			●				
	2NO (20N1)	1			●		●			A20K-3E20N1
		2	NO		●		●			
		3	NO				●			
	2NC (02)	1	NC		■					A20K-3E02
		2			■					
		3	NC		■					
	2NC (02N1)	1				●				A20K-3E02N1
		2	NC		■					
		3	NC		■					
	1NO-1NC (11)	1	NO		●					A20K-3E11
		2								
		3	NC		■					
	1NO-1NC (11N1)	1				■				A20K-3E11N1
		2								
		3	NO				●			
1NO-1NC (11N2)	1	NO		●			A20K-3E11N2			
	2	NC				●				
	3									
1NO-1NC (11N3)	1				●		A20K-3E11N3			
	2	NC				●				
	3	NO				●				
1NO-1NC (11N4)	1			●		●	A20K-3E11N4			
	2	NO		●		●				
	3	NC		■						
3NO (30)	1	NO		●		●	A20K-3E30			
	2	NO		●		●				
	3	NO		●		●				
3NC (03)	1	NC			■		A20K-3E03			
	2	NC			■					
	3	NC		■						
2NO-1NC (21)	1	NO		●			A20K-3E21			
	2	NC			●					
	3	NO				●				
1NO-2NC (21)	1	NC			■		A20K-3E12			
	2	NO		●		●				
	3	NC		■						

L C R  
↓

■外型尺寸(Dimensions) mm

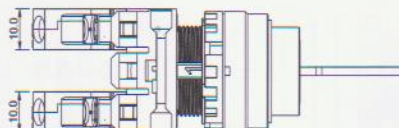

面板厚度 (Panel Thickness)  
0.8~6

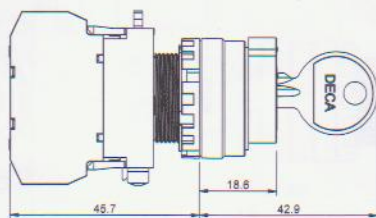

# Ø22 A20 系列控制元件

## 鑰匙選擇開關 (Key Selector Switches)

45° -3位置 / 右復歸型 (45° -3 Position / Spring Return from Right)

A20K

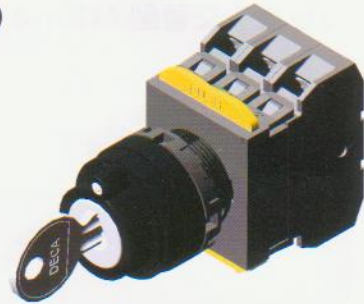

位置數 (No. of Positions)	接點結構 (Contacts)			旋鈕位置 (Operator Position)			型號 (Type No.)	使用電壓記號 (Operating Voltage Code)	顏色記號 (Lens Color Code)	
	記號 (Configuration)	位置 (Mounting)	類型 (Position)	L	C	R				
45° -3位置 / 右復歸型 (45° -3 Position / Spring Return from Right)	2NO (20)	1	NO	●			A20K-31E20	無燈泡 (Without Lamp)	僅黑色 (Black only)	
		2								
		3	NO			●				
	2NO (20N1)	1								A20K-31E20N1
		2	NO	●		●				
		3	NO			●				
	2NC (02)	1	NC		■					A20K-31E02
		2			■					
		3	NC		■					
	2NC (02N1)	1				●				A20K-31E02N1
		2	NC		■					
		3	NC		■					
	1NO-1NC (11)	1	NO	●						A20K-31E11
		2			■					
		3	NC		■					
	1NO-1NC (11N1)	1	NC			■				A20K-31E11N1
		2			■					
		3	NO				●			
1NO-1NC (11N2)	1	NO	●				A20K-31E11N2			
	2	NC				●				
	3					●				
1NO-1NC (11N3)	1				●		A20K-31E11N3			
	2	NC		■						
	3	NO				●				
1NO-1NC (11N4)	1						A20K-31E11N4			
	2	NO	●			●				
	3	NC		■						
3NO (30)	1	NO	●				A20K-31E30			
	2	NO	●			●				
	3	NO				●				
3NC (03)	1	NC		■			A20K-31E03			
	2	NC		■						
	3	NC		■						
2NO-1NC (21)	1	NO	●				A20K-31E21			
	2	NC		■						
	3	NO				●				
1NO-2NC (12)	1	NC		■			A20K-31E12			
	2	NO	●			●				
	3	NC		■						

### ■ 外型尺寸 (Dimensions) mm

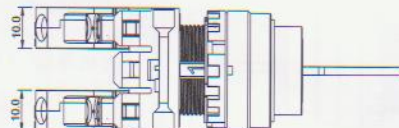

面板厚度 (Panel Thickness)  
0.8~6

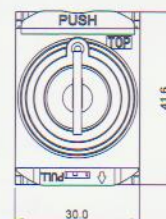
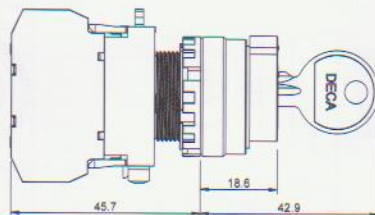

# Ø22 A20 系列控制元件

## 鑰匙選擇開關 (Key Selector Switches)

45° -3位置 / 左復歸型 (45° -3 Position / Spring Return from Left)



A20K

位置數 (No. of Positions)	接點結構 (Contacts)			旋鈕位置 (Operator Position)			型號 (Type No.)	使用電壓記號 (Operating Voltage Code)	顏色記號 (Lens Color Code)	
	記號 (Configuration)	位置 (Mounting)	類型 (Position)	L	C	R				
45° -3位置 / 左復歸型 (45° -3 Position / Spring Return from Left)	2NO (20)	1	NO	●			A20K-32E20	無燈泡 (Without Lamp)	僅黑色 (Black only)	
		2								
		3	NO			●				
	2NO (20N1)	1								A20K-32E20N1
		2	NO	●		●				
		3	NO			●				
	2NC (02)	1								A20K-32E02
		2	NC		■					
		3	NC		■					
	2NC (02N1)	1								A20K-32E02N1
		2	NC		●					
		3	NC		■					
	1NO-1NC (11)	1			●					A20K-32E11
		2								
		3	NC		■					
	1NO-1NC (11N1)	1								A20K-32E11N1
		2	NC		■					
		3	NO			●				
1NO-1NC (11N2)	1			●			A20K-32E11N2			
	2	NC				●				
	3									
1NO-1NC (11N3)	1						A20K-32E11N3			
	2	NC		●						
	3	NO			●					
1NO-1NC (11N4)	1			●			A20K-32E11N4			
	2	NO		●		●				
	3	NC		■						
3NO (30)	1			●			A20K-32E30			
	2	NO		●		●				
	3	NO				●				
3NC (03)	1						A20K-32E03			
	2	NC			●					
	3	NC		■						
2NO-1NC (21)	1			●			A20K-32E21			
	2	NC			●					
	3	NO				●				
1NO-2NC (12)	1						A20K-32E12			
	2	NO		●		●				
	3	NC		■						

■外型尺寸(Dimensions) mm

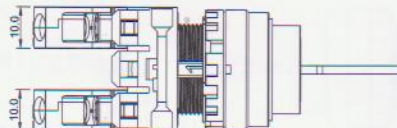

面板厚度 (Panel Thickness)  
0.8~6

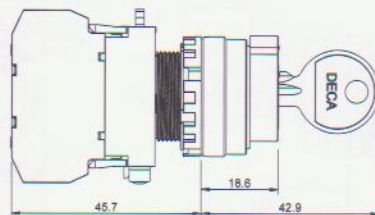

## 鑰匙選擇開關 (Key Selector Switches)

45° -3位置 / 雙向復歸型 (45° -3 Position / Spring Return from Two-Way)

A20K



位置數 (No. of Positions)	接點結構 (Contacts)			旋鈕位置 (Operator Position)			型號 (Type No.)	使用電壓記號 (Operating Voltage Code)	顏色記號 (Lens Color Code)	
	記號 (Configuration)	位置 (Mounting)	類型 (Position)	L	C	R				
45° -3位置 / 雙向復歸型 (45° -3 Position / Spring Return from Two-Way)  L C R ↕	2NO (20)	1	NO	●			A20K-33E20	無燈泡 (Without Lamp)	僅黑色 (Black only)	
		2								
		3	NO			●				
	2NO (20N1)	1								A20K-33E20N1
		2	NO	●						
		3	NO			●				
	2NC (02)	1	NC							A20K-33E02
		2								
		3	NC							
	2NC (02N1)	1								A20K-33E02N1
		2	NC		●					
		3	NC			●				
	1NO-1NC (11)	1	NO	●						A20K-33E11
		2								
		3	NC							
	1NO-1NC (11N1)	1	NC							A20K-33E11N1
		2								
		3	NO			●				
1NO-1NC (11N2)	1	NO	●				A20K-33E11N2			
	2	NC								
	3				●					
1NO-1NC (11N3)	1						A20K-33E11N3			
	2	NC		●						
	3	NO			●					
1NO-1NC (11N4)	1						A20K-33E11N4			
	2	NO	●							
	3	NC			●					
3NO (30)	1	NO	●				A20K-33E30			
	2	NO	●							
	3	NO			●					
3NC (03)	1	NC					A20K-33E03			
	2	NC		●						
	3	NC			●					
2NO-1NC (21)	1	NO	●				A20K-33E21			
	2	NC			●					
	3	NO			●					
1NO-2NC (12)	1	NC					A20K-33E12			
	2	NO	●							
	3	NC			●					

■外型尺寸(Dimensions) mm

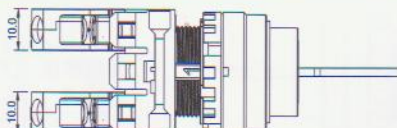

面板厚度 (Panel Thickness)  
0.8~6

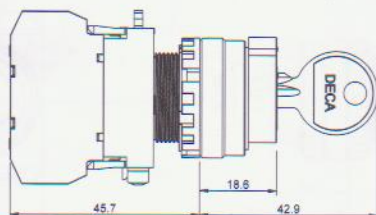

緊急停止開關操作部 (Emergency Stop Switches Operators)

操作部





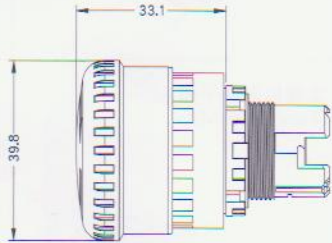

名稱 / 外觀 (Style)	動作類型 (Operation)	型號 (Type No.)	顏色 (Lens Color)	頭部尺寸 (Dimensions) Unit : mm
<p>φ 40mm 蘑菇頭形 (Mushroom φ 40mm)</p> 	<p>按鎖定拉出或旋轉復歸 (Pushlock Pull/Turn Reset)</p>	A20B-V4ER	僅紅色 (Red only)	

照光緊急停止開關操作部 (Illuminated Emergency Stop Switches Operators)

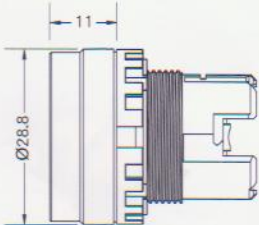
名稱 / 外觀 (Style)	動作類型 (Operation)	型號 (Type No.)	顏色 (Lens Color)	頭部尺寸 (Dimensions) Unit : mm
<p>φ 40mm 蘑菇頭形 (Mushroom φ 40mm)</p> 	<p>按鎖定拉出或旋轉復歸 (Pushlock Pull/Turn Reset)</p>	A20L-V4ER	僅紅色 (Red only)	

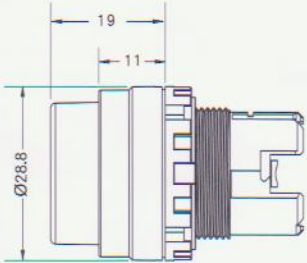
## 按鈕開關操作部 (Pushbutton Operators)

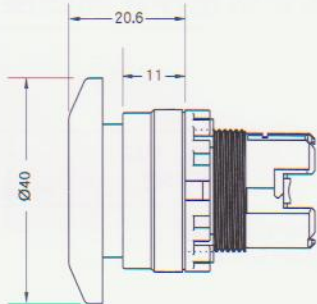
操作部

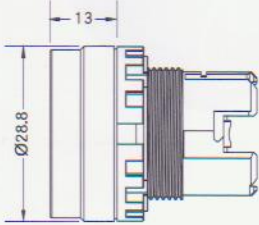
名稱 / 外觀 (Style)	動作類型 (Operation)	型號 (Type No.)	顏色 (Lens Color)	頭部尺寸 (Dimensions) Unit : mm			
平頭形 (Flush)  	瞬時型 (Momentary)	A20B-M1EB	黑色 (black)				
		A20B-M1EG	綠色 (green)				
		A20B-M1ER	紅色 (red)				
		A20B-M1ES	藍色 (blue)				
		A20B-M1EW	白色 (white)				
		A20B-M1EY	黃色 (yellow)				
	交替型 (Maintained)	A20B-A1EB	黑色 (black)				
		A20B-A1EG	綠色 (green)				
		A20B-A1ER	紅色 (red)				
		A20B-A1ES	藍色 (blue)				
		A20B-A1EW	白色 (white)				
		A20B-A1EY	黃色 (yellow)				
		凸頭形 (Extended)  	瞬時型 (Momentary)		A20B-M2EB	黑色 (black)	
					A20B-M2EG	綠色 (green)	
A20B-M2ER	紅色 (red)						
A20B-M2ES	藍色 (blue)						
A20B-M2EW	白色 (white)						
A20B-M2EY	黃色 (yellow)						
交替型 (Maintained)	A20B-A2EB		黑色 (black)				
	A20B-A2EG		綠色 (green)				
	A20B-A2ER		紅色 (red)				
	A20B-A2ES		藍色 (blue)				
	A20B-A2EW		白色 (white)				
	A20B-A2EY		黃色 (yellow)				
	φ 40mm 蘑菇頭形 (Mushroom φ 40mm)  		瞬時型 (Momentary)	A20B-M4EB	黑色 (black)		
				A20B-M4EG	綠色 (green)		
A20B-M4ER		紅色 (red)					
A20B-M4ES		藍色 (blue)					
A20B-M4EW		白色 (white)					
A20B-M4EY		黃色 (yellow)					
交替型 (Maintained)		A20B-A4EB	黑色 (black)				
		A20B-A4EG	綠色 (green)				
		A20B-A4ER	紅色 (red)				
		A20B-A4ES	藍色 (blue)				
		A20B-A4EW	白色 (white)				
		A20B-A4EY	黃色 (yellow)				
		金屬框圓形平頭 (Flush with Metal Bezel)  	瞬時型 (Momentary)	A20B-MS1EB	黑色 (black)		
				A20B-MS1EG	綠色 (green)		
A20B-MS1ER	紅色 (red)						
A20B-MS1ES	藍色 (blue)						
A20B-MS1EW	白色 (white)						
A20B-MS1EY	黃色 (yellow)						
交替型 (Maintained)	A20B-AS1EB		黑色 (black)				
	A20B-AS1EG		綠色 (green)				
	A20B-AS1ER		紅色 (red)				
	A20B-AS1ES		藍色 (blue)				
	A20B-AS1EW		白色 (white)				
	A20B-AS1EY		黃色 (yellow)				









## 按鈕開關操作部 (Pushbutton Operators)

操作部

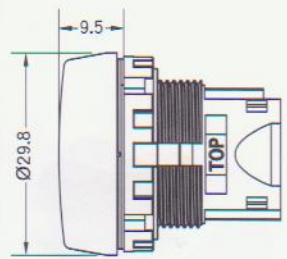
名稱 / 外觀 (Style)	動作類型 (Operation)	型號 (Type No.)	顏色 (Lens Color)	頭部尺寸 (Dimensions) Unit : mm
金屬鑲嵌框圓形平頭 (Flush with Metal Silhouette)  	瞬時型 (Momentary)	A20B-MU1EB	黑色 (black)	
		A20B-MU1EG	綠色 (green)	
		A20B-MU1ER	紅色 (red)	
		A20B-MU1ES	藍色 (blue)	
		A20B-MU1EW	白色 (white)	
		A20B-MU1EY	黃色 (yellow)	
	交替型 (Maintained)	A20B-AU1EB	黑色 (black)	
		A20B-AU1EG	綠色 (green)	
		A20B-AU1ER	紅色 (red)	
		A20B-AU1ES	藍色 (blue)	
		A20B-AU1EW	白色 (white)	
		A20B-AU1EY	黃色 (yellow)	

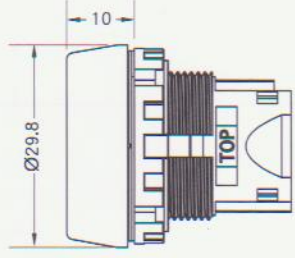

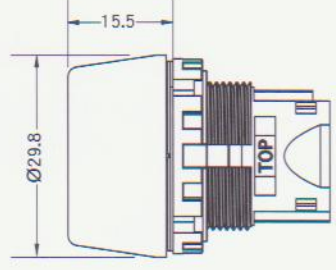

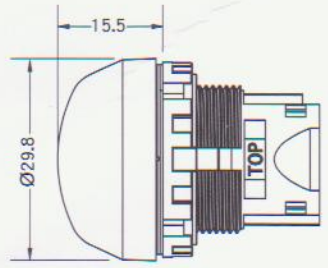

## 指示燈操作部 (Pilot Lights Operators)

操作部

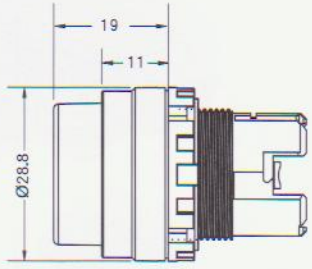
名稱 / 外觀 (Style)	型號 (Type No.)	顏色 (Lens Color)	頭部尺寸 (Dimensions) Unit : mm
平頭形 (Flush) 	A20P-1EA	琥珀色 (amber)	
	A20P-1EC	透明 (clear)	
	A20P-1EG	綠色 (green)	
	A20P-1EPW	純白色 (pure white)	
	A20P-1ER	紅色 (red)	
	A20P-1ES	藍色 (blue)	
	A20P-1EW	乳白色 (white)	
	A20P-1EY	黃色 (yellow)	
平頭形(記名式) (Flush Marking Type) 	A20P-1BEA	琥珀色 (amber)	
	A20P-1BEC	透明 (clear)	
	A20P-1BEG	綠色 (green)	
	A20P-1BEPW	純白色 (pure white)	
	A20P-1BER	紅色 (red)	
	A20P-1BES	藍色 (blue)	
	A20P-1BEW	乳白色 (white)	
	A20P-1BEY	黃色 (yellow)	
凸頭形 (Extended) 	A20P-2TEA	琥珀色 (amber)	
	A20P-2TEC	透明 (clear)	
	A20P-2TEG	綠色 (green)	
	A20P-2TEPW	純白色 (pure white)	
	A20P-2TER	紅色 (red)	
	A20P-2TES	藍色 (blue)	
	A20P-2TEW	乳白色 (white)	
	A20P-2TEY	黃色 (yellow)	
半球形 (Dome) 	A20P-2EA	琥珀色 (amber)	
	A20P-2EC	透明 (clear)	
	A20P-2EG	綠色 (green)	
	A20P-2EPW	純白色 (pure white)	
	A20P-2ER	紅色 (red)	
	A20P-2ES	藍色 (blue)	
	A20P-2EW	乳白色 (white)	
	A20P-2EY	黃色 (yellow)	

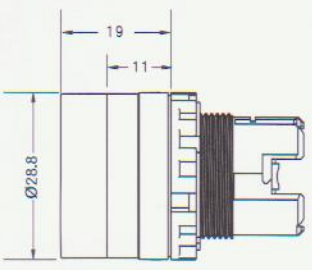
## 照光按鈕開關操作部 (Illuminated Pushbutton Operators)

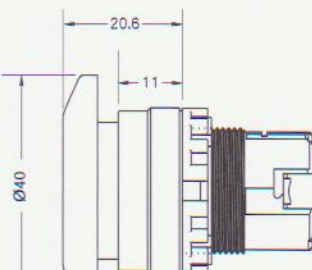
操作部

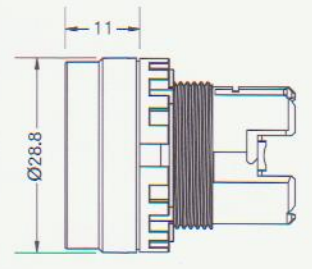

名稱 / 外觀 (Style)	動作類型 (Operation)	型號 (Type No.)	顏色 (Lens Color)	頭部尺寸 (Dimensions) Unit: mm
<b>圓形凸頭 (Extended)</b> 	<b>瞬時型 (Momentary)</b>	A20L-M2EA	琥珀色 (amber)	
		A20L-M2EC	透明 (clear)	
		A20L-M2EG	綠色 (green)	
		A20L-M2EPW	純白色 (pure white)	
		A20L-M2ER	紅色 (red)	
		A20L-M2ES	藍色 (blue)	
		A20L-M2EW	乳白色 (white)	
	<b>交替型 (Maintained)</b>	A20L-A2EA	琥珀色 (amber)	
		A20L-A2EC	透明 (clear)	
		A20L-A2EG	綠色 (green)	
		A20L-A2EPW	純白色 (pure white)	
		A20L-A2ER	紅色 (red)	
		A20L-A2ES	藍色 (blue)	
		A20L-A2EW	乳白色 (white)	
<b>全護圈圓形凸頭 (Extended with Full Shroud)</b> 	<b>瞬時型 (Momentary)</b>	A20L-MF2EA	琥珀色 (amber)	
		A20L-MF2EC	透明 (clear)	
		A20L-MF2EG	綠色 (green)	
		A20L-MF2EPW	純白色 (pure white)	
		A20L-MF2ER	紅色 (red)	
		A20L-MF2ES	藍色 (blue)	
		A20L-MF2EW	乳白色 (white)	
	<b>交替型 (Maintained)</b>	A20L-MF2EY	黃色 (yellow)	
		A20L-AF2EA	琥珀色 (amber)	
		A20L-AF2EC	透明 (clear)	
		A20L-AF2EG	綠色 (green)	
		A20L-AF2EPW	純白色 (pure white)	
		A20L-AF2ER	紅色 (red)	
		A20L-AF2ES	藍色 (blue)	
<b>φ 40mm 蘑菇頭形 (Mushroom φ 40mm)</b> 	<b>瞬時型 (Momentary)</b>	A20L-M4EA	琥珀色 (amber)	
		A20L-M4EC	透明 (clear)	
		A20L-M4EG	綠色 (green)	
		A20L-M4EPW	純白色 (pure white)	
		A20L-M4ER	紅色 (red)	
		A20L-M4ES	藍色 (blue)	
		A20L-M4EW	乳白色 (white)	
	<b>交替型 (Maintained)</b>	A20L-M4EY	黃色 (yellow)	
		A20L-A4EA	琥珀色 (amber)	
		A20L-A4EC	透明 (clear)	
		A20L-A4EG	綠色 (green)	
		A20L-A4EPW	純白色 (pure white)	
		A20L-A4ER	紅色 (red)	
		A20L-A4ES	藍色 (blue)	
<b>金屬框圓形平頭 (Flush with Metal Bezel)</b> 	<b>瞬時型 (Momentary)</b>	A20L-MS1EA	琥珀色 (amber)	
		A20L-MS1EC	透明 (clear)	
		A20L-MS1EG	綠色 (green)	
		A20L-MS1EPW	純白色 (pure white)	
		A20L-MS1ER	紅色 (red)	
		A20L-MS1ES	藍色 (blue)	
		A20L-MS1EW	乳白色 (white)	
	<b>交替型 (Maintained)</b>	A20L-MS1EY	黃色 (yellow)	
		A20L-AS1EA	琥珀色 (amber)	
		A20L-AS1EC	透明 (clear)	
		A20L-AS1EG	綠色 (green)	
		A20L-AS1EPW	純白色 (pure white)	
		A20L-AS1ER	紅色 (red)	
		A20L-AS1ES	藍色 (blue)	
A20L-AS1EW	乳白色 (white)			
A20L-AS1EY	黃色 (yellow)			

## 照光按鈕開關操作部 (Illuminated Pushbutton Operators)

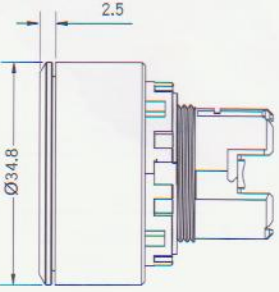
操作部

名稱 / 外觀 (Style)	動作類型 (Operation)	型號 (Type No.)	顏色 (Lens Color)	頭部尺寸 (Dimensions) Unit : mm
金屬鑲嵌框圓形平頭 (Flush with Metal Silhouette)  	瞬時型 (Momentary)	A20L-MU1EA	琥珀色 (amber)	
		A20L-MU1EC	透明 (clear)	
		A20L-MU1EG	綠色 (green)	
		A20L-MU1EPW	純白色 (pure white)	
		A20L-MU1ER	紅色 (red)	
		A20L-MU1ES	藍色 (blue)	
		A20L-MU1EW	乳白色 (white)	
		A20L-MU1EY	黃色 (yellow)	
	交替型 (Maintained)	A20L-AU1EA	琥珀色 (amber)	
		A20L-AU1EC	透明 (clear)	
		A20L-AU1EG	綠色 (green)	
		A20L-AU1EPW	純白色 (pure white)	
		A20L-AU1ER	紅色 (red)	
		A20L-AU1ES	藍色 (blue)	
		A20L-AU1EW	乳白色 (white)	
		A20L-AU1EY	黃色 (yellow)	

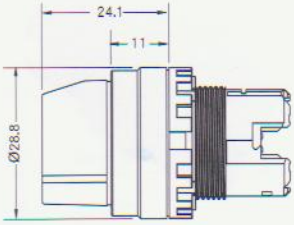

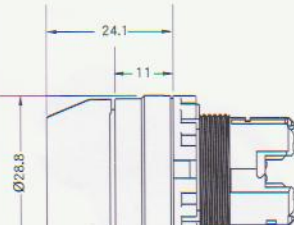
## 選擇開關操作部 (Selector Switches Operators)

名稱 / 外觀 (Style)	動作類型 (Operation)	型號 (Type No.)	顏色 (Lens Color)	頭部尺寸 (Dimensions) Unit : mm			
90° -2位置 / 標準旋鈕 (90° -2 Position / Knob Type)  	交替型 (Maintained)	A20S-2E	黑色 (black)				
		A20S-2EG	綠色 (green)				
		A20S-2ER	紅色 (red)				
		A20S-2ES	藍色 (blue)				
		A20S-2EW	白色 (white)				
		A20S-2EY	黃色 (yellow)				
	右復歸型 (Spring Return from Right)	A20S-21E	黑色 (black)				
		A20S-21EG	綠色 (green)				
		A20S-21ER	紅色 (red)				
		A20S-21ES	藍色 (blue)				
		A20S-21EW	白色 (white)				
		A20S-21EY	黃色 (yellow)				
		45° -3位置 / 標準旋鈕 (45° -3 Position / Knob Type)  	交替型 (Maintained)		A20S-3E	黑色 (black)	
					A20S-3EG	綠色 (green)	
A20S-3ER	紅色 (red)						
A20S-3ES	藍色 (blue)						
A20S-3EW	白色 (white)						
A20S-3EY	黃色 (yellow)						
右復歸型 (Spring Return from Right)	A20S-31E		黑色 (black)				
	A20S-31EG		綠色 (green)				
	A20S-31ER		紅色 (red)				
	A20S-31ES		藍色 (blue)				
	A20S-31EW		白色 (white)				
	A20S-31EY		黃色 (yellow)				
左復歸型 (Spring Return from Left)	A20S-32E	黑色 (black)					
	A20S-32EG	綠色 (green)					
	A20S-32ER	紅色 (red)					
	A20S-32ES	藍色 (blue)					
	A20S-32EW	白色 (white)					
	A20S-32EY	黃色 (yellow)					
雙向復歸型 (Spring Return from Tow-Way)	A20S-33E	黑色 (black)					
	A20S-33EG	綠色 (green)					
	A20S-33ER	紅色 (red)					
	A20S-33ES	藍色 (blue)					
	A20S-33EW	白色 (white)					
	A20S-33EY	黃色 (yellow)					

操作部

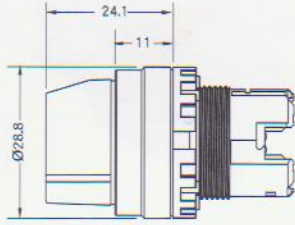

## 照光選擇開關操作部 (Illuminated Selector Switches Operators)

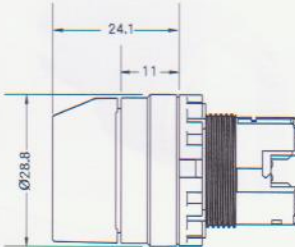
操作部

名稱 / 外觀 (Style)	動作類型 (Operation)	型號 (Type No.)	顏色 (Lens Color)	頭部尺寸 (Dimensions) Unit : mm			
90° -2位置 / 標準旋鈕 (90° -2 Position / Knob Type)  	交替型 (Maintained)	A20F-2EA	琥珀色 (amber)				
		A20F-2EG	綠色 (green)				
		A20F-2ER	紅色 (red)				
		A20F-2ES	藍色 (blue)				
		A20F-2EW	白色 (white)				
		A20F-2EY	黃色 (yellow)				
	右復歸型 (Spring Return from Right)	A20F-21EA	琥珀色 (amber)				
		A20F-21EG	綠色 (green)				
		A20F-21ER	紅色 (red)				
		A20F-21ES	藍色 (blue)				
		A20F-21EW	白色 (white)				
		A20F-21EY	黃色 (yellow)				
		45° -3位置 / 標準旋鈕 (45° -3 Position / Knob Type)  	交替型 (Maintained)		A20F-3EA	琥珀色 (amber)	
					A20F-3EG	綠色 (green)	
A20F-3ER	紅色 (red)						
A20F-3ES	藍色 (blue)						
A20F-3EW	白色 (white)						
A20F-3EY	黃色 (yellow)						
右復歸型 (Spring Return from Right)	A20F-31EA		琥珀色 (amber)				
	A20F-31EG		綠色 (green)				
	A20F-31ER		紅色 (red)				
	A20F-31ES		藍色 (blue)				
	A20F-31EW		白色 (white)				
	A20F-31EY		黃色 (yellow)				
左復歸型 (Spring Return from Left)	A20F-32EA	琥珀色 (amber)					
	A20F-32EG	綠色 (green)					
	A20F-32ER	紅色 (red)					
	A20F-32ES	藍色 (blue)					
	A20F-32EW	白色 (white)					
	A20F-32EY	黃色 (yellow)					
雙向復歸型 (Spring Return from Tow-Way)	A20F-33EA	琥珀色 (amber)					
	A20F-33EG	綠色 (green)					
	A20F-33ER	紅色 (red)					
	A20F-33ES	藍色 (blue)					
	A20F-33EW	白色 (white)					
	A20F-33EY	黃色 (yellow)					

## 鑰匙選擇開關操作部 (Key Selector Operators)

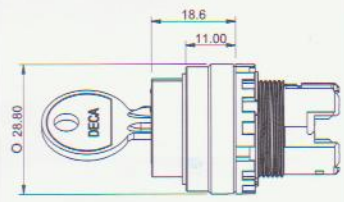
操作部

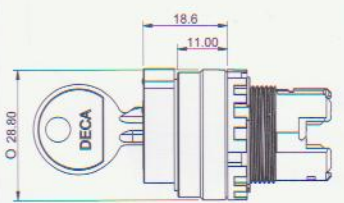
名稱 / 外觀 (Style)	動作類型 (Operation)	型號 (Type No.)	顏色 (Lens Color)	頭部尺寸 (Dimensions) Unit : mm
90° -2位置 / 標準旋鈕 (90° -2 Position / Knob Type)  	交替型 (Maintained)	A20K-2E	僅黑色 (Black only)	
	右復歸型 (Spring Return from Right)	A20K-21E		
45° -3位置 / 標準旋鈕 (45° -3 Position / Knob Type)  	交替型 (Maintained)	A20K-3E	僅黑色 (Black only)	
	右復歸型 (Spring Return from Right)	A20K-31E		
	左復歸型 (Spring Return from Left)	A20K-32E		
	雙向復歸型 (Spring Return from Tow-Way)	A20K-33E		

開關構造說明 (Switch Construction Instructions)

金屬鑲嵌框按鈕開關 (Pushbuttons)

A204B

按鈕開關  
(Pushbuttons)  
Page.73-79



按鈕開關操作部  
(Pushbutton Operators)  
Page.101



燈罩  
(Lens)  
Page.111



開關接點部  
(Contact Block  
Assemblies)  
Page.106-107



接點塊安裝轉接器  
(Contact Block  
Mounting Adapter)  
Page.109



接點塊  
(Contact Block)  
Page.108



接點塊  
(Contact Block)  
Page.108



接點塊  
(Contact Block)  
Page.108



# Ø22 A20 系列控制元件 (Metal Bezels)

## 按鈕開關 (Pushbuttons)

平頭形 (Flush)



A204B

燈泡 (Illumination Type)	動作類型 (Operation)	接點結構 (Contacts)	型號 (Type No.)	使用電壓記號 (Operating Voltage Code)	顏色記號① (Lens Color Code①)
無 (Without Lamp)	瞬時型 (Momentary)	1NO	A204B-M1E10①	無燈泡 (Without Lamp)	B: 黑色 G: 綠色 R: 紅色 S: 藍色 W: 白色 Y: 黃色
		1NC	A204B-M1E01①		
		2NO	A204B-M1E20①		
		2NC	A204B-M1E02①		
		1NO-1NC	A204B-M1E11①		
		3NO	A204B-M1E30①		
		3NC	A204B-M1E03①		
		2NO-1NC	A204B-M1E21①		
	1NO-2NC	A204B-M1E12①			
	交替型 (Maintained)	1NO	A204B-A1E10①		
		1NC	A204B-A1E01①		
		2NO	A204B-A1E20①		
		2NC	A204B-A1E02①		
		1NO-1NC	A204B-A1E11①		

### ■ 外型尺寸 (Dimensions) mm

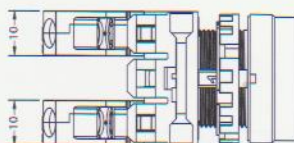

面板厚度 (Panel Thickness)  
0.8~6

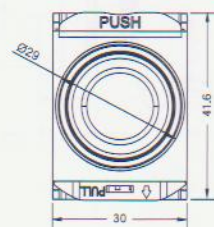
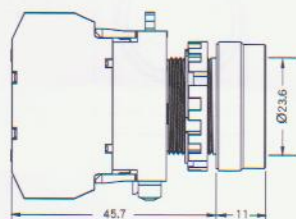

按鈕開關 (Pushbuttons)

凸頭形 (Extended)

A204B



燈泡 (Illumination Type)	動作類型 (Operation)	接點結構 (Contacts)	型號 (Type No.)	使用電壓記號 (Operating Voltage Code)	顏色記號① (Lens Color Code①)
無 (Without Lamp)	瞬時型 (Momentary)	1NO	A204B-M2E10①	無燈泡 (Without Lamp)	B: 黑色 G: 綠色 R: 紅色 S: 藍色 W: 白色 Y: 黃色
		1NC	A204B-M2E01①		
		2NO	A204B-M2E20①		
		2NC	A204B-M2E02①		
		1NO-1NC	A204B-M2E11①		
	交替型 (Maintained)	1NO	A204B-A2E10①		
		1NC	A204B-A2E01①		
		2NO	A204B-A2E20①		
		2NC	A204B-A2E02①		
		1NO-1NC	A204B-A2E11①		

■外型尺寸(Dimensions) mm

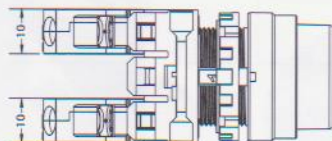

面板厚度 (Panel Thickness)  
0.8~6

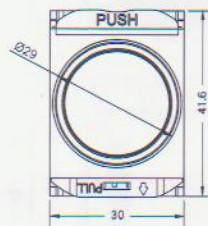
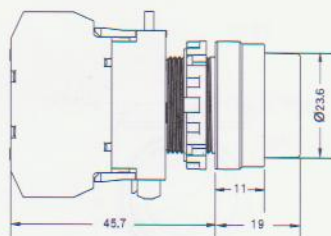

# Ø22 A20 系列控制元件 (Metal Bezels)

## 按鈕開關 (Pushbuttons)

φ 40mm 蘑菇頭形 (Mushroom φ 40mm)



A204B

燈泡 (Illumination Type)	動作類型 (Operation)	接點結構 (Contacts)	型號 (Type No.)	使用電壓記號 (Operating Voltage Code)	顏色記號① (Lens Color Code①)
無 (Without Lamp)	瞬時型 (Momentary)	1NO	A204B-M4E10①	無燈泡 (Without Lamp)	B : 黑色 G : 綠色 R : 紅色 S : 藍色 W : 白色 Y : 黃色
		1NC	A204B-M4E01①		
		2NO	A204B-M4E20①		
		2NC	A204B-M4E02①		
		1NO-1NC	A204B-M4E11①		
	交替型 (Maintained)	1NO	A204B-A4E10①		
		1NC	A204B-A4E01①		
		2NO	A204B-A4E20①		
		2NC	A204B-A4E02①		
		1NO-1NC	A204B-A4E11①		
					B : black G : green R : red S : blue W : white Y : yellow

### ■ 外型尺寸 (Dimensions) mm

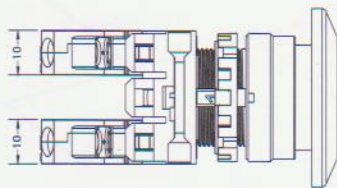

面板厚度 (Panel Thickness)  
0.8~6

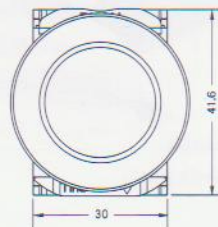
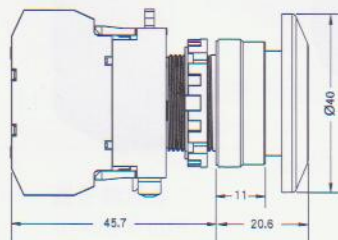

開關構造說明 ( Switch Construction Instructions )

金屬鑲嵌框照光按鈕開關 ( Illuminated Pushbuttons )

A204L

照光按鈕開關  
(Illuminated Pushbuttons)  
Page.77-79



照光按鈕開關操作部  
(Illuminated Pushbutton  
Operators)  
Page.102



燈泡  
(Lamp)  
Page.110



開關接點部  
( Contact Block  
Assemblies)  
Page.106-107



記名板  
(Marking Plate)  
Page.111



燈罩  
(Lens)  
Page.111



接點塊安裝轉接器  
(Contact Block  
Mounting Adapter)  
Page.109



接點塊  
(Contact Block)  
Page.108



全電壓轉接器  
(Full Voltage  
Adapter)  
Page.109



接點塊  
(Contact Block)  
Page.108



# Ø22 A20 系列控制元件 (Metal Bezels)

## 照光按鈕開關 (Illuminated Pushbuttons)

### 圓形凸頭 (Extended)



A204L

燈泡 (Illumination Type)	動作類型 (Operation)	接點結構 (Contacts)	型號 (Type No.)	使用電壓記號③ (Operating Voltage Code ③)	顏色記號② (Lens Color Code②)
無 (Without Lamp)	瞬時型 (Momentary)	1NO	A204L-M2E10Q0②	0 (無燈泡) (Without Lamp) 最大(max.) 250V AC/DC	A : 琥珀色      A : amber G : 綠色        G : green R : 紅色        R : red S : 藍色        S : blue W : 乳白色     W : white Y : 黃色        Y : yellow
		1NC	A204L-M2E01Q0②		
		2NO	A204L-M2E20Q0②		
		2NC	A204L-M2E02Q0②		
		1NO-1NC	A204L-M2E11Q0②		
	交替型 (Maintained)	1NO	A204L-A2E10Q0②		
		1NC	A204L-A2E01Q0②		
		2NO	A204L-A2E20Q0②		
		2NC	A204L-A2E02Q0②		
		1NO-1NC	A204L-A2E11Q0②		
LED	瞬時型 (Momentary)	1NO	A204L-M2E10Q③②	2 (6V AC/DC) 3 (12V AC/DC) 4 (24V AC/DC) H (110V AC/DC) M3 (230/240V AC/DC)	A : 琥珀色      A : amber G : 綠色        G : green PW : 純白色    PW : pure white C : 透明色     C : clear R : 紅色        R : red S : 藍色        S : blue W : 乳白色     W : white Y : 黃色        Y : yellow  內置LED : LAED-③② (Built-in LED lamp)
		1NC	A204L-M2E01Q③②		
		2NO	A204L-M2E20Q③②		
		2NC	A204L-M2E02Q③②		
		1NO-1NC	A204L-M2E11Q③②		
	交替型 (Maintained)	1NO	A204L-A2E10Q③②		
		1NC	A204L-A2E01Q③②		
		2NO	A204L-A2E20Q③②		
		2NC	A204L-A2E02Q③②		
		1NO-1NC	A204L-A2E11Q③②		
白熾燈泡 (Incandescent)	瞬時型 (Momentary)	1NO	A204L-M2E10Q③②	5 (6V AC/DC) 6 (12V AC/DC) 7 (24V AC/DC)	A : 琥珀色      A : amber G : 綠色        G : green R : 紅色        R : red S : 藍色        S : blue W : 乳白色     W : white Y : 黃色        Y : yellow  內置白熾燈泡 : LA-T③ (Built-in incandescent lamp)
		1NC	A204L-M2E01Q③②		
		2NO	A204L-M2E20Q③②		
		2NC	A204L-M2E02Q③②		
		1NO-1NC	A204L-M2E11Q③②		
	交替型 (Maintained)	1NO	A204L-A2E10Q③②		
		1NC	A204L-A2E01Q③②		
		2NO	A204L-A2E20Q③②		
		2NC	A204L-A2E02Q③②		
		1NO-1NC	A204L-A2E11Q③②		

### ■ 外型尺寸(Dimensions) mm

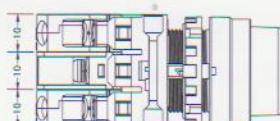

面板厚度 (Panel Thickness)  
0.8~6

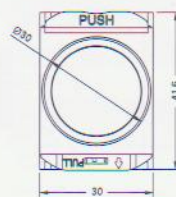
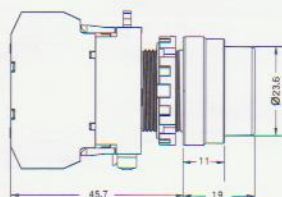

照光按鈕開關 (Illuminated Pushbuttons)

全護圈圓形凸頭 (Extended with Full Shroud)

A204L



燈泡 (Illumination Type)	動作類型 (Operation)	接點結構 (Contacts)	型號 (Type No.)	使用電壓記號③ (Operating Voltage Code③)	顏色記號② (Lens Color Code②)
無 (Without Lamp)	瞬時型 (Momentary)	1NO	A204L-MF2E10Q0②	0 (無燈泡) (Without Lamp) 最大(max.) 250V AC/DC	A : 琥珀色      A : amber G : 綠色        G : green R : 紅色        R : red S : 藍色        S : blue W : 乳白色     W : white Y : 黃色        Y : yellow
		1NC	A204L-MF2E01Q0②		
		2NO	A204L-MF2E20Q0②		
		2NC	A204L-MF2E02Q0②		
		1NO-1NC	A204L-MF2E11Q0②		
	交替型 (Maintained)	1NO	A204L-AF2E10Q0②		
		1NC	A204L-AF2E01Q0②		
		2NO	A204L-AF2E20Q0②		
		2NC	A204L-AF2E02Q0②		
		1NO-1NC	A204L-AF2E11Q0②		
LED	瞬時型 (Momentary)	1NO	A204L-MF2E10Q3②	2 (6V AC/DC) 3 (12V AC/DC) 4 (24V AC/DC) H (110V AC/DC) M3 (230/240V AC/DC)	A : 琥珀色      A : amber G : 綠色        G : green PW : 純白色    PW : pure white C : 透明色     C : clear R : 紅色        R : red S : 藍色        S : blue W : 乳白色     W : white Y : 黃色        Y : yellow 內置LED : LAED-③② (Built-in LED lamp)
		1NC	A204L-MF2E01Q3②		
		2NO	A204L-MF2E20Q3②		
		2NC	A204L-MF2E02Q3②		
		1NO-1NC	A204L-MF2E11Q3②		
	交替型 (Maintained)	1NO	A204L-AF2E10Q3②		
		1NC	A204L-AF2E01Q3②		
		2NO	A204L-AF2E20Q3②		
		2NC	A204L-AF2E02Q3②		
		1NO-1NC	A204L-AF2E11Q3②		
白熾燈泡 (Incandescent)	瞬時型 (Momentary)	1NO	A204L-MF2E10Q3②	5 (6V AC/DC) 6 (12V AC/DC) 7 (24V AC/DC)	A : 琥珀色      A : amber G : 綠色        G : green R : 紅色        R : red S : 藍色        S : blue W : 乳白色     W : white Y : 黃色        Y : yellow 內置白熾燈泡 : LA-T③ (Built-in incandescent lamp)
		1NC	A204L-MF2E01Q3②		
		2NO	A204L-MF2E20Q3②		
		2NC	A204L-MF2E02Q3②		
		1NO-1NC	A204L-MF2E11Q3②		
	交替型 (Maintained)	1NO	A204L-AF2E10Q3②		
		1NC	A204L-AF2E01Q3②		
		2NO	A204L-AF2E20Q3②		
		2NC	A204L-AF2E02Q3②		
		1NO-1NC	A204L-AF2E11Q3②		

■外型尺寸(Dimensions) mm

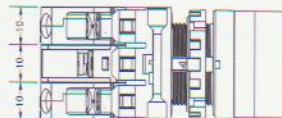

面板厚度 (Panel Thickness)  
0.8~6

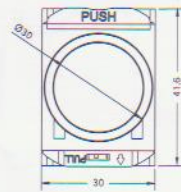
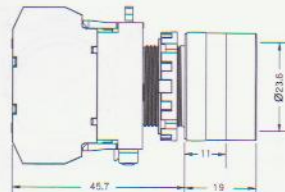

照光按鈕開關 (Illuminated Pushbuttons)

φ 40mm 蘑菇頭形 (Mushroom φ 40mm)



A204L

燈泡 (Illumination Type)	動作類型 (Operation)	接點結構 (Contacts)	型號 (Type No.)	使用電壓記號③ (Operating Voltage Code③)	顏色記號② (Lens Color Code②)
無 (Without Lamp)	瞬時型 (Momentary)	1NO	A204L-M4E10Q0②	0 (無燈泡) (Without Lamp) 最大(max.) 250V AC/DC	A : 琥珀色      A : amber G : 綠色        G : green R : 紅色        R : red S : 藍色        S : blue W : 乳白色      W : white Y : 黃色        Y : yellow
		1NC	A204L-M4E01Q0②		
		2NO	A204L-M4E20Q0②		
		2NC	A204L-M4E02Q0②		
		1NO-1NC	A204L-M4E11Q0②		
	交替型 (Maintained)	1NO	A204L-A4E10Q0②		
		1NC	A204L-A4E01Q0②		
		2NO	A204L-A4E20Q0②		
		2NC	A204L-A4E02Q0②		
		1NO-1NC	A204L-A4E11Q0②		
LED	瞬時型 (Momentary)	1NO	A204L-M4E10Q③②	2 (6V AC/DC) 3 (12V AC/DC) 4 (24V AC/DC) H (110V AC/DC) M3 (230/240V AC/DC)	A : 琥珀色      A : amber G : 綠色        G : green PW : 純白色      PW : pure white C : 透明色       C : clear R : 紅色        R : red S : 藍色        S : blue W : 乳白色      W : white Y : 黃色        Y : yellow  內置LED : LAED-③② (Built-in LED lamp)
		1NC	A204L-M4E01Q③②		
		2NO	A204L-M4E20Q③②		
		2NC	A204L-M4E02Q③②		
		1NO-1NC	A204L-M4E11Q③②		
	交替型 (Maintained)	1NO	A204L-A4E10Q③②		
		1NC	A204L-A4E01Q③②		
		2NO	A204L-A4E20Q③②		
		2NC	A204L-A4E02Q③②		
		1NO-1NC	A204L-A4E11Q③②		
白熾燈泡 (Incandescent)	瞬時型 (Momentary)	1NO	A204L-M4E10Q③②	5 (6V AC/DC) 6 (12V AC/DC) 7 (24V AC/DC)	A : 琥珀色      A : amber G : 綠色        G : green R : 紅色        R : red S : 藍色        S : blue W : 乳白色      W : white Y : 黃色        Y : yellow  內置白熾燈泡 : LA-T③ (Built-in incandescent lamp)
		1NC	A204L-M4E01Q③②		
		2NO	A204L-M4E20Q③②		
		2NC	A204L-M4E02Q③②		
		1NO-1NC	A204L-M4E11Q③②		
	交替型 (Maintained)	1NO	A204L-A4E10Q③②		
		1NC	A204L-A4E01Q③②		
		2NO	A204L-A4E20Q③②		
		2NC	A204L-A4E02Q③②		
		1NO-1NC	A204L-A4E11Q③②		

■ 外型尺寸(Dimensions) mm



面板厚度 (Panel Thickness)  
0.8~6

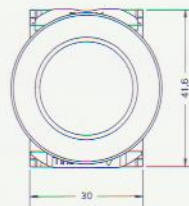
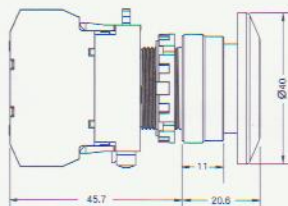

開關構造說明 ( Switch Construction Instructions )

A204S 金屬鑲嵌框選擇開關 ( Selector Switches )

選擇開關  
(Selector Switches)  
Page.81-86

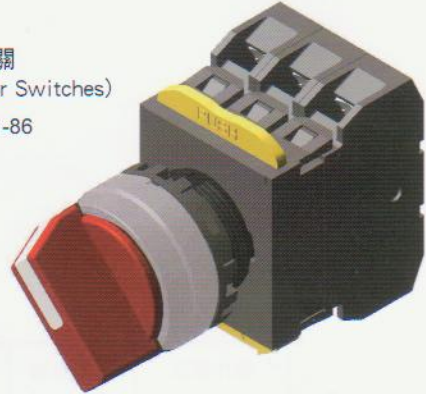

選擇開關操作部  
(Selector Switches  
Operators)  
Page.103



開關接點部  
( Contact Block  
Assemblies)  
Page.106-107



接點塊安裝轉接器  
(Contact Block  
Mounting Adapter)  
Page.109



接點塊  
(Contact Block)  
Page.108



接點塊  
(Contact Block)  
Page.108



接點塊  
(Contact Block)  
Page.108



選擇開關 (Selector Switches)

90° -2位置 / 交替型標準旋鈕 (90° -2 Position / Knob Type with Maintained)



A204S

位置數 (No. of Positions)	接點結構 (Contacts)			旋鈕位置 (Operator Position)			型號 (Type No.)	使用電壓記號 (Operating Voltage Code)	顏色記號② (Lens Color Code②)	
	記號 (Configuration)	位置 (Mounting)	類型 (Position)	L	R	---				
90° -2位置 / 交替型標準 旋鈕 (90° -2 Position / Knob Type with Maintained)	1NO (10)	1	NO		●		A204S-2E10②	無燈泡 (Without Lamp)	blank : 黑色 G : 綠色 R : 紅色 S : 藍色 W : 白色 Y : 黃色	
		2								
		3								
	1NC (01)	1								A204S-2E01②
		2								
		3	NC	●						
	2NO (20)	1	NO		●		A204S-2E20②			
		2								
		3	NO		●					
	2NC (02)	1	NC		●		A204S-2E02②			
		2								
		3	NC	●						
1NO-1NC (11)	1	NO		●		A204S-2E11②				
	2									
	3	NC	●							
3NO (30)	1	NO		●		A204S-2E30②				
	2	NO		●						
	3	NO		●						
3NC (03)	1	NC	●			A204S-2E03②				
	2	NC	●							
	3	NC	●							
2NO-1NC (21)	1	NO		●		A204S-2E21②				
	2	NO		●						
	3	NC	●							
1NO-2NC (12)	1	NO		●		A204S-2E12②				
	2	NC	●							
	3	NC	●							

■外型尺寸(Dimensions) mm

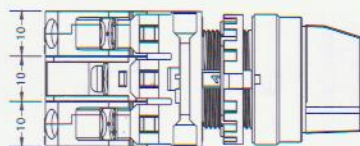

面板厚度 (Panel Thickness)  
0.8~6

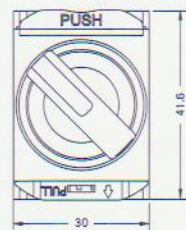
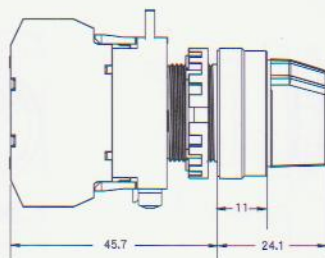

選擇開關 ( Selector Switches )

90° -2位置 / 右復歸型標準旋鈕 (90° -2 Position / Knob Type with Spring Return from Right)

A204S

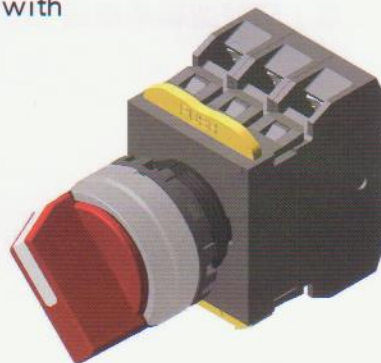

位置數 (No. of Positions)	接點結構 (Contacts)			旋鈕位置 (Operator Position)			型號 (Type No.)	使用電壓記號 (Operating Voltage Code)	顏色記號② (Lens Color Code②)	
	記號 (Configuration)	位置 (Mounting)	類型 (Position)	L	R	---				
90° -2位置 / 右復歸型標 準旋鈕 (90° -2 Position / Knob Type with Spring Return from Right)	1NO (10)	1	NO		●		A204S-21E10②	無燈泡 (Without Lamp)	blank : 黑色 G : 綠色 R : 紅色 S : 藍色 W : 白色 Y : 黃色	
		2								
		3								
	1NC (01)	1								A204S-21E01②
		2								
		3	NC	●						
	2NO (20)	1	NO		●		A204S-21E20②			
		2								
		3	NO		●					
	2NC (02)	1	NC		●		A204S-21E02②			
		2								
		3	NC	●						
	1NO-1NC (11)	1	NO		●		A204S-21E11②			
		2								
		3	NC	●						
	3NO (30)	1	NO		●		A204S-21E30②			
		2	NO		●					
		3	NO		●					
	3NC (03)	1	NC	●			A204S-21E03②			
		2	NC	●						
		3	NC	●						
	2NO-1NC (21)	1	NO		●		A204S-21E21②			
		2	NO		●					
		3	NC	●						
1NO-2NC (12)	1	NO		●		A204S-21E12②				
	2	NC	●							
	3	NC	●							

■外型尺寸(Dimensions) mm

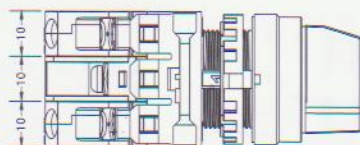

面板厚度 ( Panel Thickness )  
0.8~6

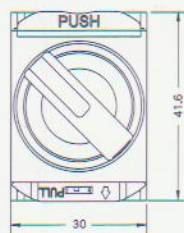
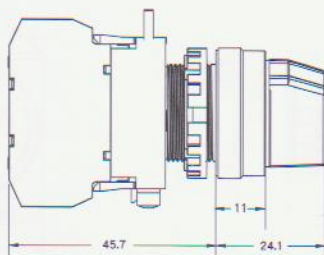

選擇開關 (Selector Switches)

45° -3位置 / 交替型標準旋鈕 (45° -3 Position / Knob Type with Maintained)



A204S

位置數 (No. of Positions)	接點結構 (Contacts)			旋鈕位置 (Operator Position)			型號 (Type No.)	使用電壓記號 (Operating Voltage Code)	顏色記號② (Lens Color Code②)	
	記號 (Configuration)	位置 (Mounting)	類型 (Position)	L	C	R				
45° -3位置 / 交替型標準 旋鈕 (45° -3 Position / Knob Type with Maintained)	2NO (20)	1	NO	●			A204S-3E20②	無燈泡 (Without Lamp)	blank : 黑色 G : 綠色 R : 紅色 S : 藍色 W : 白色 Y : 黃色	
		2								
		3	NO			●				
	2NO (20N1)	1			●					A204S-3E20N1②
		2	NO			●				
		3	NO			●				
	2NC (02)	1	NC							A204S-3E02②
		2								
		3	NC							
	2NC (02N1)	1				●				A204S-3E02N1②
		2	NC							
		3	NC							
	1NO-1NC (11)	1	NO		●					A204S-3E11②
		2								
		3	NC							
	1NO-1NC (11N1)	1	NC							A204S-3E11N1②
		2								
		3	NO			●				
	1NO-1NC (11N2)	1	NO		●					A204S-3E11N2②
		2	NC				●			
3										
1NO-1NC (11N3)	1				●		A204S-3E11N3②			
	2	NC								
	3	NO				●				
1NO-1NC (11N4)	1			●			A204S-3E11N4②			
	2	NO				●				
	3	NC								
3NO (30)	1	NO		●			A204S-3E30②			
	2	NO		●						
	3	NO		●						
3NC (03)	1	NC					A204S-3E03②			
	2	NC								
	3	NC								
2NO-1NC (21)	1	NO		●			A204S-3E21②			
	2	NC			●					
	3	NO				●				
1NO-2NC (12)	1	NC					A204S-3E12②			
	2	NO		●		●				
	3	NC								

■外型尺寸(Dimensions) mm

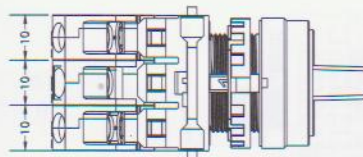

面板厚度 (Panel Thickness)  
0.8~6

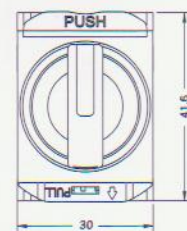
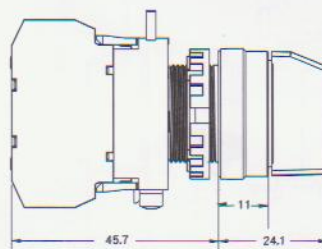

選擇開關 (Selector Switches)

45° -3位置 / 右復歸型標準旋鈕 (45° -3 Position / Knob Type with Spring Return from Right)

A204S



位置數 (No. of Positions)	接點結構 (Contacts)			旋鈕位置 (Operator Position)			型號 (Type No.)	使用電壓記號 (Operating Voltage Code)	顏色記號② (Lens Color Code②)	
	記號 (Configuration)	位置 (Mounting)	類型 (Position)	L	C	R				
45° -3位置 右復歸型標準旋鈕 (45° -3 Position / Knob Type with Spring Return from Right)  L C R ↓ ↘	2NO (20)	1	NO	●			A204S-31E20②	無燈泡 (Without Lamp)	blank : 黑色 G : 綠色 R : 紅色 S : 藍色 W : 白色 Y : 黃色  blank : black G : green R : red S : blue W : white Y : yellow	
		2								
		3	NO			●				
	2NO (20N1)	1			●					A204S-31E20N1②
		2	NO	●		●				
		3	NO			●				
	2NC (02)	1	NC		■					A204S-31E02②
		2								
		3	NC	■						
	2NC (02N1)	1			■					A204S-31E02N1②
		2	NC		●					
		3	NC	■						
	1NO-1NC (11)	1	NO	●						A204S-31E11②
		2								
		3	NC	■						
	1NO-1NC (11N1)	1	NC		■					A204S-31E11N1②
		2								
		3	NO	●		●				
1NO-1NC (11N2)	1	NO	●				A204S-31E11N2②			
	2	NC								
	3									
1NO-1NC (11N3)	1			●			A204S-31E11N3②			
	2	NC		●						
	3	NO			●					
1NO-1NC (11N4)	1			●			A204S-31E11N4②			
	2	NO	●		●					
	3	NC	■							
3NO (30)	1	NO	●				A204S-31E30②			
	2	NO	●		●					
	3	NO	●		●					
3NC (03)	1	NC		■			A204S-31E03②			
	2	NC		■						
	3	NC	■							
2NO-1NC (21)	1	NO	●				A204S-31E21②			
	2	NC		●						
	3	NO			●					
1NO-2NC (12)	1	NC		■			A204S-31E12②			
	2	NO	●		●					
	3	NC	■							

■外型尺寸(Dimensions) mm

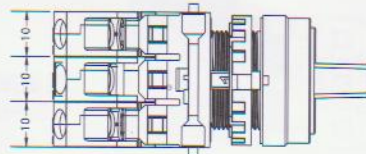

面板厚度 (Panel Thickness)  
0.8~6

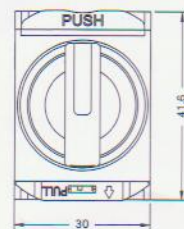
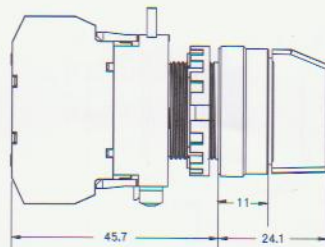

選擇開關 (Selector Switches)

45° -3位置 / 左復歸型標準旋鈕 (45° -3 Position / Knob Type with Spring Return from Left)



A204S

位置數 (No. of Positions)	接點結構 (Contacts)			旋鈕位置 (Operator Position)			型號 (Type No.)	使用電壓記號 (Operating Voltage Code)	顏色記號② (Lens Color Code②)	
	記號 (Configuration)	位置 (Mounting)	類型 (Position)	L	C	R				
45° -3位置 左復歸型標準旋鈕 (45° -3 Position / Knob Type with Spring Return from Left)	2NO (20)	1	NO	●			A204S-32E20②	無燈泡 (Without Lamp)	blank : 黑色 G : 綠色 R : 紅色 S : 藍色 W : 白色 Y : 黃色	
		2								
		3	NO			●				
	2NO (20N1)	1								A204S-32E20N1②
		2	NO	●		●				
		3	NO			●				
	2NC (02)	1	NC							A204S-32E02②
		2								
		3	NC							
	2NC (02N1)	1								A204S-32E02N1②
		2	NC		●					
		3	NC			●				
	1NO-1NC (11)	1	NO	●						A204S-32E11②
		2								
		3	NC							
	1NO-1NC (11N1)	1	NC							A204S-32E11N1②
		2								
		3	NO			●				
1NO-1NC (11N2)	1	NO	●				A204S-32E11N2②			
	2	NC								
	3									
1NO-1NC (11N3)	1						A204S-32E11N3②			
	2	NC		●						
	3	NO			●					
1NO-1NC (11N4)	1						A204S-32E11N4②			
	2	NO	●		●					
	3	NC								
3NO (30)	1	NO	●				A204S-32E30②			
	2	NO	●		●					
	3	NO			●					
3NC (03)	1	NC					A204S-32E03②			
	2	NC								
	3	NC								
2NO-1NC (21)	1	NO	●				A204S-32E21②			
	2	NC		●						
	3	NO			●					
1NO-2NC (12)	1	NC					A204S-32E12②			
	2	NO	●		●					
	3	NC								

■外型尺寸(Dimensions) mm

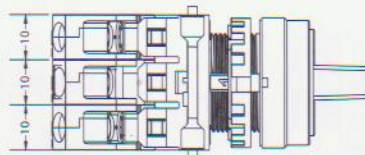

面板厚度 ( Panel Thickness )  
0.8~6

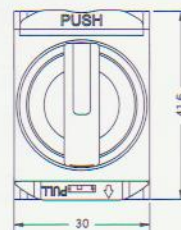
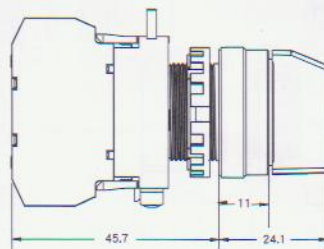

選擇開關 (Selector Switches)

45° -3位置 / 雙向復歸型標準旋鈕 (45° -3 Position / Knob Type with Spring Return from Two-Way)

A204S



位置數 (No. of Positions)	接點結構 (Contacts)			旋鈕位置 (Operator Position)			型號 (Type No.)	使用電壓記號 (Operating Voltage Code)	顏色記號② (Lens Color Code②)	
	記號 (Configuration)	位置 (Mounting)	類型 (Position)	L	C	R				
45° -3位置 / 雙向復歸型 標準旋鈕 (45° -3 Position / Knob Type with Spring Return from Two-Way)  L C R ↕	2NO (20)	1	NO	●			A204S-33E20②	無燈泡 (Without Lamp)	blank : 黑色 G : 綠色 R : 紅色 S : 藍色 W : 白色 Y : 黃色	
		2								
		3	NO			●				
	2NO (20N1)	1								A204S-33E20N1②
		2	NO	●						
		3	NO			●				
	2NC (02)	1	NC		■					A204S-33E02②
		2								
		3	NC		■					
	2NC (02N1)	1								A204S-33E02N1②
		2	NC		●					
		3	NC		■					
	1NO-1NC (11)	1	NO	●						A204S-33E11②
		2								
		3	NC		■					
	1NO-1NC (11N1)	1	NC			■				A204S-33E11N1②
		2								
		3	NO			●				
	1NO-1NC (11N2)	1	NO	●						A204S-33E11N2②
		2	NC							
3					●					
1NO-1NC (11N3)	1						A204S-33E11N3②			
	2	NC		●						
	3	NO			●					
1NO-1NC (11N4)	1						A204S-33E11N4②			
	2	NO	●							
	3	NC		■						
3NO (30)	1	NO	●				A204S-33E30②			
	2	NO	●							
	3	NO			●					
3NC (03)	1	NC		■			A204S-33E03②			
	2	NC		●						
	3	NC		■						
2NO-1NC (21)	1	NO	●				A204S-33E21②			
	2	NC		●						
	3	NO			●					
1NO-2NC (12)	1	NC			■		A204S-33E12②			
	2	NO	●							
	3	NC		■						

■外型尺寸(Dimensions)mm

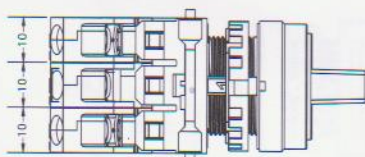

面板厚度 (Panel Thickness)  
0.8~6

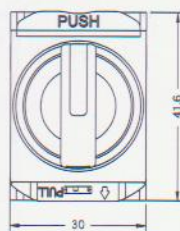
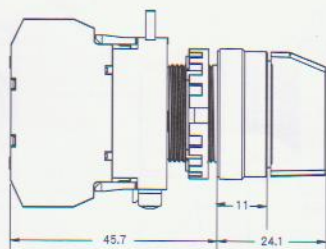

開關構造說明 ( Switch Construction Instructions )

金屬鑲嵌框照光選擇開關 ( Illuminated Selector Switches )

A204F

照光選擇開關  
( Illuminated Selector  
Switches )  
Page.88-93

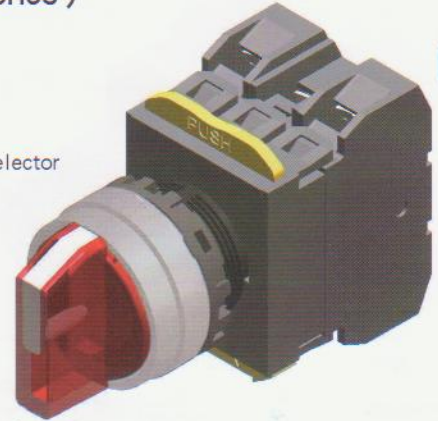

照光選擇開關操作部  
( Illuminated Selector  
Switches Operators )  
Page.104



燈泡  
( Lamp )  
Page.110



開關接點部  
( Contact Block  
Assemblies )  
Page.106-107

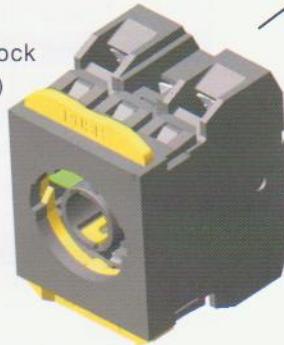

接點塊安裝轉接器  
( Contact Block  
Mounting Adapter )  
Page.109



接點塊  
( Contact Block )  
Page.108



全電壓轉接器  
( Full Voltage  
Adapter )  
Page.108



接點塊  
( Contact Block )  
Page.108



照光選擇開關 (Illuminated Selector Switches)

90° -2位置 / 交替型標準旋鈕 (90° -2 Position / Knob Type with Maintained)

A204F



位置數 (No. of Positions)	接點結構 (Contacts)			旋鈕位置 (Operator Position)			型號 (Type No.)	使用電壓記號③ (Operating Voltage Code③)	顏色記號② (Lens Color Code②)
	記號 (Configuration)	位置 (Mounting)	類型 (Position)	L	R	---			
90° -2位置 / 交替型標準 旋鈕 (90° -2 Position / Knob Type with Maintained)	1NO (10)	1	NO		●		A204F-2E10Q③②	0 (無燈泡) (Without Lamp) 最大(max.) 250V AC/DC	A : 琥珀色 G : 綠色 R : 紅色 S : 藍色 W : 乳白色 Y : 黃色  A : amber G : green R : red S : blue W : white Y : yellow
		2	Lamp						
		3							
	1NC (01)	1			●		A204F-2E01Q③②	內置LED : LAED-③② (Built-in LED lamp) 2 (6V AC/DC) 3 (12V AC/DC) 4 (24V AC/DC) H (110V AC/DC) M3 (230/240V AC/ DC)	
		2	Lamp						
		3	NC	●					
	2NO (20)	1	NO		●		A204F-2E20Q③②		
		2	Lamp						
		3	NO		●				
	2NC (02)	1	NC		●		A204F-2E02Q③②	內置白熾燈泡 : LA-T③ (Built-in incandescent lamp)	
		2	Lamp						
		3	NC	●					
1NO-1NC (11)	1	NO		●		A204F-2E11Q③②	5 (6V AC/DC) 6 (12V AC/DC) 7 (24V AC/DC)		
	2	Lamp							
	3	NC	●						

■外型尺寸(Dimensions) mm

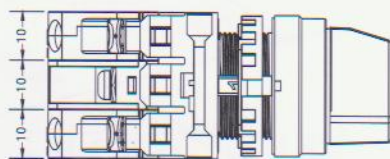

面板厚度 ( Panel Thickness )  
0.8~6

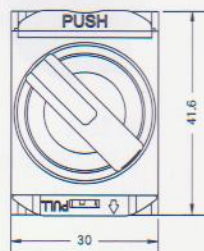
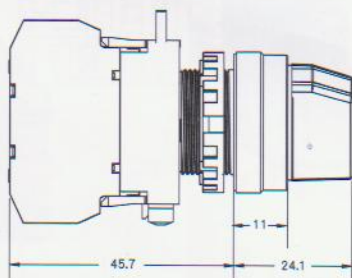



照光選擇開關 (Illuminated Selector Switches)

90° -2位置 / 右復歸型標準旋鈕 (90° -2 Position / Knob Type with Spring Return from Right)



A204F

位置數 (No. of Positions)	接點結構 (Contacts)			旋鈕位置 (Operator Position)			型號 (Type No.)	使用電壓記號③ (Operating Voltage Code③)	顏色記號② (Lens Color Code②)
	記號 (Configuration)	位置 (Mounting)	類型 (Position)	L	R	---			
90° -2位置 / 右復歸型標準旋鈕 (90° -2 Position / Knob Type with Spring Return from Right)  L R ↙ ↘	1NO (10)	1	NO		●		A204F-21E10Q③②	0 (無燈泡) (Without Lamp) 最大(max.) 250V AC/DC  內置LED: LAED-③② (Built-in LED lamp) 2 (6V AC/DC) 3 (12V AC/DC) 4 (24V AC/DC) H (110V AC/DC) M3 (230/240V AC/DC)  內置白熾燈泡: LA-T③ (Built-in incandescent lamp) 5 (6V AC/DC) 6 (12V AC/DC) 7 (24V AC/DC)	A : 琥珀色 G : 綠色 R : 紅色 S : 藍色 W : 乳白色 Y : 黃色  A : amber G : green R : red S : blue W : white Y : yellow
		2	Lamp						
		3							
	1NC (01)	1			●		A204F-21E01Q③②		
		2	Lamp						
		3	NC	●					
	2NO (20)	1	NO		●		A204F-21E20Q③②		
		2	Lamp						
		3	NO		●				
	2NC (02)	1	NC		●		A204F-21E02Q③②		
		2	Lamp						
		3	NC	●					
1NO-1NC (11)	1	NO		●		A204F-21E11Q③②			
	2	Lamp							
	3	NC	●						

■外型尺寸(Dimensions) mm

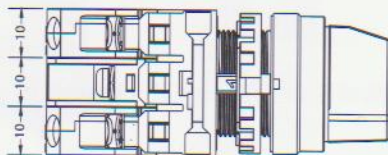

面板厚度 (Panel Thickness)  
0.8~6

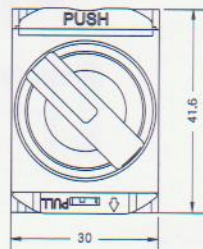
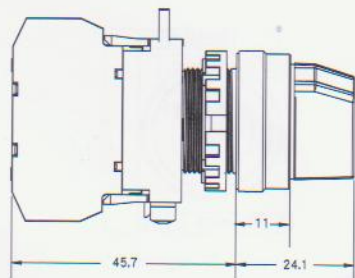

照光選擇開關 (Illuminated Selector Switches)

45° -3位置 / 交替型標準旋鈕 (45° -3 Position / Knob Type with Maintained)

A204F



位置數 (No. of Positions)	接點結構 (Contacts)			旋鈕位置 (Operator Position)			型號 (Type No.)	使用電壓記號③ (Operating Voltage Code③)	顏色記號② (Lens Color Code②)
	記號 (Configuration)	位置 (Mounting)	類型 (Position)	L	C	R			
45° -3位置 / 交替型標準 旋鈕 (45° -3 Position / Knob Type with Maintained)  L C R ↓	2NO (20)	1	NO	●			A204F-3E20Q③②	0 (無燈泡) (Without Lamp) 最大(max.) 250V AC/DC	A : 琥珀色 G : 綠色 R : 紅色 S : 藍色 W : 乳白色 Y : 黃色  A : amber G : green R : red S : blue W : white Y : yellow
		2	Lamp						
		3	NO			●			
	2NC (02)	1	NC		■		A204F-3E02Q③②	內置LED: LAED-③② (Built-in LED lamp) 2 (6V AC/DC) 3 (12V AC/DC) 4 (24V AC/DC) H (110V AC/DC) M3 (230/240V AC/ DC)	
		2	Lamp						
		3	NC		■				
	1NO-1NC (11)	1	NO	●			A204F-3E11Q③②	內置白熾燈泡: LA-T③ (Built-in incandescent lamp)	
		2	Lamp						
		3	NC		■				
	1NO-1NC (11N1)	1	NC			■	A204F-3E11N1Q③②	5 (6V AC/DC) 6 (12V AC/DC) 7 (24V AC/DC)	
		2	Lamp						
		3	NO			●			

■外型尺寸(Dimensions) mm

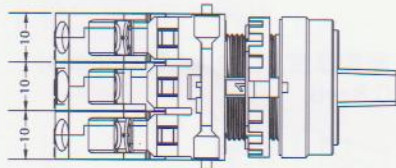

面板厚度 (Panel Thickness)  
0.8~6

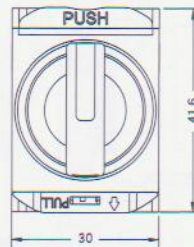
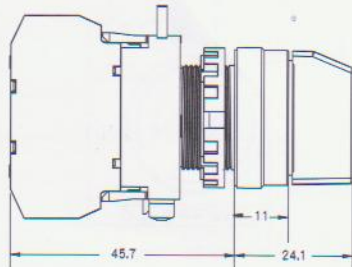

照光選擇開關 (Illuminated Selector Switches)

45° -3位置 / 右復歸型標準旋鈕 (45° -3 Position / Knob Type with Spring Return from Right)



A204F

位置數 (No. of Positions)	接點結構 (Contacts)			旋鈕位置 (Operator Position)			型號 (Type No.)	使用電壓記號③ (Operating Voltage Code③)	顏色記號② (Lens Color Code②)
	記號 (Configuration)	位置 (Mounting)	類型 (Position)	L	C	R			
45° -3位置 右復歸型標準旋鈕 (45° -3 Position / Knob Type with Spring Return from Right)	2NO (20)	1	NO	●			A204F-31E20Q③②	0 (無燈泡) (Without Lamp) 最大(max.) 250V AC/DC	A : 琥珀色 G : 綠色 R : 紅色 S : 藍色 W : 乳白色 Y : 黃色  A : amber G : green R : red S : blue W : white Y : yellow
		2	Lamp						
		3	NO			●			
	2NC (02)	1	NC		■		A204F-31E02Q③②	內置LED: LAED-③② (Built-in LED lamp) 2 (6V AC/DC) 3 (12V AC/DC) 4 (24V AC/DC) H (110V AC/DC) M3 (230/240V AC/DC)	
		2	Lamp						
		3	NC		■				
	1NO-1NC (11)	1	NO	●			A204F-31E11Q③②	內置白熾燈泡: LA-T③ (Built-in incandescent lamp)	
		2	Lamp						
		3	NC		■				
	1NO-1NC (11N1)	1	NC			■	A204F-31E11N1Q③②	5 (6V AC/DC) 6 (12V AC/DC) 7 (24V AC/DC)	
		2	Lamp						
		3	NO			●			

■外型尺寸(Dimensions) mm

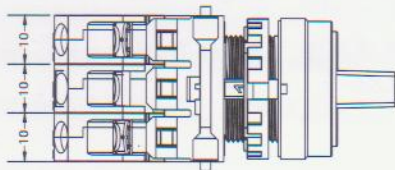

面板厚度 (Panel Thickness)  
0.8~6

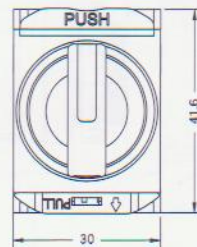
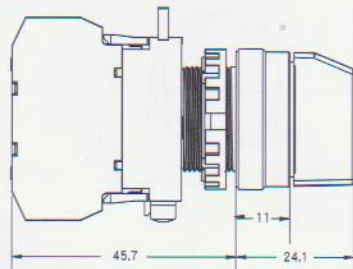

照光選擇開關 (Illuminated Selector Switches)

45° -3位置 / 左復歸型標準旋鈕 (45° -3 Position / Knob Type with Spring Return from Left)

A204F



位置數 (No. of Positions)	接點結構 (Contacts)			旋鈕位置 (Operator Position)			型號 (Type No.)	使用電壓記號③ (Operating Voltage Code③)	顏色記號② (Lens Color Code②)
	記號 (Configuration)	位置 (Mounting)	類型 (Position)	L	C	R			
45° -3位置 / 左復歸型標 準旋鈕 (45° -3 Position / Knob Type with Spring Return from Left)  L C R ↙ ↓	2NO (20)	1	NO	●			A204F-32E20Q③②	0 (無燈泡) (Without Lamp) 最大(max.) 250V AC/DC	A : 琥珀色 G : 綠色 R : 紅色 S : 藍色 W : 乳白色 Y : 黃色
		2	Lamp						
		3	NO			●			
	2NC (02)	1	NC		■		A204F-32E02Q③②	內置LED : LAED-③② (Built-in LED lamp) 2 (6V AC/DC) 3 (12V AC/DC) 4 (24V AC/DC) H (110V AC/DC) M3 (230/240V AC/ DC)	
		2	Lamp						
		3	NC		■				
1NO-1NC (11)	1	NO	●			A204F-32E11Q③②	內置白熾燈泡 : LA-T③ (Built-in incandescent lamp)		
	2	Lamp							
	3	NC		■					
1NO-1NC (11N1)	1	NC			■	A204F-32E11N1Q③②	5 (6V AC/DC) 6 (12V AC/DC) 7 (24V AC/DC)		
	2	Lamp							
	3	NO			●				

■外型尺寸(Dimensions) mm

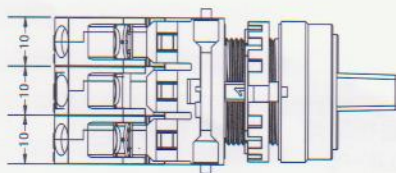

面板厚度 (Panel Thickness)  
0.8~6

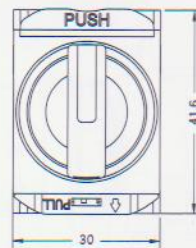
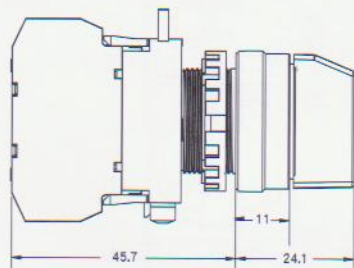

# Ø22 A20 系列控制元件 (Metal Bezels)

## 照光選擇開關 (Illuminated Selector Switches)

45° -3位置 / 雙向復歸型標準旋鈕 (45° -3 Position / Knob Type with Spring Return from Two-Way)



A204F

位置數 (No. of Positions)	接點結構 (Contacts)			旋鈕位置 (Operator Position)			型號 (Type No.)	使用電壓記號③ (Operating Voltage Code③)	顏色記號② (Lens Color Code②)
	記號 (Configuration)	位置 (Mounting)	類型 (Position)	L	C	R			
45° -3位置 / 雙向復歸型 標準旋鈕 (45° -3 Position / Knob Type with Spring Return from Two-Way)	2NO (20)	1	NO	●			A204F-33E20Q③②	0 (無燈泡) (Without Lamp) 最大(max.) 250V AC/DC	A : 琥珀色 G : 綠色 R : 紅色 S : 藍色 W : 乳白色 Y : 黃色  A : amber G : green R : red S : blue W : white Y : yellow
		2	Lamp						
		3	NO			●			
	2NC (02)	1	NC		■		A204F-33E02Q③②	內置LED: LAED-③② (Built-in LED lamp) 2 (6V AC/DC) 3 (12V AC/DC) 4 (24V AC/DC) H (110V AC/DC) M3 (230/240V AC/ DC)	
		2	Lamp						
		3	NC	■					
	1NO-1NC (11)	1	NO	●			A204F-33E11Q③②	內置白熾燈泡: LA-T③ (Built-in incandescent lamp)	
		2	Lamp						
		3	NC	■					
	1NO-1NC (11N1)	1	NC		■		A204F-33E11N1Q③②	5 (6V AC/DC) 6 (12V AC/DC) 7 (24V AC/DC)	
		2	Lamp						
		3	NO			●			

### ■外型尺寸(Dimensions) mm

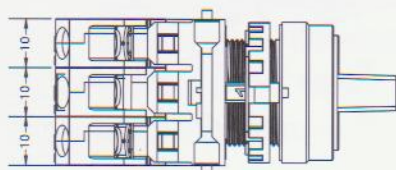

面板厚度 (Panel Thickness)  
0.8~6

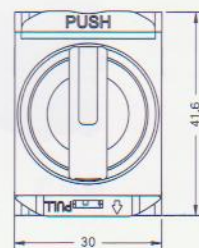
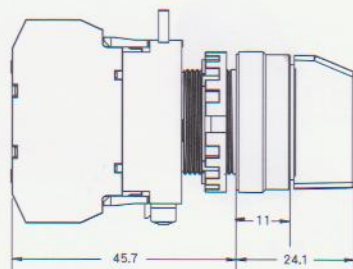

開關構造說明 ( Switch Construction Instructions )

鑰匙選擇開關 ( Key Selector Switches )

A204K

鑰匙選擇開關  
(Key Selector Switches)  
Page.95-100

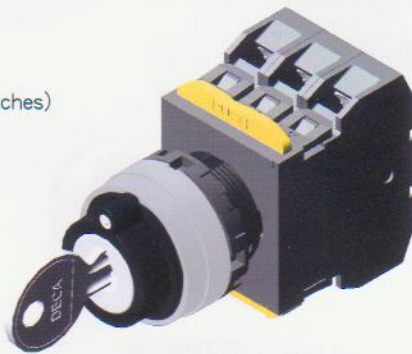

鑰匙選擇開關操作部  
(Key Selector Switches  
Operators)  
Page.105



開關接點部  
( Contact Block  
Assemblies)  
Page.106-107



接點塊安裝轉接器  
(Contact Block  
Mounting Adapter)  
Page.109



接點塊  
(Contact Block)  
Page.108



接點塊  
(Contact Block)  
Page.108



接點塊  
(Contact Block)  
Page.108

鑰匙選擇開關 (Key Selector Switches)

90° -2位置 / 交替型 (90° -2 Position / Maintained)



A204K

位置數 (No. of Positions)	接點結構 (Contacts)			旋鈕位置 (Operator Position)			型號 (Type No.)	使用電壓記號 (Operating Voltage Code)	顏色記號 (Lens Color Code)	
	記號 (Configuration)	位置 (Mounting)	類型 (Position)	L	R	---				
90° -2位置 / 交替型鈕 (90° -2 Position / Maintained)	1NO (10)	1	NO		●		A204K-2E10	無燈泡 (Without Lamp)	僅黑色 (Black only)	
		2								
		3								
	1NC (01)	1								A204K-2E01
		2								
		3	NC	●						
	2NO (20)	1	NO		●		A204K-2E20			
		2								
	2NC (02)	1	NC		●		A204K-2E02			
		2								
		3	NC	●						
	1NO-1NC (11)	1	NO		●		A204K-2E11			
2		NC	●							
3NO (30)	1	NO		●		A204K-2E30				
	2	NO		●						
	3	NO		●						
3NC (03)	1	NC	●			A204K-2E03				
	2	NC	●							
	3	NC	●							
2NO-1NC (21)	1	NO		●		A204K-2E21				
	2	NO		●						
	3	NC	●							
1NO-2NC (12)	1	NO		●		A204K-2E12				
	2	NC	●							
	3	NC	●							

■外型尺寸(Dimensions) mm

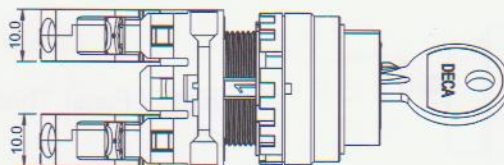

面板厚度 (Panel Thickness)  
0.8~6

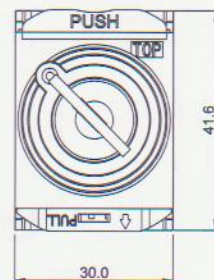
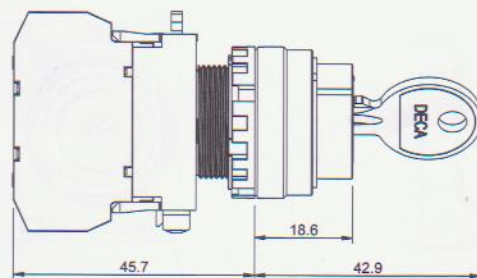

鑰匙選擇開關 (Key Selector Switches)

90° -2位置 / 右復歸型 (90° -2 Position / Spring Return from Right)

A204K

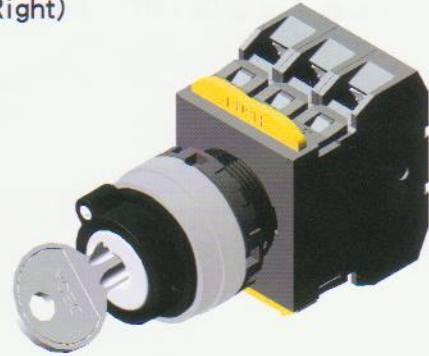

位置數 (No. of Positions)	接點結構 (Contacts)			旋鈕位置 (Operator Position)			型號 (Type No.)	使用電壓記號 (Operating Voltage Code)	顏色記號 (Lens Color Code)	
	記號 (Configuration)	位置 (Mounting)	類型 (Position)	L	R	---				
90° -2位置 / 右復歸型 (90° -2 Position / Spring Return from Right)	1NO (10)	1	NO		●		A204K-21E10	無燈泡 (Without Lamp)	僅黑色 (Black only)	
		2								
		3								
	1NC (01)	1								A204K-21E01
		2			●					
		3	NC	●						
	2NO (20)	1	NO			●	A204K-21E20			
		2				●				
		3	NO			●				
	2NC (02)	1	NC			●	A204K-21E02			
		2			●					
		3	NC	●						
1NO-1NC (11)	1	NO			●	A204K-21E11				
	2			●						
	3	NC	●							
3NO (30)	1	NO			●	A204K-21E30				
	2	NO			●					
	3	NO			●					
3NC (03)	1	NC	●			A204K-21E03				
	2	NC	●							
	3	NC	●							
2NO-1NC (21)	1	NO			●	A204K-21E21				
	2	NO			●					
	3	NC	●							
1NO-2NC (12)	1	NO			●	A204K-21E12				
	2	NC	●							
	3	NC	●							

■外型尺寸(Dimensions) mm

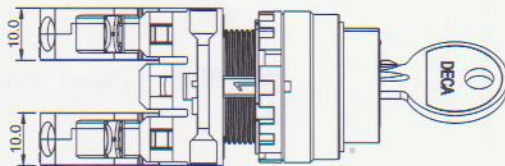

面板厚度 (Panel Thickness)  
0.8~6

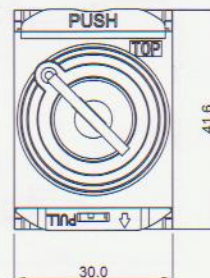
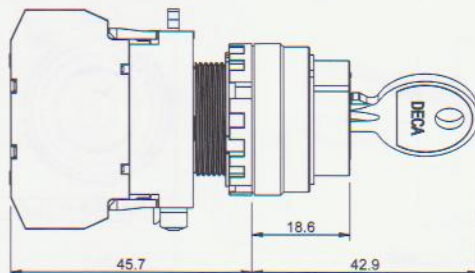



鑰匙選擇開關 (Key Selector Switches)

45° -3位置 / 交替型 (45° -3 Position / Maintained)

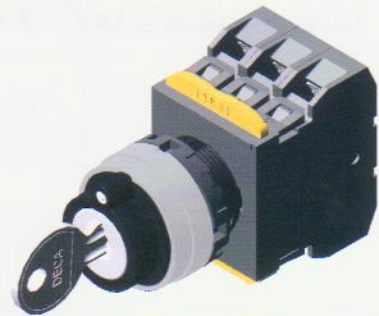

A204K

位置數 (No. of Positions)	接點結構 (Contacts)			旋鈕位置 (Operator Position)			型號 (Type No.)	使用電壓記號 (Operating Voltage Code)	顏色記號 (Lens Color Code)
	記號 (Configuration)	位置 (Mounting)	類型 (Position)	L	C	R			
45° -3位置 / 交替型 (45° -3 Position / Maintained)	2NO (20)	1	NO	●			A204K-3E20	無燈泡 (Without Lamp)	僅黑色 (Black only)
		2							
		3	NO			●			
	2NO (20N1)	1	NO	●			A204K-3E20N1		
		2	NO	●		●			
		3	NO			●			
	2NC (02)	1	NC		■		A204K-3E02		
		2			■				
		3	NC		■				
	2NC (02N1)	1	NC		■	●	A204K-3E02N1		
		2	NC		■	●			
		3	NC		■	●			
	1NO-1NC (11)	1	NO	●			A204K-3E11		
		2							
		3	NC		■				
	1NO-1NC (11N1)	1	NC			■	A204K-3E11N1		
		2							
		3	NO			●			
1NO-1NC (11N2)	1	NO	●			A204K-3E11N2			
	2	NC			■				
	3				●				
1NO-1NC (11N3)	1					A204K-3E11N3			
	2	NC		■					
	3	NO			●				
1NO-1NC (11N4)	1					A204K-3E11N4			
	2	NO	●		●				
	3	NC		■					
3NO (30)	1	NO	●			A204K-3E30			
	2	NO	●		●				
	3	NO			●				
3NC (03)	1	NC		■		A204K-3E03			
	2	NC		■					
	3	NC		■					
2NO-1NC (21)	1	NO	●			A204K-3E21			
	2	NC		■					
	3	NO			●				
1NO-2NC (12)	1	NC		■		A204K-3E12			
	2	NO	●		●				
	3	NC		■					

■外型尺寸(Dimensions) mm

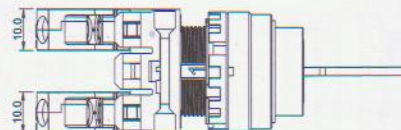

面板厚度 (Panel Thickness)  
0.8~6

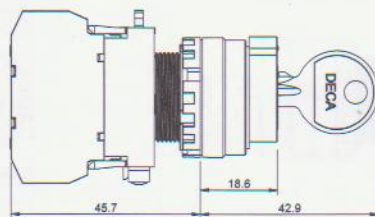

鑰匙選擇開關 (Key Selector Switches)

45° -3位置 / 右復歸型 (45° -3 Position / Spring Return from Right)

A204K

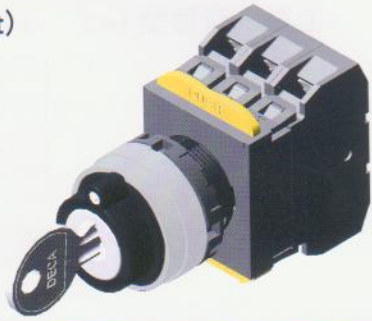

位置數 (No. of Positions)	接點結構 (Contacts)			旋鈕位置 (Operator Position)			型號 (Type No.)	使用電壓記號 (Operating Voltage Code)	顏色記號 (Lens Color Code)	
	記號 (Configuration)	位置 (Mounting)	類型 (Position)	L	C	R				
45° -3位置 / 右復歸型 (45° -3 Position / Spring Return from Right)	2NO (20)	1	NO	●			A204K-31E20	無燈泡 (Without Lamp)	僅黑色 (Black only)	
		2								
		3	NO			●				
	2NO (20N1)	1								A204K-31E20N1
		2	NO	●		●				
		3	NO			●				
	2NC (02)	1	NC		■					A204K-31E02
		2								
		3	NC		■					
	2NC (02N1)	1								A204K-31E02N1
		2	NC		●					
		3	NC		■					
1NO-1NC (11)	1	NO	●				A204K-31E11			
	2									
	3	NC		■						
1NO-1NC (11N1)	1	NC					A204K-31E11N1			
	2									
	3	NO			●					
1NO-1NC (11N2)	1	NO	●				A204K-31E11N2			
	2	NC								
	3				●					
1NO-1NC (11N3)	1						A204K-31E11N3			
	2	NC		●						
	3	NO			●					
1NO-1NC (11N4)	1						A204K-31E11N4			
	2	NO	●		●					
	3	NC		■						
3NO (30)	1	NO	●				A204K-31E30			
	2	NO	●		●					
	3	NO			●					
3NC (03)	1	NC					A204K-31E03			
	2	NC		●						
	3	NC		■						
2NO-1NC (21)	1	NO	●				A204K-31E21			
	2	NC		●						
	3	NO			●					
1NO-2NC (12)	1	NC					A204K-31E12			
	2	NO	●		●					
	3	NC		■						

■外型尺寸(Dimensions) mm

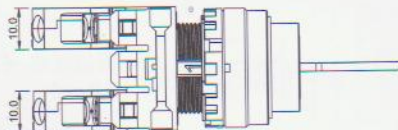

面板厚度 (Panel Thickness)  
0.8~6

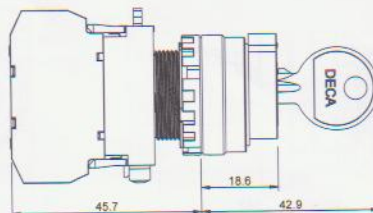

鑰匙選擇開關 (Key Selector Switches)

45° -3位置 / 左復歸型 (45° -3 Position / Spring Return from Left)

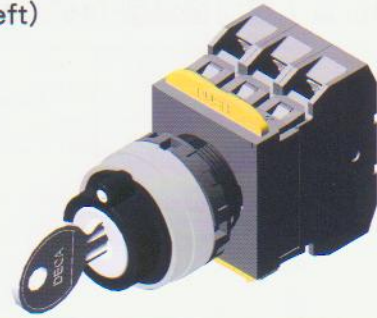

A204K

位置數 (No. of Positions)	接點結構 (Contacts)			旋鈕位置 (Operator Position)			型號 (Type No.)	使用電壓記號 (Operating Voltage Code)	顏色記號 (Lens Color Code)
	記號 (Configuration)	位置 (Mounting)	類型 (Position)	L	C	R			
2NO (20)		1	NO	●			A204K-32E20		
		2							
		3	NO			●			
2NO (20N1)		1					A204K-32E20N1		
		2	NO	●		●			
		3	NO			●			
2NC (02)		1	NC		■		A204K-32E02		
		2							
		3	NC	■					
2NC (02N1)		1					A204K-32E02N1		
		2	NC		●				
		3	NC	■					
1NO-1NC (11)		1	NO	●			A204K-32E11		
		2							
		3	NC	■					
45° -3位置 / 左復歸型 (45° -3 Position / Spring Return from Left)		1	NC		■		A204K-32E11N1		
		2							
		3	NO			●			
1NO-1NC (11N2)		1	NO	●			A204K-32E11N2	無燈泡 (Without Lamp)	僅黑色 (Black only)
		2	NC			●			
		3							
L C R ↙ ↓ ↘		1	NC		●		A204K-32E11N3		
		2							
		3	NO			●			
1NO-1NC (11N4)		1					A204K-32E11N4		
		2	NO	●		●			
		3	NC	■					
3NO (30)		1	NO	●			A204K-32E30		
		2	NO	●		●			
		3	NO			●			
3NC (03)		1	NC		■		A204K-32E03		
		2	NC		●				
		3	NC	■					
2NO-1NC (21)		1	NO	●			A204K-32E21		
		2	NC		●				
		3	NO			●			
1NO-2NC (12)		1	NC		■		A204K-32E12		
		2	NO	●		●			
		3	NC	■					

■外型尺寸(Dimensions) mm

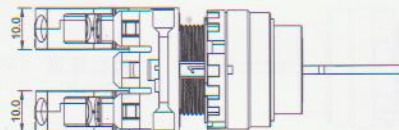

面板厚度 (Panel Thickness)  
0.8~6

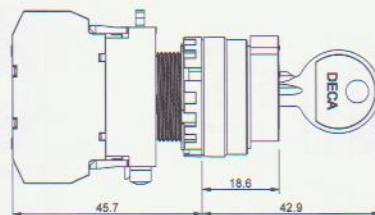

鑰匙選擇開關 (Key Selector Switches)

45° -3位置 / 雙向復歸型 (45° -3 Position / Spring Return from Two-Way)

A204K



位置數 (No. of Positions)	接點結構 (Contacts)			旋鈕位置 (Operator Position)			型號 (Type No.)	使用電壓記號 (Operating Voltage Code)	顏色記號 (Lens Color Code)	
	記號 (Configuration)	位置 (Mounting)	類型 (Position)	L	C	R				
45° -3位置 雙向復歸型 (45° -3 Position / Spring Return from Two-Way)	2NO (20)	1	NO	●			A204K-33E20	無燈泡 (Without Lamp)	僅黑色 (Black only)	
		2								
		3	NO			●				
	2NO (20N1)	1								A204K-33E20N1
		2	NO	●		●				
		3	NO			●				
	2NC (02)	1	NC		■					A204K-33E02
		2								
		3	NC		■					
	2NC (02N1)	1								A204K-33E02N1
		2	NC		●					
		3	NC		■					
	1NO-1NC (11)	1	NO	●						A204K-33E11
		2								
		3	NC		■					
	1NO-1NC (11N1)	1	NC			■				A204K-33E11N1
		2								
		3	NO			●				
1NO-1NC (11N2)	1	NO	●				A204K-33E11N2			
	2	NC				●				
	3									
1NO-1NC (11N3)	1						A204K-33E11N3			
	2	NC		●						
	3	NO			●					
1NO-1NC (11N4)	1						A204K-33E11N4			
	2	NO	●			●				
	3	NC		■						
3NO (30)	1	NO	●				A204K-33E30			
	2	NO	●			●				
	3	NO				●				
3NC (03)	1	NC			■		A204K-33E03			
	2	NC		●						
	3	NC		■						
2NO-1NC (21)	1	NO	●				A204K-33E21			
	2	NC		●						
	3	NO			●					
1NO-2NC (12)	1	NC			■		A204K-33E12			
	2	NO	●			●				
	3	NC		■						

■外型尺寸(Dimensions) mm

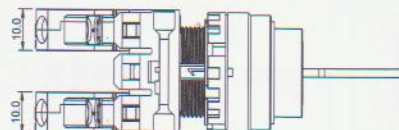



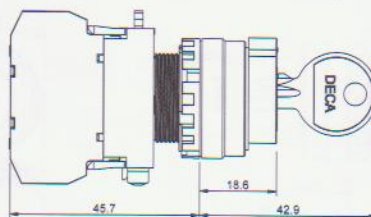

面板厚度 (Panel Thickness)  
0.8~6



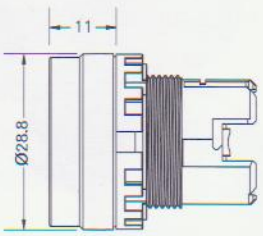

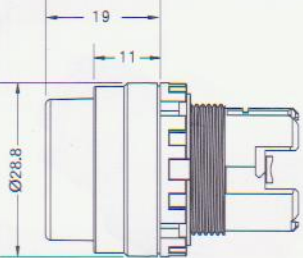

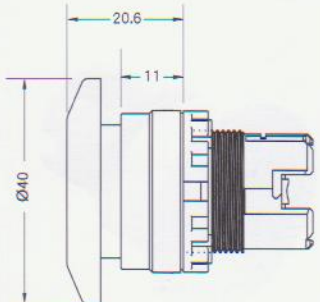
按鈕開關操作部 (Pushbutton Operators)

操作部

名稱 / 外觀 (Style)	動作類型 (Operation)	型號 (Type No.)	顏色 (Lens Color)	頭部尺寸 (Dimensions) Unit : mm
<p>平頭形 (Flush)</p> 	<p>瞬時型 (Momentary)</p>	A204B-M1EB	黑色 (black)	
		A204B-M1EG	綠色 (green)	
		A204B-M1ER	紅色 (red)	
		A204B-M1ES	藍色 (blue)	
		A204B-M1EW	白色 (white)	
		A204B-M1EY	黃色 (yellow)	
	<p>交替型 (Maintained)</p>	A204B-A1EB	黑色 (black)	
		A204B-A1EG	綠色 (green)	
		A204B-A1ER	紅色 (red)	
		A204B-A1ES	藍色 (blue)	
		A204B-A1EW	白色 (white)	
		A204B-A1EY	黃色 (yellow)	
<p>凸頭形 (Extended)</p> 	<p>瞬時型 (Momentary)</p>	A204B-M2EB	黑色 (black)	
		A204B-M2EG	綠色 (green)	
		A204B-M2ER	紅色 (red)	
		A204B-M2ES	藍色 (blue)	
		A204B-M2EW	白色 (white)	
		A204B-M2EY	黃色 (yellow)	
	<p>交替型 (Maintained)</p>	A204B-A2EB	黑色 (black)	
		A204B-A2EG	綠色 (green)	
		A204B-A2ER	紅色 (red)	
		A204B-A2ES	藍色 (blue)	
		A204B-A2EW	白色 (white)	
		A204B-A2EY	黃色 (yellow)	
<p>φ 40mm 蘑菇頭形 (Mushroom φ 40mm)</p> 	<p>瞬時型 (Momentary)</p>	A204B-M4EB	黑色 (black)	
		A204B-M4EG	綠色 (green)	
		A204B-M4ER	紅色 (red)	
		A204B-M4ES	藍色 (blue)	
		A204B-M4EW	白色 (white)	
		A204B-M4EY	黃色 (yellow)	
	<p>交替型 (Maintained)</p>	A204B-A4EB	黑色 (black)	
		A204B-A4EG	綠色 (green)	
		A204B-A4ER	紅色 (red)	
		A204B-A4ES	藍色 (blue)	
		A204B-A4EW	白色 (white)	
		A204B-A4EY	黃色 (yellow)	

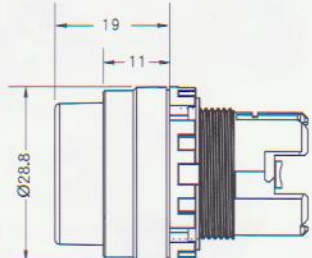

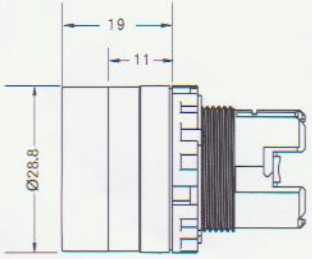
照光按鈕開關操作部 (Illuminated Pushbutton Operators)

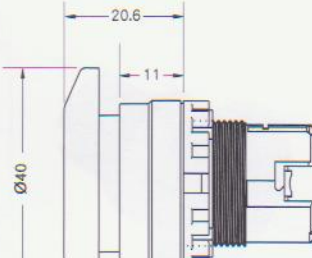
操作部

名稱 / 外觀 (Style)	動作類型 (Operation)	型號 (Type No.)	顏色 (Lens Color)	頭部尺寸 (Dimensions) Unit : mm
 <p>圓形凸頭 (Extended)</p>	<p>瞬時型 (Momentary)</p>	A204L-M2EA	琥珀色 (amber)	
		A204L-M2EC	透明 (clear)	
		A204L-M2EG	綠色 (green)	
		A204L-M2EPW	純白色 (pure white)	
		A204L-M2ER	紅色 (red)	
		A204L-M2ES	藍色 (blue)	
		A204L-M2EW	乳白色 (white)	
	A204L-M2EY	黃色 (yellow)		
	<p>交替型 (Maintained)</p>	A204L-A2EA	琥珀色 (amber)	
		A204L-A2EC	透明 (clear)	
		A204L-A2EG	綠色 (green)	
		A204L-A2EPW	純白色 (pure white)	
		A204L-A2ER	紅色 (red)	
		A204L-A2ES	藍色 (blue)	
A204L-A2EW		乳白色 (white)		
A204L-A2EY	黃色 (yellow)			
 <p>全護圍圓形凸頭 (Extended with Full Shroud)</p>	<p>瞬時型 (Momentary)</p>	A204L-MF2EA	琥珀色 (amber)	
		A204L-MF2EC	透明 (clear)	
		A204L-MF2EG	綠色 (green)	
		A204L-MF2EPW	純白色 (pure white)	
		A204L-MF2ER	紅色 (red)	
		A204L-MF2ES	藍色 (blue)	
		A204L-MF2EW	乳白色 (white)	
	A204L-MF2EY	黃色 (yellow)		
	<p>交替型 (Maintained)</p>	A204L-AF2EA	琥珀色 (amber)	
		A204L-AF2EC	透明 (clear)	
		A204L-AF2EG	綠色 (green)	
		A204L-AF2EPW	純白色 (pure white)	
		A204L-AF2ER	紅色 (red)	
		A204L-AF2ES	藍色 (blue)	
A204L-AF2EW		乳白色 (white)		
A204L-AF2EY	黃色 (yellow)			
 <p>φ 40mm 蘑菇頭形 (Mushroom φ 40mm)</p>	<p>瞬時型 (Momentary)</p>	A204L-M4EA	琥珀色 (amber)	
		A204L-M4EC	透明 (clear)	
		A204L-M4EG	綠色 (green)	
		A204L-M4EPW	純白色 (pure white)	
		A204L-M4ER	紅色 (red)	
		A204L-M4ES	藍色 (blue)	
		A204L-M4EW	乳白色 (white)	
	A204L-M4EY	黃色 (yellow)		
	<p>交替型 (Maintained)</p>	A204L-A4EA	琥珀色 (amber)	
		A204L-A4EC	透明 (clear)	
		A204L-A4EG	綠色 (green)	
		A204L-A4EPW	純白色 (pure white)	
		A204L-A4ER	紅色 (red)	
		A204L-A4ES	藍色 (blue)	
A204L-A4EW		乳白色 (white)		
A204L-A4EY	黃色 (yellow)			

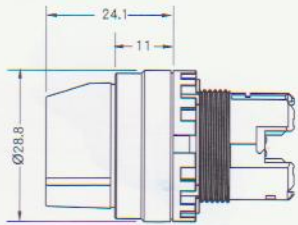

選擇開關操作部 ( Selector Switches Operators )

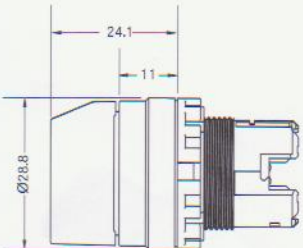
操作部

名稱 / 外觀 (Style)	動作類型 (Operation)	型號 (Type No.)	顏色 (Lens Color)	頭部尺寸 (Dimensions) Unit : mm
 <p>90° -2位置 / 標準旋鈕 (90° -2 Position / Knob Type)</p>	交替型 (Maintained)	A204S-2E	黑色 (black)	
		A204S-2EG	綠色 (green)	
		A204S-2ER	紅色 (red)	
		A204S-2ES	藍色 (blue)	
		A204S-2EW	白色 (white)	
		A204S-2EY	黃色 (yellow)	
	右復歸型 (Spring Return from Right)	A204S-21E	黑色 (black)	
		A204S-21EG	綠色 (green)	
		A204S-21ER	紅色 (red)	
		A204S-21ES	藍色 (blue)	
		A204S-21EW	白色 (white)	
		A204S-21EY	黃色 (yellow)	
 <p>45° -3位置 / 標準旋鈕 (45° -3 Position / Knob Type)</p>	交替型 (Maintained)	A204S-3E	黑色 (black)	
		A204S-3EG	綠色 (green)	
		A204S-3ER	紅色 (red)	
		A204S-3ES	藍色 (blue)	
		A204S-3EW	白色 (white)	
		A204S-3EY	黃色 (yellow)	
	右復歸型 (Spring Return from Right)	A204S-31E	黑色 (black)	
		A204S-31EG	綠色 (green)	
		A204S-31ER	紅色 (red)	
		A204S-31ES	藍色 (blue)	
		A204S-31EW	白色 (white)	
		A204S-31EY	黃色 (yellow)	
	左復歸型 (Spring Return from Left)	A204S-32E	黑色 (black)	
		A204S-32EG	綠色 (green)	
		A204S-32ER	紅色 (red)	
		A204S-32ES	藍色 (blue)	
		A204S-32EW	白色 (white)	
		A204S-32EY	黃色 (yellow)	
	雙向復歸型 (Spring Return from Tow-Way)	A204S-33E	黑色 (black)	
		A204S-33EG	綠色 (green)	
		A204S-33ER	紅色 (red)	
		A204S-33ES	藍色 (blue)	
		A204S-33EW	白色 (white)	
		A204S-33EY	黃色 (yellow)	

照光選擇開關操作部 (Illuminated Selector Switches Operators)

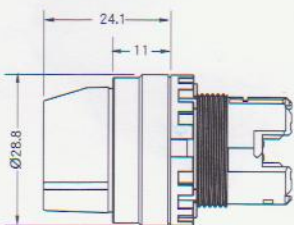

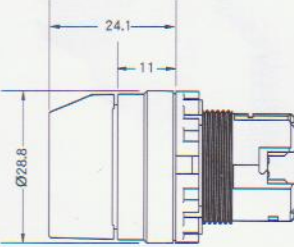
操作部

名稱 / 外觀 (Style)	動作類型 (Operation)	型號 (Type No.)	顏色 (Lens Color)	頭部尺寸 (Dimensions) Unit : mm			
90° -2位置 / 標準旋鈕 (90° -2 Position / Knob Type)  	交替型 (Maintained)	A204F-2EA	琥珀色 (amber)				
		A204F-2EG	綠色 (green)				
		A204F-2ER	紅色 (red)				
		A204F-2ES	藍色 (blue)				
		A204F-2EW	白色 (white)				
		A204F-2EY	黃色 (yellow)				
	右復歸型 (Spring Return from Right)	A204F-21EA	琥珀色 (amber)				
		A204F-21EG	綠色 (green)				
		A204F-21ER	紅色 (red)				
		A204F-21ES	藍色 (blue)				
		A204F-21EW	白色 (white)				
		A204F-21EY	黃色 (yellow)				
		45° -3位置 / 標準旋鈕 (45° -3 Position / Knob Type)  	交替型 (Maintained)		A204F-3EA	琥珀色 (amber)	
					A204F-3EG	綠色 (green)	
A204F-3ER	紅色 (red)						
A204F-3ES	藍色 (blue)						
A204F-3EW	白色 (white)						
A204F-3EY	黃色 (yellow)						
右復歸型 (Spring Return from Right)	A204F-31EA		琥珀色 (amber)				
	A204F-31EG		綠色 (green)				
	A204F-31ER		紅色 (red)				
	A204F-31ES		藍色 (blue)				
	A204F-31EW		白色 (white)				
	A204F-31EY		黃色 (yellow)				
左復歸型 (Spring Return from Left)	A204F-32EA	琥珀色 (amber)					
	A204F-32EG	綠色 (green)					
	A204F-32ER	紅色 (red)					
	A204F-32ES	藍色 (blue)					
	A204F-32EW	白色 (white)					
	A204F-32EY	黃色 (yellow)					
雙向復歸型 (Spring Return from Tow-Way)	A204F-33EA	琥珀色 (amber)					
	A204F-33EG	綠色 (green)					
	A204F-33ER	紅色 (red)					
	A204F-33ES	藍色 (blue)					
	A204F-33EW	白色 (white)					
	A204F-33EY	黃色 (yellow)					

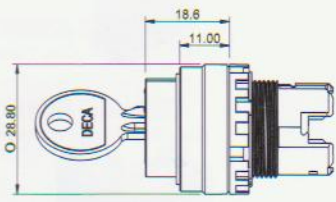

鑰匙選擇開關操作部 (Key Selector Operators)

操作部

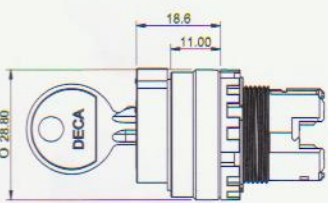
名稱 / 外觀 (Style)	動作類型 (Operation)	型號 (Type No.)	顏色 (Lens Color)	頭部尺寸 (Dimensions) Unit : mm
90° -2位置 / 標準旋鈕 (90° -2 Position / Knob Type)  	交替型 (Maintained)	A204K-2E	僅黑色 (Black only)	
	右復歸型 (Spring Return from Right)	A204K-21E		
45° -3位置 / 標準旋鈕 (45° -3 Position / Knob Type)  	交替型 (Maintained)	A204K-3E	僅黑色 (Black only)	
	右復歸型 (Spring Return from Right)	A204K-31E		
	左復歸型 (Spring Return from Left)	A204K-32E		
	雙向復歸型 (Spring Return from Tow-Way)	A204K-33E		

開關接點部 (Contact Block Assemblies)

接點部



名稱 / 外觀 (Style)	燈座類型 (Lamp Socket)	型號 (Type No.)	接點結構 (Contacts)			尺寸 (Dimensions) Unit : mm
			記號 (Configuration)	位置 (Mounting)	類型 (Position)	
1個 接點塊 (1 Contact Block)	無 (WithOut)	A20B-E10P	1NO (10)	1	NO	
		A20B-E01P	1NC (01)	2		
	BA9s 全電壓型 (Full Voltage)	A20L-E10P	1NO (10)	1	NO	
		A20L-E01P	1NC (01)	2	NC	
2個 接點塊 (2 Contact Blocks)	無 (WithOut)	A20B-E20P	2NO (20)	1	NO	
		A20B-E02P	2NC (02)	2	NC	
		A20B-E11P	1NO-1NC (11)	3	NC	
	BA9s 全電壓型 (Full Voltage)	A20L-E20P	2NO (20)	1	NO	
		A20L-E02P	2NC (02)	2	Lamp	
		A20L-E11P	1NO-1NC (11)	3	NC	
		A20L-E20P	2NO (20)	1	NO	
		A20L-E02P	2NC (02)	2	Lamp	
		A20L-E11P	1NO-1NC (11)	3	NC	

開關接點部 (Contact Block Assemblies)





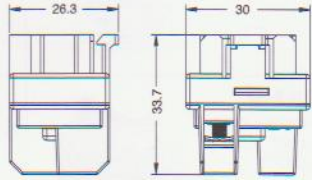

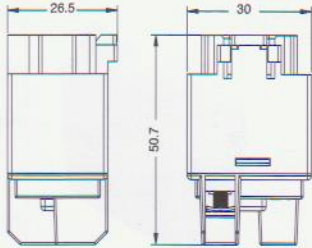





名稱 / 外觀 (Style)	燈座類型 (Lamp Socket)	型號 (Type No.)	接點結構 (Contacts)			尺寸 (Dimensions) Unit : mm	
			記號 (Configuration)	位置 (Mounting)	類型 (Position)		
3個 接點塊 (3 Contact Block)		無 (WithOut)	A20B-E30P	3NO (30)	1 2 3	NO NO NO	
			A20B-E03P	3NC (03)	1 2 3	NC NC NC	
			A20B-E21P	2NO-1NC (21)	1 2 3	NO NO NC	
			A20B-E12P	1NO-2NC (12)	1 2 3	NO NC NC	

轉接器

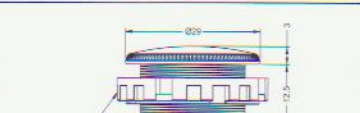
指示燈轉接器 (Pilot Lights Adapter)

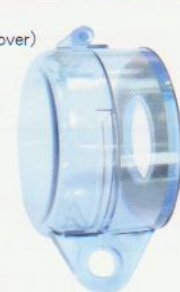
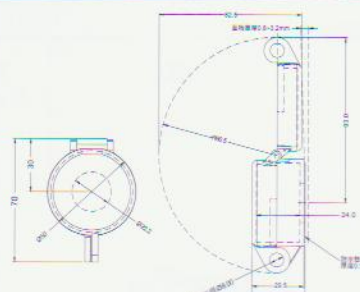

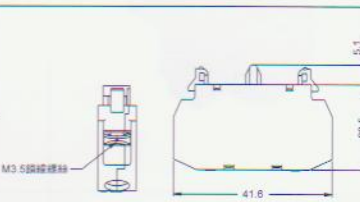
名稱 / 外觀 (Style)	燈座類型 (Lamp Socket)	動作電壓 (Operating Voltage)	型號 (Type No.)	尺寸 (Dimensions) Unit : mm
全電壓型 (Full Voltage)	BA9s	最大(max.) 250V AC/DC	A20-EQ	
				
變壓器型 (Transformer Type)	BA9s 適用燈泡額定值 6V AC/DC (Applicable Lamp Rating)	100/110V AC	A20-EH	
		200/220V AC	A20-EM	
		115/120V AC	A20-EH2	
		230/240V AC	A20-EM4	

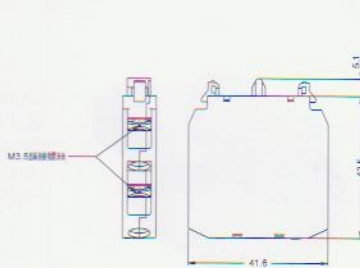
## 附件 (Accessories)



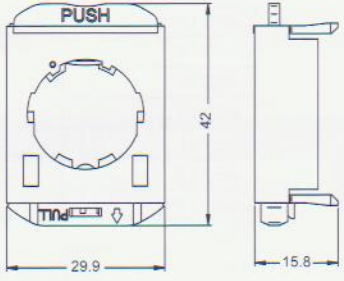

名稱 / 外觀 (Name / Shape)	型號 (Type No.)	說明 (Description)	外型尺寸圖 (Dimensions) Unit : mm
鎖緊環扳手 (Locking Ring Wrench) 	A29Z-T1	A20系列控制元件安裝到面板時,緊固鎖緊環用 (Metallic tool used to tighten the plastic locking ring when installing the A20 series control unit on a panel)	
燈泡更換工具 (Lamp Holder Tool) 	A20R-55	安裝及拆卸燈泡用 (Made of rubber Used for replacing lamps)	
安裝孔塞 (Rubber Mounting Hole Plug) 	A20B-31	遮掩預備安裝孔用。 顏色：黑 (Used for plugging unused mounting holes in the panel. Color : Black)	
金屬安裝孔塞 (Metallic Mounting Hole Plug) 	A29Z-BM	遮掩預備安裝孔用。 重量：約 18g (Used for plugging unused mounting holes in the panel. Weight : Approx. 18g)	
防轉環 (Anti-Rotation Ring) 	A29Z-RL	防止操作旋扭轉動。 保護結構：IP65 適用面板厚度：1.2-4.5 mm  (Prevents rotation of switches in panel. Degree of protection : IP65. Applicable panel thickness : 1.2-4.5 mm)	
鎖扣罩 (Padlock Cover) 	A29Z-KL1	用於按鈕開關 / 照光按鈕開關與選擇開關的安全性保護。 保護結構：IP65 適用面板厚度：0.8-3.2 mm  (Plastic hinged cover to protect pushbuttons / illuminated pushbuttons, or selector switches. Degree of protection : IP65. Applicable panel thickness : 1.2-4.5 mm)	
單接點塊 (Single Contact Block) 	A20-E10P	接點：1NO	
	A20-E01P	接點：1NC	
雙接點塊 (Double Contact Block) 	A20-E20P	接點：2NO	
	A20-E11P	接點：1NO-1NO	
	A20-E02P	接點：2NC	

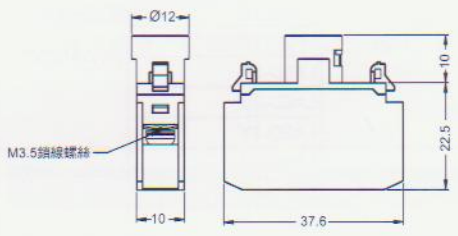
## 附件 (Accessories)

附件

名稱 / 外觀 (Name / Shape)	型號 (Type No.)	外型尺寸圖 (Dimensions) Unit : mm
<p>接點塊安裝轉接器 (Mounting Collar) (Contact Block Mounting Adapter)</p> 	<p>A20B-E00P</p>	
<p>全電壓轉接器 (Lamp Socket)(Full Voltage Adapter)</p> 	<p>A20-E00P</p>	

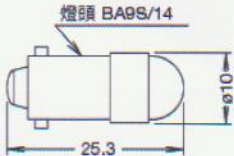
## 附件 (Accessories)

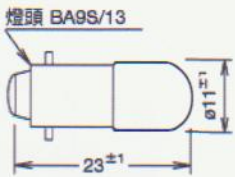
名稱 / 外觀 (Name / Shape)	型號 (Type No.)	說明 (Description)	外型尺寸圖 (Dimensions) mm
LED Lamp 燈頭 BA9s/14 (Base) 	LAED-6A	琥珀色 (amber)	 <p>指示燈和照光按鈕開關的白色照光使用黃色 LED 燈泡 (Yellow LED lamps are used for white illumination of pilot lights and illuminated pushbuttons)</p>
	LAED-6G	綠色 (green)	
	LAED-6PW	純白色 (pure white)	
	LAED-6R	紅色 (red)	
	LAED-6S	藍色 (blue)	
	LAED-6Y	黃色 (yellow)	
	LAED-1A	琥珀色 (amber)	
	LAED-1G	綠色 (green)	
	LAED-1PW	純白色 (pure white)	
	LAED-1R	紅色 (red)	
	LAED-1S	藍色 (blue)	
	LAED-1Y	黃色 (yellow)	
	LAED-2A	琥珀色 (amber)	
	LAED-2G	綠色 (green)	
	LAED-2PW	純白色 (pure white)	
	LAED-2R	紅色 (red)	
	LAED-2S	藍色 (blue)	
	LAED-2Y	黃色 (yellow)	
LED Lamp 燈頭 BA9s/14 (Base) 	LAED-HA	琥珀色 (amber)	 <p>指示燈和照光按鈕開關的白色照光使用黃色 LED 燈泡 (Yellow LED lamps are used for white illumination of pilot lights and illuminated pushbuttons)</p>
	LAED-HG	綠色 (green)	
	LAED-HPW	純白色 (pure white)	
	LAED-HR	紅色 (red)	
	LAED-HS	藍色 (blue)	
	LAED-HY	黃色 (yellow)	
	LAED-M3A	琥珀色 (amber)	
	LAED-M3G	綠色 (green)	
	LAED-M3PW	純白色 (pure white)	
	LAED-M3R	紅色 (red)	
	LAED-M3S	藍色 (blue)	
	LAED-M3Y	黃色 (yellow)	
白熾燈泡 (Incandescent Lamp) 燈頭 BA9s/13 (Base) 	LA-T6P	6.3V 1W	
	LA-T8P	18V 1W	
	LA-T3P	30V 1W	

## 附件 (Accessories)

附件



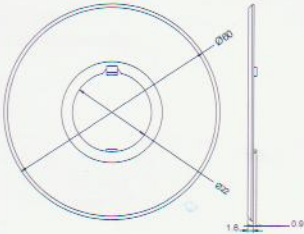

名稱 (Name)	外觀 (Style)	型號 (Type No.)	顏色 (Color)	外型尺寸圖 (Dimensions) mm
按鈕 (Button) 用於按鈕開關 (for pushbuttons)	凸頭形 (Extended)	A29Z-B12B	黑色 (black)	
		A29Z-B12G	綠色 (green)	
		A29Z-B12R	紅色 (red)	
		A29Z-B12S	藍色 (blue)	
		A29Z-B12W	白色 (white)	
		A29Z-B12Y	黃色 (yellow)	
	φ 40mm 蘑菇頭形 (Mushroom φ 40mm)	A29Z-B14B	黑色 (black)	
		A29Z-B14G	綠色 (green)	
		A29Z-B14R	紅色 (red)	
		A29Z-B14S	藍色 (blue)	
		A29Z-B14W	白色 (white)	
		A29Z-B14Y	黃色 (yellow)	
燈罩 (Lens) 用於指示燈 (for pilot lights)	平頭形 (Flush)	A29Z-PL11A	琥珀色 (amber)	
		A29Z-PL11C	透明 (clear)	
		A29Z-PL11G	綠色 (green)	
		A29Z-PL11R	紅色 (red)	
		A29Z-PL11S	藍色 (blue)	
		A29Z-PL11W	乳白色 (white)	
		A29Z-PL11Y	黃色 (yellow)	
		平頭形(記名式) (Flush Marking Type)	A29Z-PL11BA	
	A29Z-PL11BC		透明 (clear)	
	A29Z-PL11BG		綠色 (green)	
	A29Z-PL11BR		紅色 (red)	
	A29Z-PL11BS		藍色 (blue)	
	A29Z-PL11BW		乳白色 (white)	
	A29Z-PL11BY		黃色 (yellow)	
	凸頭形 (Extended)		A29Z-PL12TA	琥珀色 (amber)
		A29Z-PL12TC	透明 (clear)	
		A29Z-PL12TG	綠色 (green)	
		A29Z-PL12TR	紅色 (red)	
		A29Z-PL12TS	藍色 (blue)	
		A29Z-PL12TW	乳白色 (white)	
		A29Z-PL12TY	黃色 (yellow)	
		半球形 (Dome)	A29Z-PL12A	琥珀色 (amber)
	A29Z-PL12C		透明 (clear)	
	A29Z-PL12G		綠色 (green)	
A29Z-PL12R	紅色 (red)			
A29Z-PL12S	藍色 (blue)			
A29Z-PL12W	乳白色 (white)			
A29Z-PL12Y	黃色 (yellow)			
燈罩 (Lens) 用於照光按鈕開關 (for illuminated pushbuttons)	圓形凸頭 (Extended)		A29Z-L12TA	琥珀色 (amber)
		A29Z-L12TC	透明 (clear)	
		A29Z-L12TG	綠色 (green)	
		A29Z-L12TR	紅色 (red)	
		A29Z-L12TS	藍色 (blue)	
		A29Z-L12TY	黃色 (yellow)	
	φ 40mm 蘑菇頭形 (Mushroom φ 40mm)	A29Z-L14TA	琥珀色 (amber)	
		A29Z-L14TC	透明 (clear)	
		A29Z-L14TG	綠色 (green)	
		A29Z-L14TR	紅色 (red)	
		A29Z-L14TS	藍色 (blue)	
		A29Z-L14TY	黃色 (yellow)	
記名板 (Marking Plate)	用於指示燈 (for pilot lights)	A29Z-PP12		
	用於照光按鈕開關 (for illuminated pushbuttons)	A29Z-P12		

## 附件 (Accessories)

附件

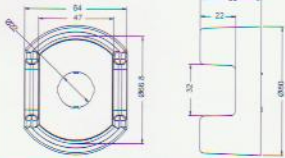
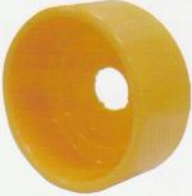
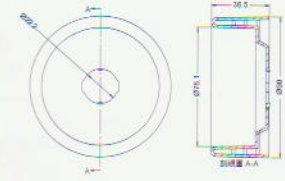
外觀 (Shape)	型號 / 文字記名 (Type No. / Legend)	說明 (Description)	外型尺寸圖 (Dimensions) Unit : mm
	A2AV-0 無 (Blank)	用於 $\phi 40\text{mm}$ 蘑菇頭形緊急停止開關, 與 $\phi 40\text{mm}$ 蘑菇頭形照光緊急停止開關  (for Mushroom $\phi 40\text{mm}$ Type with Emergency Stop Switches or Mushroom $\phi 40\text{mm}$ Type with Illuminated Emergency Stop Switches)  材質: PA6 (Material) 顏色: 黃 (Color: Yellow) 保護結構: IP65 (Degree of protection) 1.5mm厚 (thick)	
	A2AV-27 EMERGENCY STOP		
	A2AV-C27 緊急停止		
	A2AV-E27 NOT-NUS		

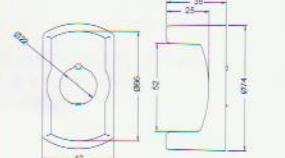
### EMO 開關保護裝置 (EMO Switch Guards)

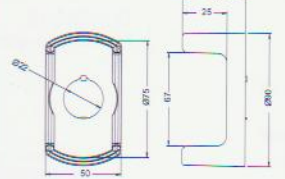
外觀 (Shape)	型號 (Type No.)	說明 (Description)	外型尺寸圖 (Dimensions) Unit : mm
	A29Z-KG1 符合 SEMI S2 標準 (SEMI S2 compliant)	用於 $\phi 40\text{mm}$ 蘑菇頭形緊急停止開關, 與 $\phi 40\text{mm}$ 蘑菇頭形照光緊急停止開關  (for Mushroom $\phi 40\text{mm}$ Type with Emergency Stop Switches or Mushroom $\phi 40\text{mm}$ Type with Illuminated Emergency Stop Switches)  材質: PA6 (Material) 顏色: 黃 (Color: Yellow) 保護結構: IP65 (Degree of protection)	
	A29Z-KG2 符合 SEMI S2 標準 (SEMI S2 compliant) 符合 SEMATECH 標準 (SEMATECH compliant)		
	A29Z-KG3 符合 SEMI S2 標準 (SEMI S2 compliant)		
	A29Z-KG4 符合 SEMI S2 標準 (SEMI S2 compliant) 符合 SEMATECH 標準 (SEMATECH compliant)		



# Ø22 A20 系列控制元件

## 配線盒

型號 (Type No.)	外觀 (Shape)	說明 (Description)	外型尺寸圖 (Dimensions) Unit: mm
AB1T-000Z		蓋子顏色: 米白 安裝孔數: 無	
AB1W-111Y		蓋子顏色: 黃 安裝孔數: 1 孔徑: $\phi 22.3\text{mm}$	
AB1W-111Z		蓋子顏色: 米白 安裝孔數: 1 孔徑: $\phi 22.3\text{mm}$	
AB2T-000Z		蓋子顏色: 米白 安裝孔數: 無	
AB2W-211Z		蓋子顏色: 米白 安裝孔數: 2 孔徑: $\phi 22.3\text{mm}$ 孔距: 50mm	
AB2W-312Z		蓋子顏色: 米白 安裝孔數: 3 孔徑: $\phi 22.3\text{mm}$ 孔距: 30mm	
AB3T-000Z		蓋子顏色: 米白 安裝孔數: 無	
AB3W-311Z		蓋子顏色: 米白 安裝孔數: 3 孔徑: $\phi 22.3\text{mm}$ 孔距: 50mm	
AB3W-413Z		蓋子顏色: 米白 安裝孔數: 4 孔徑: $\phi 22.3\text{mm}$ 孔距: 36mm	
AB3W-512Z		蓋子顏色: 米白 安裝孔數: 5 孔徑: $\phi 22.3\text{mm}$ 孔距: 30mm	

附件

## 安全注意事項

### ◆作業前需切斷電源

在進行安裝 / 拆卸 / 配線 / 保養 (維護) 之前, 務必將電源切斷; 否則有發生觸電 / 燒傷及火災的危險。

### ◆通電時勿靠近帶電部位

在通電狀況下請勿進行配線, 並且要避免在通電時接觸或接近帶電部位; 否則有發生觸電 / 燒傷及火災的危險。

### ◆依規定使用安裝之配件與條件

控制元件之電源可用範圍, 請參考“接點容量”表。  
配線使用之電線必須與所用電壓 / 電流相符合。  
接線螺絲必須依建議扭力值鎖緊, 太鬆 / 太緊皆不適宜。

## 使用注意事項

### ◆面板安裝注意事項

安裝孔尺寸圖 (mm)

面板厚度 0.8-6mm  
(包含表面處理膜厚)

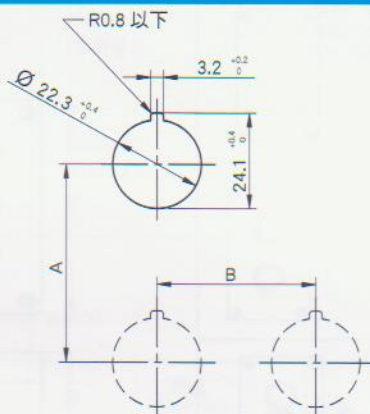

元件	A(mm)	B(mm)
緊急停止開關	50以上	50以上
按鈕	50以上	30以上
選擇開關	50以上	40以上
指示燈	30以上*	30以上

\*使用功率大於1W的燈泡時, 應保留至少50mm的間距。

### ◆開關操作部與接點部的拆卸及安裝

#### 1. 拆卸接點部

a. 如下圖所示手指壓下鎖扣板 (黃色) PUSH端, 並將接點部順著指示方向拉出, 脫離操作部。

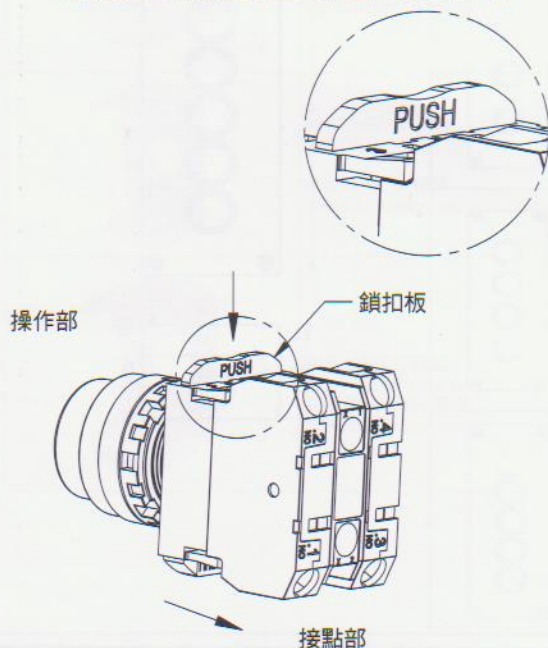

b. 密集安裝時; 如下圖所示, 使用一字型起子 (寬5mm以下), 插入鎖扣板 (黃色) PULL端的一字型孔中, 依指示方向施力使鎖扣板到達脫離位置, 並將接點部順著指示方向拉出, 脫離操作部。

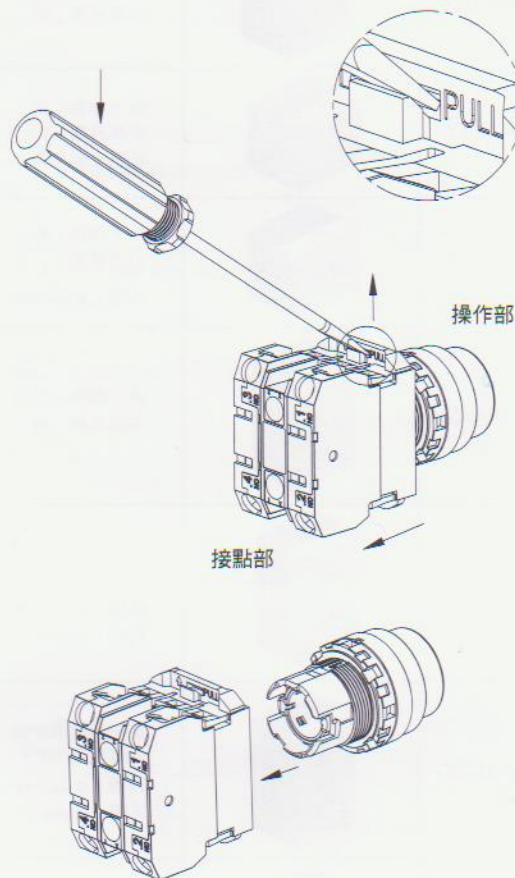

#### 2. 安裝接點部

將接點部有“TOP”標示的一邊, 與操作部有“TOP”標示的一邊對齊後強制插入即可 (裝置內之彈簧機構自動使鎖扣板卡至定位)。

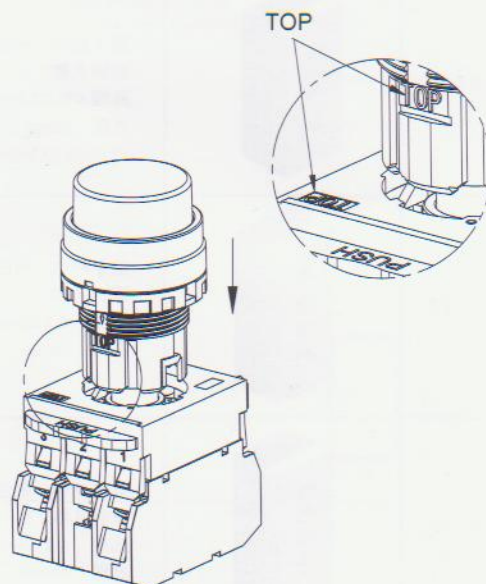

## ◆指示燈照光部與轉接器的拆卸及安裝

- ①如下圖所示，使用一字型起子（寬5mm以下），插入轉接器的一字型孔中，依指示方向施力使轉接器卡鉤到達脫離位置，並將轉接器順著指示方向拉出，脫離照光部。

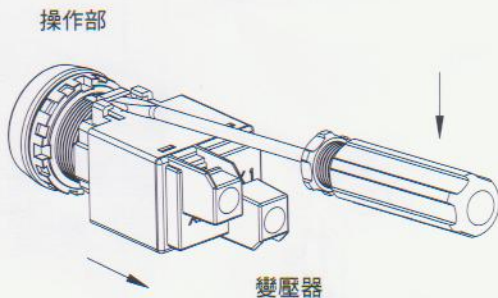

- ②安裝時將轉接器有“TOP”標示的一邊，與照光部有“TOP”標示的一邊對齊後插入即可。

## ◆操作部安裝到面板要領

- ①面板安裝孔尺寸  $\phi 22.3$ （標準）時  
如圖所示開關操作部從面板前面插入面板安裝孔內，鎖緊環從面板背面旋轉鎖附，再使用鎖緊環扳手（A29Z-T1）確實旋緊鎖緊環。

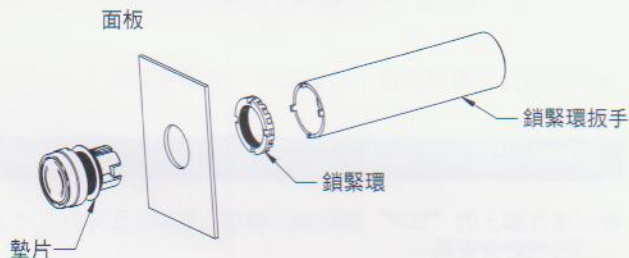

- ②面板安裝孔尺寸  $\phi 25.5$ 時，面板背面之鎖緊環，其凸起的一面向面板側，並使凸起全週完全進入安裝孔內，其餘與前述要領相同。

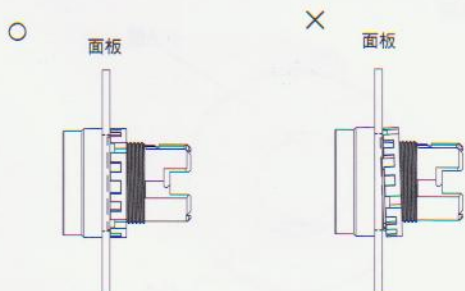
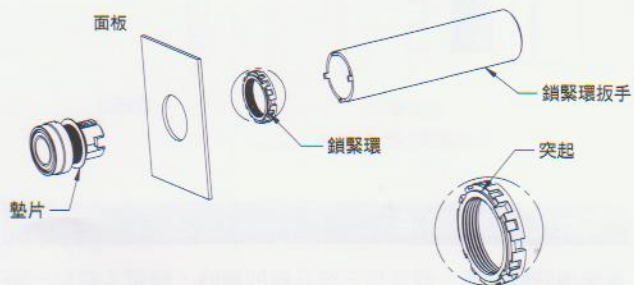

- ③建議扭矩為2.0N.m以下，切勿使用鉗子或過度鎖緊以免損壞鎖緊環。

- ④適用標準面板厚度0.8-6mm（包含表面處理膜厚）；使用防轉環（A29Z-RL）時，適用面板厚度為1.2-4.5mm；使用鎖扣罩（A29Z-KL1）時，適用面板厚度為0.8-3.2mm。

- ⑤安裝燈泡時，勿對燈泡施加過大的外力，以免損壞燈座。

## 配線施工注意事項

- ①使用直流LED燈時，應將標示X1之端子配線為正極。
- ②接線螺絲為M3.5的一十字頭附方形墊片螺絲；建議鎖緊扭矩為1.0-1.3N.m。
- ③單心線 / 絞線 / 開口型壓接端子 皆可使用；電線規格14-16 AWG。
- ④配線作業時及完成後，端子部分不應承受外力，否則可能引起動作異常。
- ⑤配線完成後，需保持適當絕緣距離。

## 燈罩及文字記名板注意事項

### ◆燈罩及文字記名板的安裝順序

- ①照光按鈕開關



# Ø22 A20 系列控制元件

## ②指示燈



## ③文字記名板尺寸

照光按鈕開關和指示燈的文字及符號可以雕刻在燈罩內的文字記名板上，或在燈罩內加入印有文字及符號的薄膜。薄膜非標配，請用戶準備。

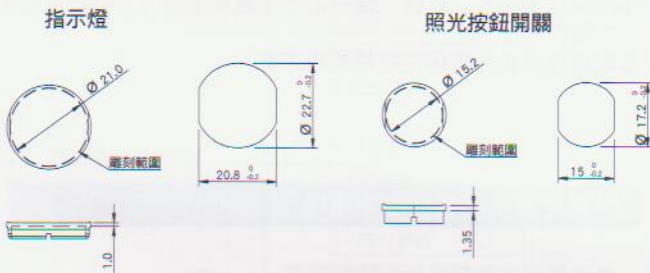

## 燈泡安裝注意事項

◆可從面板前面直接裝置燈泡，或拆下接點部（或轉接器）燈泡裝置完成再裝回接點部。

①如圖所示，將燈泡頭部插入燈泡更換工具（A20R-55）末端凹穴內。

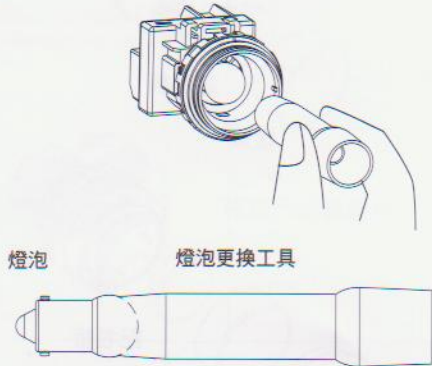

②將燈泡底部的安裝扣腳對準燈座凹槽，再將燈泡更換工具（A20R-55）輕向內壓使燈泡深入燈座內部，同時向順時針方向旋轉。

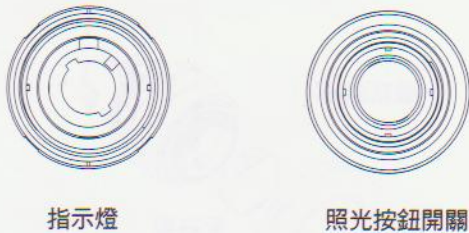

③拆下時依反向旋轉，安裝燈泡時，勿對燈泡施加過大的外力，以免損壞燈座。

## 開關接點塊及全電壓轉接器安裝注意事項

### ◆拆卸

①如下圖所示，使用一字型螺絲起子鬆開接點塊安裝轉接器（A20B-E00P）之接點塊安裝扣。

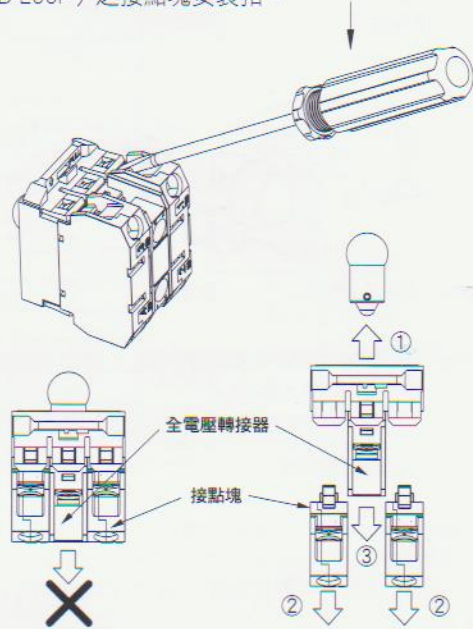

②拆卸全電壓轉接器（A20-E00P）之前，必須先拆除燈泡和接點塊。

◆安裝時全電壓轉接器（A20-E00P）必須優先裝入。

## 防轉環安裝注意事項

◆將操作部上的“TOP”標記與防轉環上的A部及安裝面板上的凹槽對齊安裝。

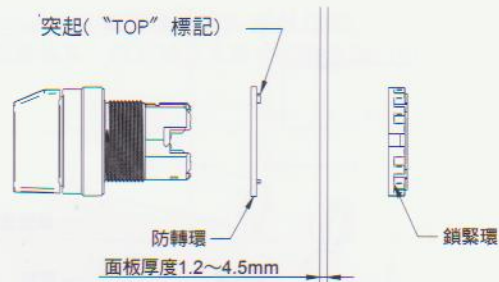

## 銘板使用注意事項

◆無須防轉功能，或面板安裝孔無凹槽時，請用尖嘴鉗折斷銘板的A部。

