

Ultra-small devices
PIMITES
[p:i:m:i:t:s]

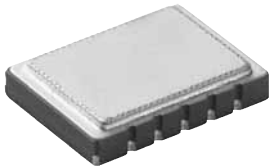

FEATURES

- 1. High precision and high sensitivity**
±5% FS overall accuracy and 1 V/g detection sensitivity.
- 2. High reliability**
Detection errors due to temperature fluctuation reduced to a minimum.
- 3. Compact size**
6.2 (L) mm × 8.5 (W) mm × 1.6 mm (H) (typ.)

APPLICATIONS

- 1. Car navigation system**
Distinguish between regular roads and highways (inclination sensor)



- 2. Automotive control**
Skid prevention system, 4 WD-ABS, Rollover prevention system (inclination and acceleration detection)
- 3. Other applications**
Projectors (trapezoidal compensation), Elevators, Medical caregiving devices (inclination detection)

RoHS Directive compatibility information
<http://www.nais-e.com/>

ORDERING INFORMATION

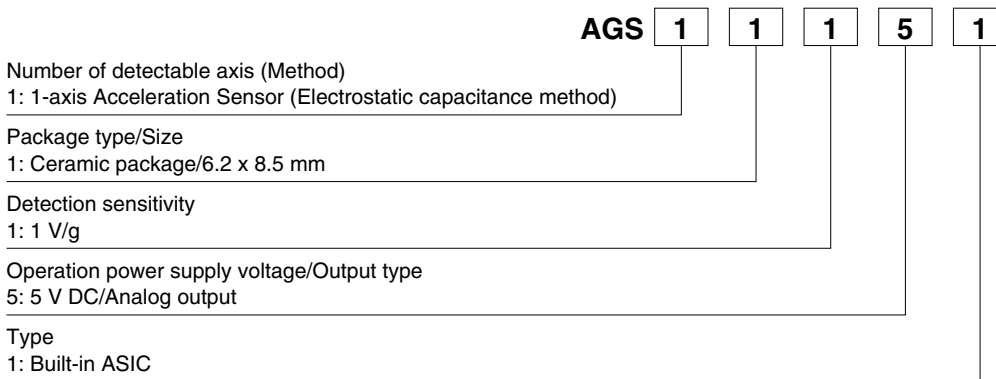

PRODUCT TYPES

Product name	Operation power supply voltage	Acceleration detection range	Detection sensitivity	Part number
1-axis Acceleration sensor GS1	5 V DC	±2g	1 V/g	AGS11151

Note: Packaging format: Tape and reel (Outer carton: 5,000 pcs. Inner carton: 1,000 pcs.)

MAXIMUM RATING

Item	Unit	Standard value			Remarks
		min.	typ.	max.	
Maximum allowable voltage	V	-0.3	—	7	Ta=25°C
Storage temperature range	°C	-40	—	85	
Operation temperature range	°C	-40	—	85	
Anti-shock characteristic	g	5,000	—		

ELECTRICAL CHARACTERISTICS

Item	Unit	Standard value			Remarks
		min.	typ.	max.	
Acceleration detection range	g	-2	—	2	
Operation power supply voltage	V	4.75	5	5.25	-40 to 85°C
Current consumption	mA	—	5	7	0g, Ta=25°C
Sensitivity	V/g	0.97	1	1.03	Ta=25°C
Temperature sensitivity characteristic	V/g	-0.05	—	0.05	-40 to 85°C
Offset voltage (0 g)	V	2.4	2.5	2.6	Ta=25°C
Offset voltage temperature characteristic	V	-0.125	—	0.125	-40 to 85°C
Other axis sensitivity	%	-5	—	5	Ta=25°C
Non-linearity ^{Note 3)}	%FS	-1	—	1	Ta=25°C
Turn-on time ^{Note 4)}	ms	—	10	—	0g, Ta=25°C C1=220nF, C2=27nF
Frequency response ^{Note 5)}	Hz	DC	60	—	-3dB point, C2=27nF

- Notes: 1. The acceleration unit "g" means 9.8 m/s².
 2. VDD=5 V when there is no indication.
 3. Maximum error from linear output that connects +2 g and -2 g output.
 4. "C1" is a ceramic capacitor installed between the VDD and GND terminals. "C2" is a ceramic capacitor installed between the Vout and Ext-Cap terminals.
 5. The frequency characteristics can be changed depending on the C2 capacitance value. Please refer to "Recommended circuit diagram" on the following page. Note that the maximum frequency response is 200 Hz.

REFERENCE DATA

1. Output characteristics

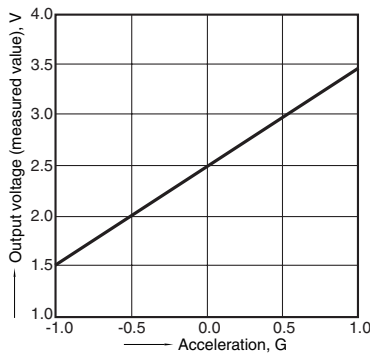

2. Inclination angle - Output voltage characteristics

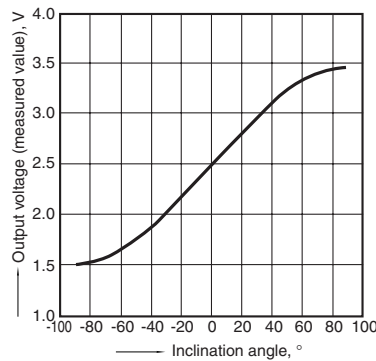

3. Offset voltage temperature characteristics (Typical value)

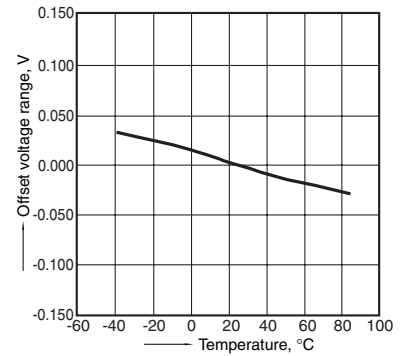

4. Sensitivity temperature characteristics (Typical value)

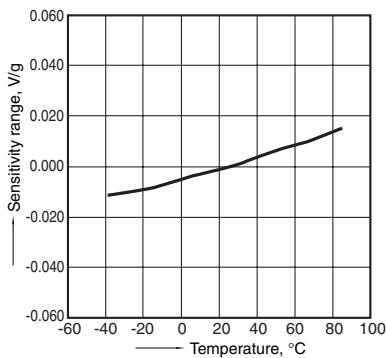

5. Frequency characteristics (Typical value)

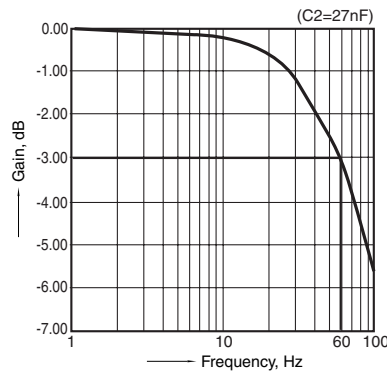

Note: The frequency characteristics can be changed depending on the C2 capacitance value. Please refer to "Recommended circuit diagram" on the following page.

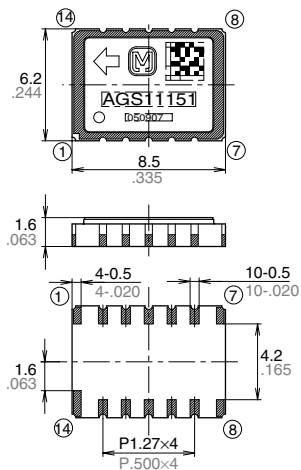

Tolerance: $\pm 0.2 \pm .008$

Terminal No.	Abbreviation	Terminal No.	Abbreviation
①	NC	⑧	NC
②	GND	⑨	VDD
③	NC	⑩	NC
④	Vout	⑪	NC
⑤	Ext-Cap	⑫	NC
⑥	GND	⑬	NC
⑦	NC	⑭	NC

Leave terminal "NC (No. 1, 3, 7, 8 and 10 to 14)" unconnected.
The No. 2 and No. 6 terminals are connected internally.

Recommended PC board pad

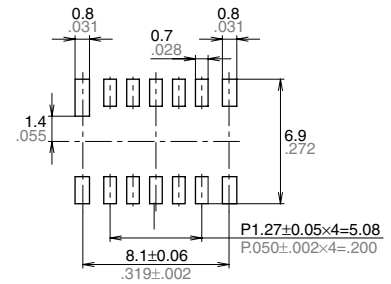

RECOMMENDED CIRCUIT DIAGRAM

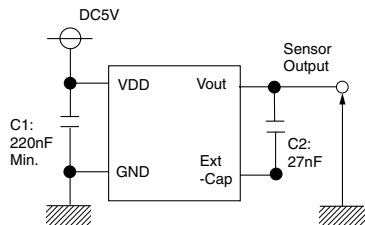

The frequency characteristics value can be changed depending on the C2 capacitance value.
-3dB bandwidth is expressed in the formula below.

$$f_{-3dB} = \frac{1}{2\pi \times (100k\Omega) \times C2}$$

PACKAGING FORMAT (Tape and reel)

Tape dimensions

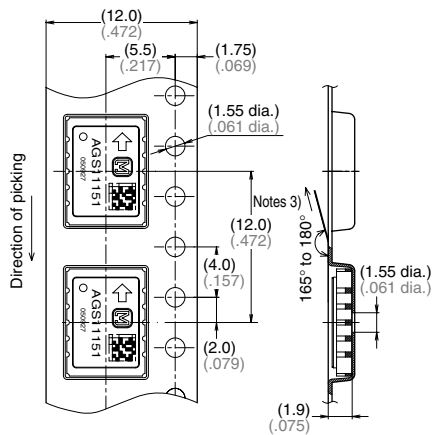

Dimensions of tape reel

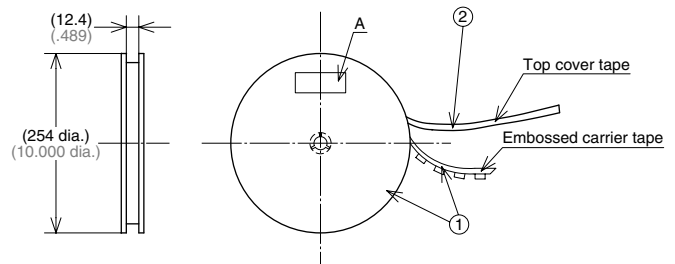

NOTES

To ensure reliability, please verify quality under conditions of actual use.

1. Mounting

Use lands on the printed-circuit boards to which the sensor can be securely fixed.

2. Soldering

Take steps to minimize the effects of external heat.

Damage and changes to characteristics may occur due to heat deformation.

Use a non-corrosive resin type of flux.

1) Manual soldering

- Set the soldering tip from 260 to 300°C (30W), and solder for no more than 5 seconds.

- Please note that output may change if the pressure is applied on the terminals when the soldering.

- Thoroughly clean the soldering iron.

2) Reflow soldering

- The recommended reflow temperature profile conditions are given below.

- We recommend the screen solder printing method as the method for cream solder printing.

- Please refer to the recommended PC board pad for the PC board foot pattern.

- Self alignment may not always work as expected; therefore, please carefully

- adjust the position of the terminals and pattern.

- The profile temperature is the value measured on the PCB near the terminals.

- When doing reflow soldering on the back of the PC board after performing sensor reflow, please fix the sensor with adhesive and so on.

3) Solder reworking

- Finish reworking in one operation.

- For reworking of the solder bridge, use a soldering iron with a flat tip. Please do not add more flux when reworking.

- Please use a soldering iron that is below the temperature given in the specifications in order to maintain the correct temperature at the tip of the soldering iron.

4) Too much temperature on the terminals will cause deformation and loss in effectiveness of the solder. Therefore, please avoid dropping and careless handling of the product.

5) When cut folding the PC board after mounting the sensor, take measures to prevent stress to the soldered parts.

6) The sensor terminals are designed to be exposed, so contact of the terminals with metal shards and the like will cause output errors. Therefore, please be careful and prevent things such as metal shards and hands from contacting the terminals.

7) To prevent degradation of the PC board insulation after soldering, please be careful not to get chemicals on the sensor when coating.

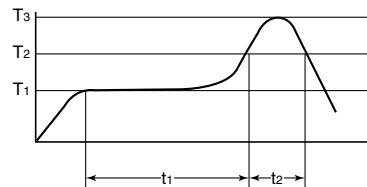

$T_1 = 150 \text{ to } 180^\circ\text{C } 302 \text{ to } 356^\circ\text{F}$
 $T_2 = 230^\circ\text{C } 446^\circ\text{F}$
 $T_3 = \text{Max. } 240^\circ\text{C } 464^\circ\text{F}$
 $t_1 = 60 \text{ to } 120 \text{ sec.}$
 $t_2 = \text{With in } 30 \text{ sec.}$

3. Connections

- Please perform connections correctly in accordance with the terminal connection diagram. In particular, be careful not to reverse wire the power supply as this will cause damage or degrade to the product.

- Do not connect terminals that are not used. This can cause malfunction of the sensor.

4. Cleaning

- Avoid ultrasonic cleaning since this may cause breaks or disconnections in the wiring.

5. Environment

- Please avoid using or storing the sensor in a place exposed to corrosive gases (such as the gases given off by organic solvents, sulfurous acid gas, hydrogen sulfides, etc.) which will adversely affect the performance of the sensor.

- When installing the sensor, you must provide a capacitor as shown in the recommended circuit diagram.

- Since the internal circuitry may be destroyed if an external surge voltages is supplied, provide an element which will absorb the surges.

- Malfunctioning may occur if the product is in the vicinity of electrical noise such as that from static electricity, lightning, a broadcasting station, an amateur radio, or a mobile phone.

- Please do not use the sensor in a location where it may be sprayed with water, etc.

- Avoid using the sensor in an environment where condensation may form.

Furthermore, its output may fluctuate if any moisture adhering to it freezes.

- Avoid using the sensor where it will be susceptible to ultrasonic or other high-frequency vibration.

6. Other handling precautions

To assure reliability, check the sensor under actual loading conditions. Avoid any situation that may adversely affect its performance.

- Caution is required because differences in the acceleration detection range and the method of connection can lead to accidents.

- The actual acceleration should be within the rated acceleration range. Damage may occur if it is outside of this range.

- Static electricity can damage the sensor. Be very careful when handling.