

TYPE:T33M (貫通式端子台) **Modular**(モジュール式)

Pitch:8.25mm

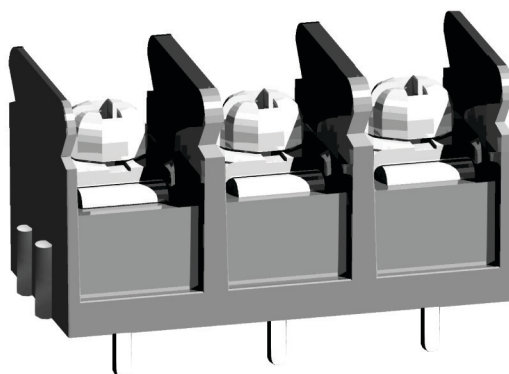

NEW



ORDER GUIDE(注文方法):

T33M B M11 - 03

Body(本体)		Terminal style(端子スタイル)		Poles(極数)
B: 標準型 (standard)	E: 両端取付穴無しカバー付 (with cover)	M11:	O31:	02
		M21:	O32:	⋮
C: 両端取付穴付カバー付 (with mounts and cover)	O: 両端取付穴付カバー無し (with mounts)	M32:		⋮
		M34:		⋮
				30

SPECIFICATION(規格,仕様):

Terminal :	Brass, Tin plated,0.8 t	端子 :	黄銅板ハンダメッキ,0.8 t
Insulator body :	Polyamide66(UL94V-0),Green	主絶縁体 :	Polyamide66(UL94V-0),緑色
Screw :	M3.0, steel, Ni plated	ネジ :	M3.0, 鉄ニッケルメッキ
Cover :	PC	カバー :	PC
Operation temperatures :	-40° C to +105° C	使用温度範囲 :	-40° C to +105° C
Rated current :	15Amp AC300V	定格 :	15Amp AC300V
Insulation withstands volt :	AC2000V min	耐電圧 :	AC2000V 一分間
Insulation resistance :	>5000MΩ at DC 500V	絶縁抵抗 :	DC500V 5000MΩ以上
PCB hole Dia :	φ 1.6mm~φ 1.8mm	基板穴径 :	φ 1.6mm~φ 1.8mm
Wire range :	16~22 AWG	電線径 :	16~22 AWG
Screw torque :	12 lb-in Screw with washer	ネジ締付トルク :	12 lb-in ワッシャー付ネジ

.325" PCB Barrier Terminal Blocks

DECA[®]
SwitchLab

TYPE:T33M

Modular(モジュール式)

Pitch:8.25mm

T33MBM11-03

Terminal style: M11

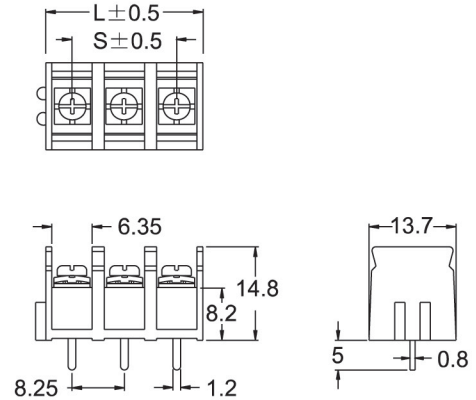
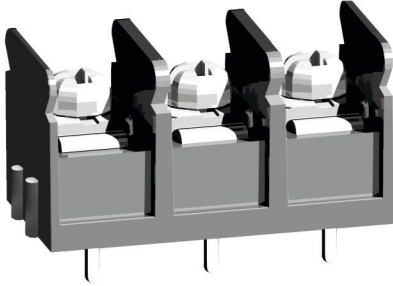

T33MBM21-03

Terminal style: M21

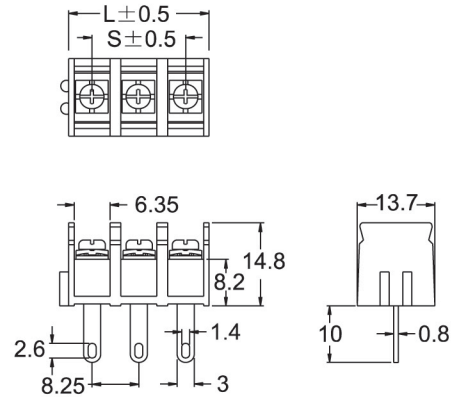
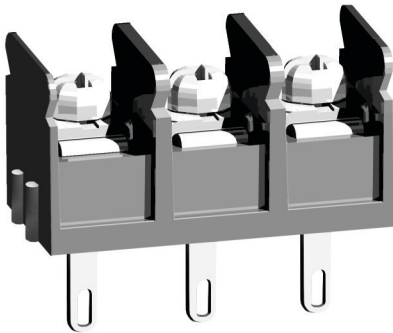

T33MBM32-03

Terminal style: M32

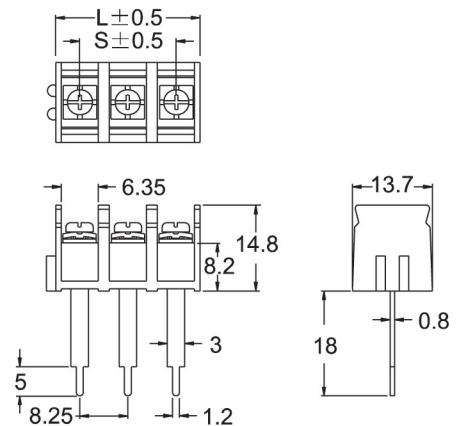
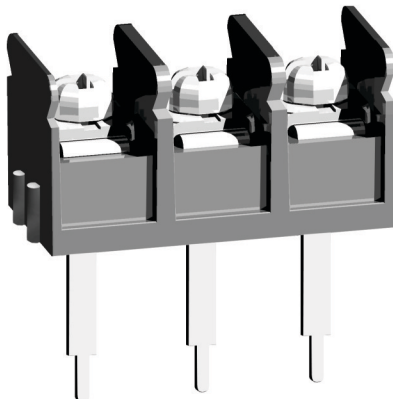

Poles	2	3	4	5	6	7	8	9	10	11	12	13	14	15	16
L(mm)	16.5	24.8	33.0	41.3	49.5	57.8	66.0	74.3	82.5	90.8	99.0	107	116	124	132
S(mm)	8.25	16.5	24.8	33.0	41.3	49.5	57.8	66.0	74.3	82.5	90.8	99.0	107	116	124
Poles	17	18	19	20	21	22	23	24	25	26	27	28	29	30	
L(mm)	140	149	157	165	173	182	190	198	206	215	223	231	239	250	
S(mm)	132	140	149	157	165	173	182	190	198	206	215	223	231	239	

.325" PCB Barrier Terminal Blocks

DECA[®]
SwitchLab

TYPE:T33M

Modular(モジュール式)

Pitch:8.25mm

T33MBM34-03

Terminal style: M34

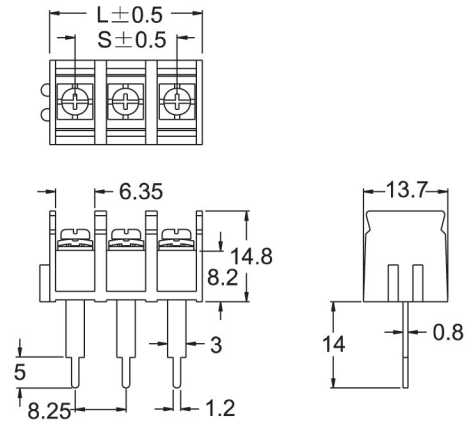
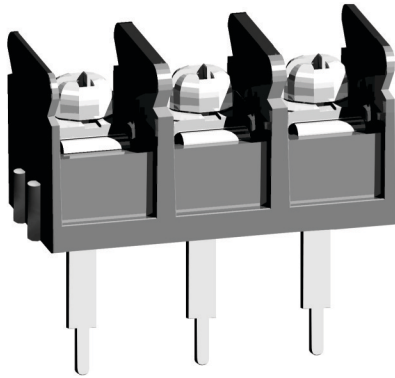

T33MBO31-03

Terminal style: O31

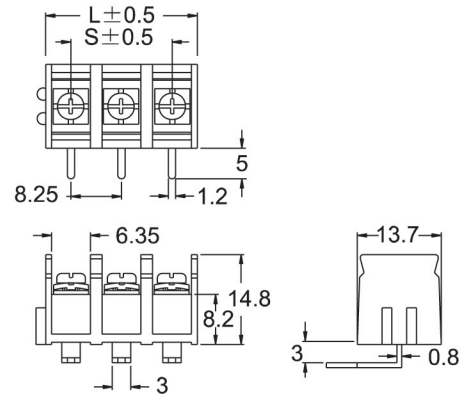
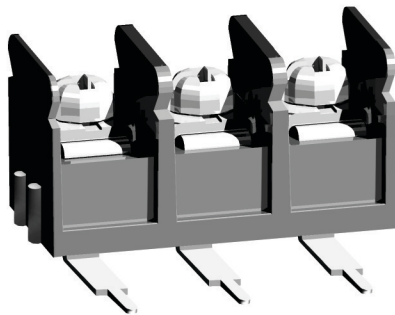

T33MBO32-03

Terminal style: O32

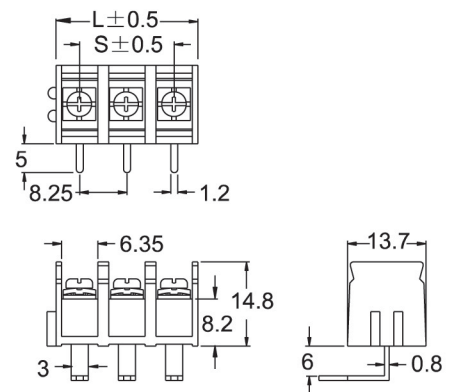
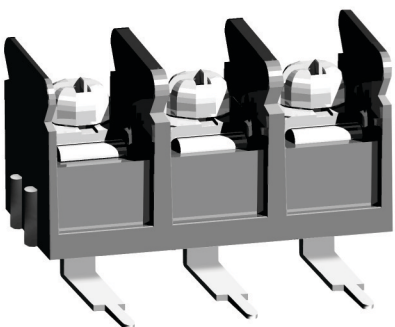

Poles	2	3	4	5	6	7	8	9	10	11	12	13	14	15	16
L(mm)	16.5	24.8	33.0	41.3	49.5	57.8	66.0	74.3	82.5	90.8	99.0	107	116	124	132
S(mm)	8.25	16.5	24.8	33.0	41.3	49.5	57.8	66.0	74.3	82.5	90.8	99.0	107	116	124
Poles	17	18	19	20	21	22	23	24	25	26	27	28	29	30	
L(mm)	140	149	157	165	173	182	190	198	206	215	223	231	239	250	
S(mm)	132	140	149	157	165	173	182	190	198	206	215	223	231	239	

.250" PCB Tri-Barrier Terminal Blocks

TYPE:T33M (貫通式端子台)

Modular(モジュール式)

Pitch:8.25mm

T33MBM11-02

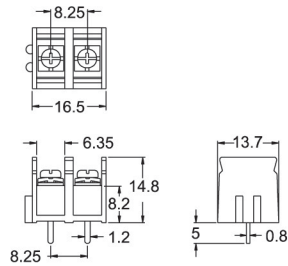
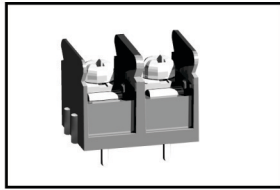

T33MBM11-03

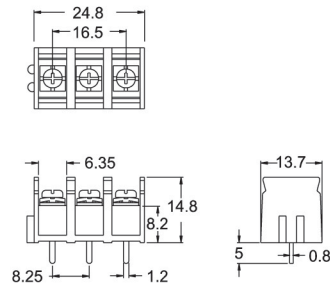
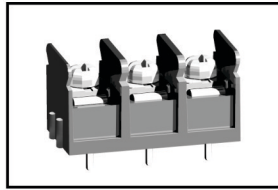

T33M-L01

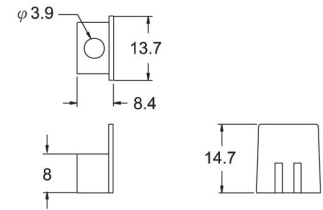
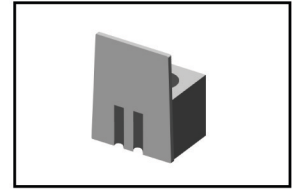

T33M-R01

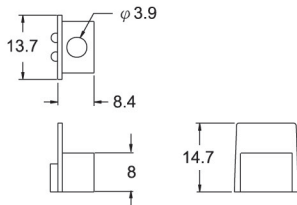
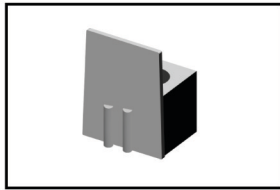

BC33M-□□

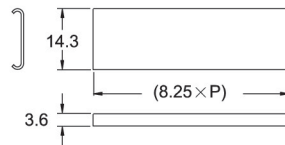
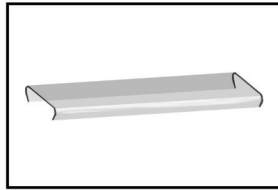

T33MBM11-02		2 pole modular
T33MBM11-03		3 pole modular
T33M-L01		mounting hole (left)
T33M-R01		mounting hole (right)
BC33M-□□		clear cover

.250" PCB Tri-Barrier Terminal Blocks













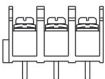



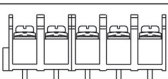

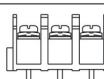
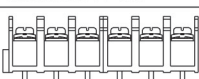
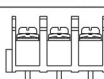
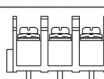
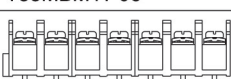

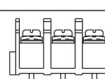





























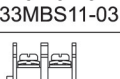

DECA[®]
SwitchLab

TYPE:T33M (貫通式端子台)

Modular(モジュール式)

Pitch:8.25mm

ORDER GUIDE

Housing	Assemble Breakdown			
 T33MBM11-02	 T33MBM11-02			
 T33MBM11-03	 T33MBM11-03			
 T33MBM11-04	 T33MBM11-02	 T33MBM11-02		
 T33MBM11-05	 T33MBM11-02	 T33MBM11-03		
 T33MBM11-06	 T33MBM11-03	 T33MBM11-03		
 T33MBM11-07	 T33MBM11-02	 T33MBM11-02	 T33MBM11-03	
 T33MBM11-08	 T33MBM11-02	 T33MBM11-03	 T33MBM11-03	
 T33MBM11-09	 T33MRS11-03	 T33MRS11-03	 T33MBS11-03	
 T33MBM11-10	 T33MBM11-02	 T33MBM11-02	 T33MBM11-03	 T33MBM11-03
 T33MBM11-11	 T33MBM11-02	 T33MBM11-03	 T33MBM11-03	 T33MBM11-03
 T33MBM11-12	 T33MBM11-03	 T33MBM11-03	 T33MBM11-03	 T33MBM11-03
 T33MOM11-02	 T33M-L01	 T33MMS11-02	 T33M-R01	
 T33MOM11-03	 T33M-L01	 T33MBS11-03	 T33M-R01	
 T33MOM11-04	 T33M-L01	 T33MRS11-02	 T33BS11-02	 T33M-R01
 T33MOM11-05	 T33M-L01	 T33MRS11-02	 T33MBS11-03	 T33M-R01