



Parameter	Rating	Units
Load Voltage	60	V _p
Load Current	500	mA
Max On-resistance	2	Ω

Features

- Small 6-Pin DIP Package
- Low Drive Power Requirements (TTL/CMOS Compatible)
- No Moving Parts
- High Reliability
- Arc-Free With No Snubbing Circuits
- 3750V_{rms} Input/Output Isolation
- No EMI/RFI Generation
- Machine Insertable, Wave Solderable
- Tape & Reel, Surface Mount Version Available

Applications

- Sensor Circuitry
- Instrumentation
- Multiplexers
- Data Acquisition
- Electronic Switching
- I/O Subsystems
- Meters (gas, oil, electric and water)
- Medical Equipment-Patient/Equipment Isolation
- Security
- Aerospace
- Industrial Controls

Description

LCB716 is a 1-Form-B solid state relay that uses optically coupled relay technology to provide an enhanced 3750V_{rms} isolation barrier between the input and the output of the relay. The efficient MOSFET switches use Clare's patented OptoMOS architecture. The optically coupled output is controlled by a highly efficient GaAIAs infrared LED.

Approvals

- UL Recognized Component: File # E76270

Ordering Information

Part #	Description
LCB716	6-Pin DIP (50/Tube)
LCB716S	6-Pin Surface Mount (50/Tube)
LCB716STR	6-Pin Surface Mount (1000/Reel)

Pin Configuration

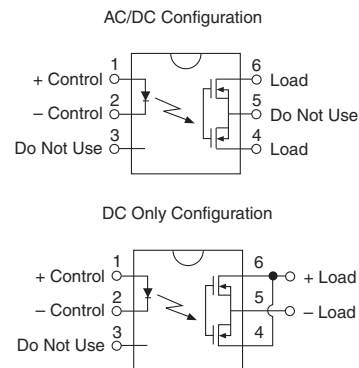

Switching Characteristics of Normally Closed (Form B) Devices

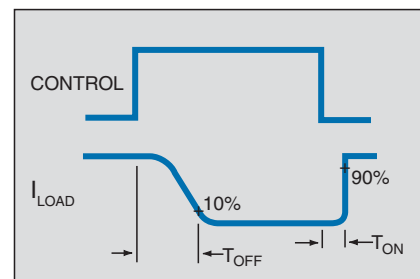

Absolute Maximum Ratings

Parameter	Ratings	Units
Blocking Voltage	60	V _P
Reverse Input Voltage	5	V
Input Control Current	50	mA
Peak (10ms)	1	A
Input Power Dissipation ¹	100	mW
Total Power Dissipation ²	800	mW
Isolation Voltage, Input to Output	3750	V _{rms}
Operational Temperature	-40 to +85	°C
Storage Temperature	-40 to +125	°C

¹ Derate Linearly 1.33 mw/°C

² Derate Linearly 6.67 mw/°C

Electrical absolute maximum ratings are at 25°C

Absolute Maximum Ratings are stress ratings. Stresses in excess of these ratings can cause permanent damage to the device. Functional operation of the device at conditions beyond those indicated in the operational sections of this data sheet is not implied.

Electrical Characteristics

Parameter	Conditions	Symbol	Min	Typ	Max	Units
Output Characteristics @ 25°C						
Load Current						
AC/DC Configuration, Continuous	-	I _L	-	-	500	mA
DC Configuration, Continuous	-		-	-	1000	
Peak	t ≤ 10ms	I _{LPK}	-	-	1.2	A
On-Resistance						
AC/DC Configuration	I _L =500mA	R _{ON}	-	1.63	2	Ω
DC Configuration	I _L =1000mA		-	0.4	0.5	
Off-State Leakage Current	I _F =2mA, V _L =60V	I _{LEAK}	-	-	1	μA
Output Capacitance	I _F =2mA, 50V, f=1MHz	C _{OUT}	-	280	-	pF
Switching Speeds						
Turn-On	I _F =5mA, V _L =10V	t _{ON}	-	0.58	3	ms
Turn-Off		t _{OFF}	-	0.76	3	
Input Characteristics @ 25°C						
Input Control Current	I _L =500mA	I _F	-	-	2	mA
Input Dropout Current	-	I _F	0.1	-	-	mA
Input Voltage Drop	I _F =5mA	V _F	0.9	1.2	1.4	V
Reverse Input Current	V _R =5V	I _R	-	-	10	μA
Common Characteristics @ 25°C						
Capacitance, Input to Output	-	C _{I/O}	-	3	-	pF

PERFORMANCE DATA*

Typical LED Forward Voltage Drop
(N=50, $T_A=25^\circ\text{C}$, $I_F=5\text{mA}$)

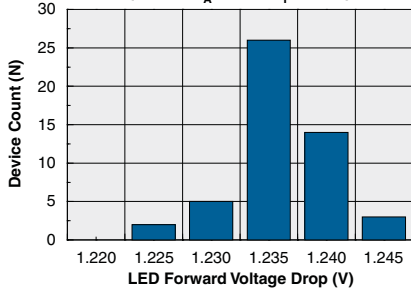

Typical On-Resistance
(N=50, $T_A=25^\circ\text{C}$, $I_L=5\text{mA}$, $I_F=0\text{mA}$)

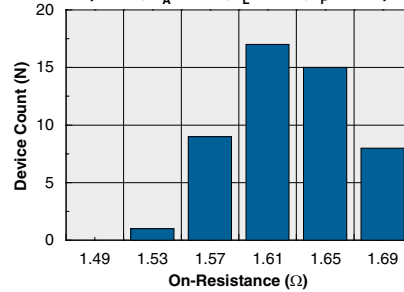

Typical Blocking Voltage
(N=50, $T_A=25^\circ\text{C}$, $I_F=2\text{mA}$)

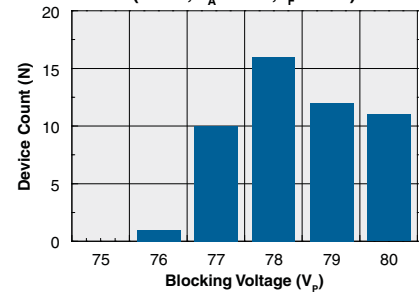

Typical I_F for Switch Operation
(N=50, $T_A=25^\circ\text{C}$, $I_L=200\text{mA}$)

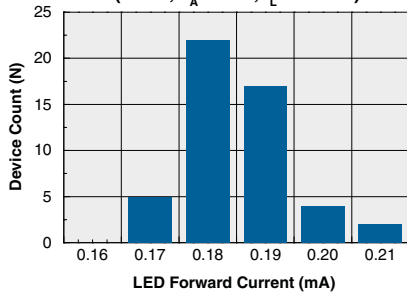

Typical Turn-On Time
(N=50, $T_A=25^\circ\text{C}$, $I_L=100\text{mA}$, $I_F=5\text{mA}$)

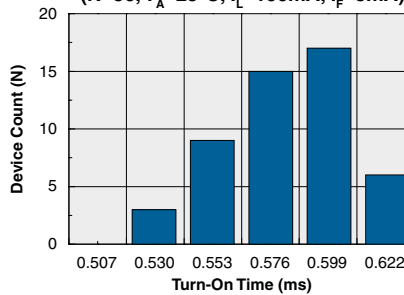

Typical Turn-Off Time
(N=50, $T_A=25^\circ\text{C}$, $I_L=100\text{mA}$, $I_F=5\text{mA}$)

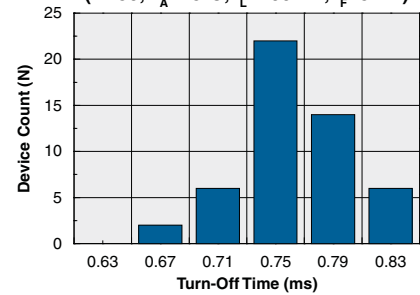

Typical Load Current vs. Temperature
($I_F=0\text{mA}$)

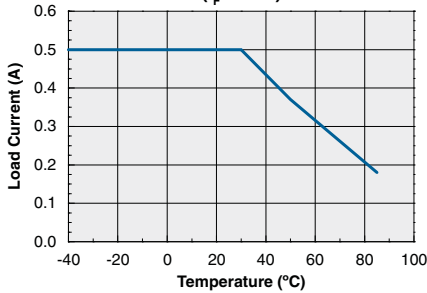

Typical Leakage vs. Temperature
Measured Across Pins 7&8
($I_F=5\text{mA}$, $V_L=60\text{V}$)

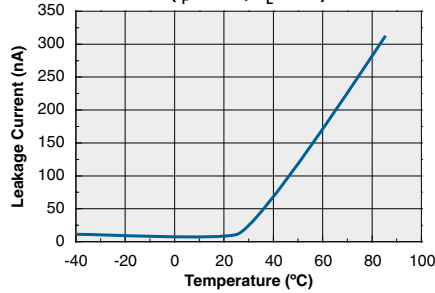

Typical Blocking Voltage vs. Temperature
($I_F=5\text{mA}$)

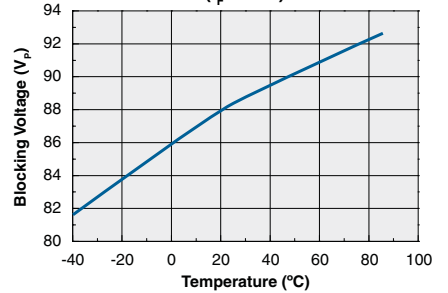

Typical Turn-On vs. Temperature
($I_L=100\text{mA}$)

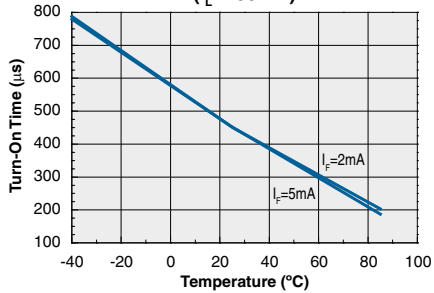

Typical Turn-Off vs. Temperature
($I_L=100\text{mA}$)

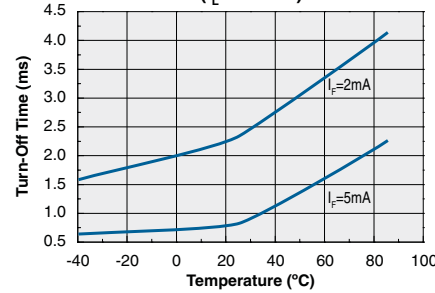

Typical Turn-On vs. LED Forward Current
($I_L=100\text{mA}$)

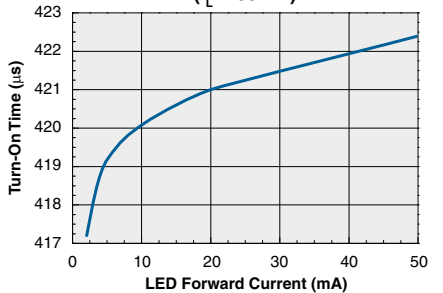

*The Performance data shown in the graphs above is typical of device performance. For guaranteed parameters not indicated in the written specifications, please contact our application department.

PERFORMANCE DATA*

Typical Turn-Off vs. LED Forward Current
($I_L=100\text{mA}$)

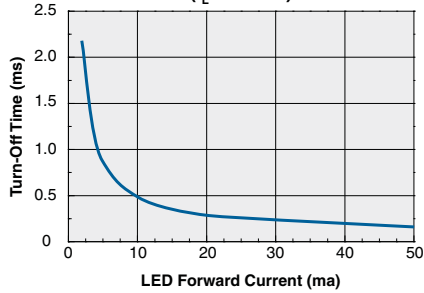

Typical On-Resistance vs. Temperature
($I_L=100\text{mA}$, $I_F=0\text{mA}$)

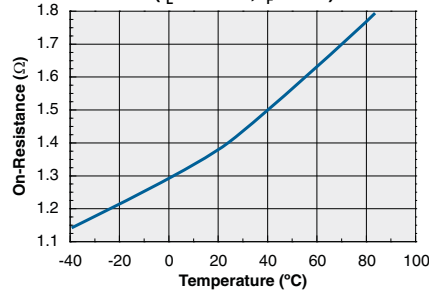

Typical I_F for Switch Operation
vs. Temperature
($I_L=100\text{mA}$)

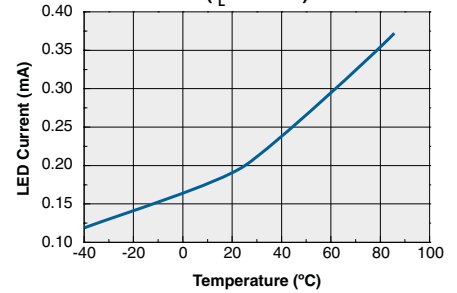

Typical Load Voltage vs. Load Current
($T_A=25^\circ\text{C}$, $I_F=0\text{mA}$)

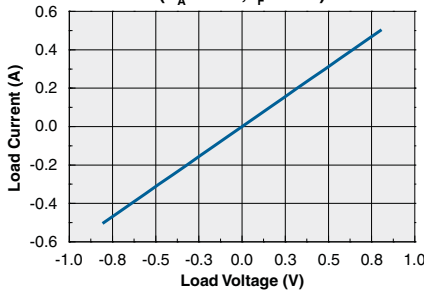

1-Form-B Relay
Energy Rating Curve

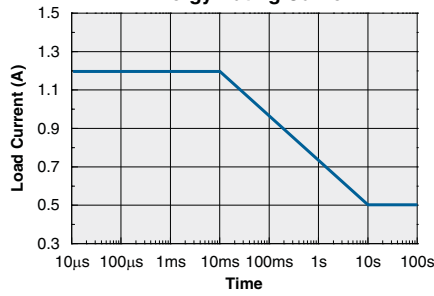

*The Performance data shown in the graphs above is typical of device performance. For guaranteed parameters not indicated in the written specifications, please contact our application department.

Manufacturing Information

Soldering

For proper assembly, the component must be processed in accordance with the current revision of IPC/JEDEC standard J-STD-020. Failure to follow the recommended guidelines may cause permanent damage to the device resulting in impaired performance and/or a reduced lifetime expectancy.

Washing

Clare does not recommend ultrasonic cleaning or the use of chlorinated solvents.



MECHANICAL DIMENSIONS

6-Pin DIP Thru-Hole Package

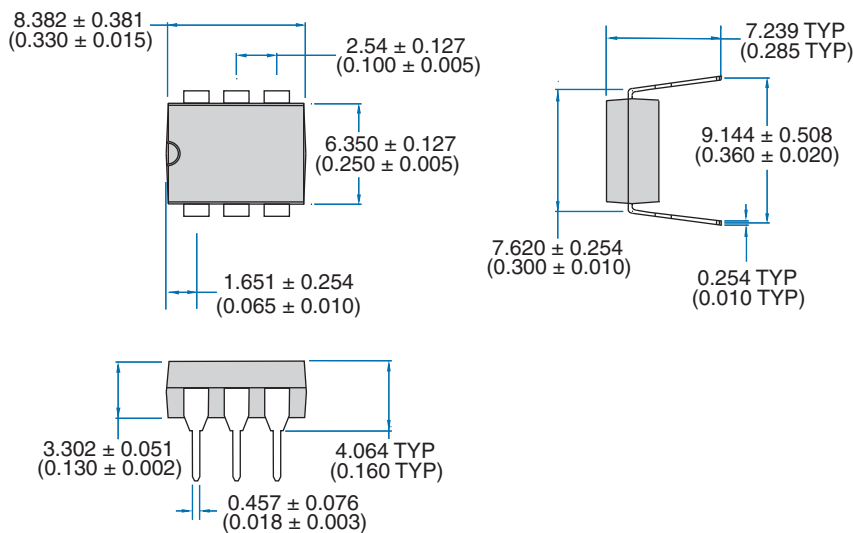

PC Board Pattern

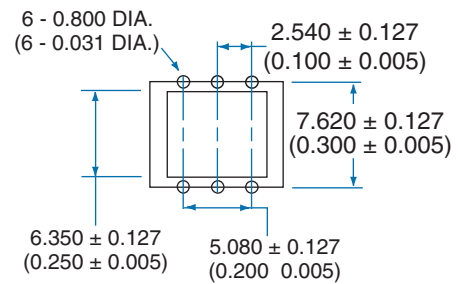

Dimensions
mm
(inches)

6-Pin Surface Mount Package ("S" Suffix)

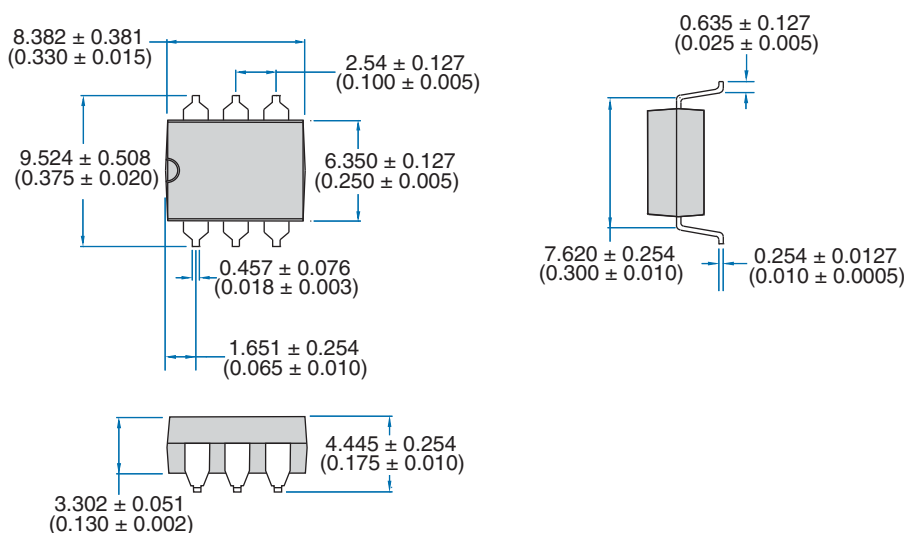

Recommended PCB Land Pattern

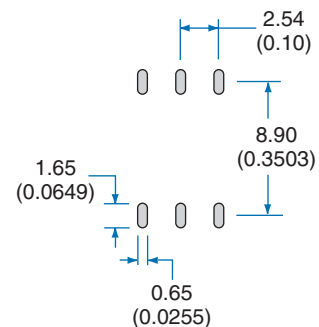

Dimensions
mm
(inches)

MECHANICAL DIMENSIONS

Tape and Reel Packaging for 6-Pin "S" Suffix Parts

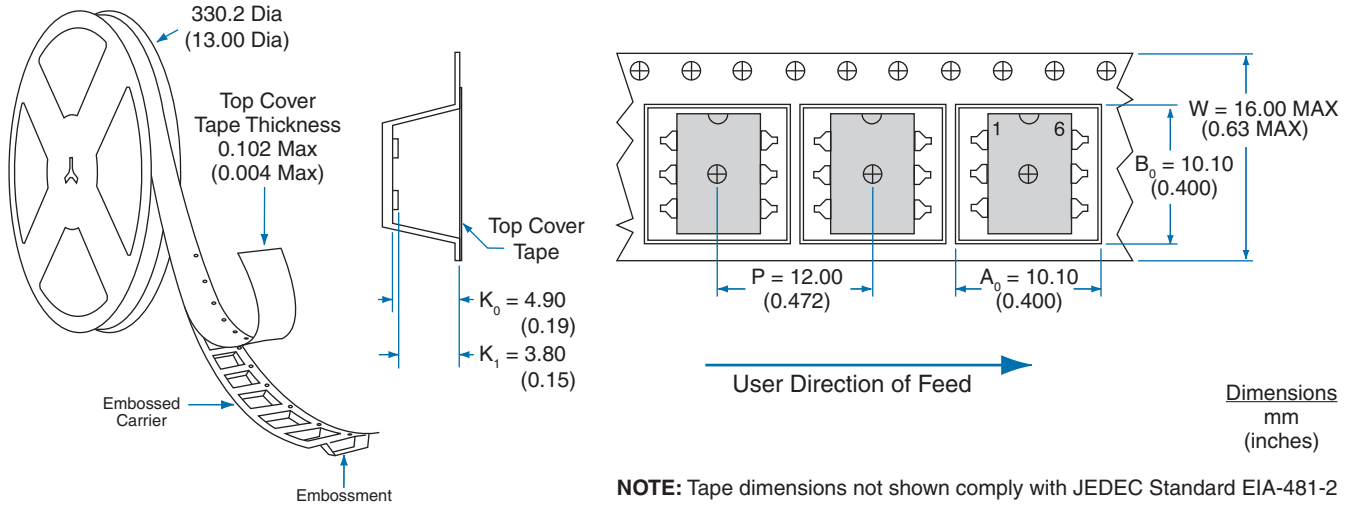

NOTE: Tape dimensions not shown comply with JEDEC Standard EIA-481-2

For additional information please visit our website at: www.clare.com

Clare, Inc. makes no representations or warranties with respect to the accuracy or completeness of the contents of this publication and reserves the right to make changes to specifications and product descriptions at any time without notice. Neither circuit patent licenses nor indemnity are expressed or implied. Except as set forth in Clare's Standard Terms and Conditions of Sale, Clare, Inc. assumes no liability whatsoever, and disclaims any express or implied warranty, relating to its products including, but not limited to, the implied warranty of merchantability, fitness for a particular purpose, or infringement of any intellectual property right.

The products described in this document are not designed, intended, authorized or warranted for use as components in systems intended for surgical implant into the body, or in other applications intended to support or sustain life, or where malfunction of Clare's product may result in direct physical harm, injury, or death to a person or severe property or environmental damage. Clare, Inc. reserves the right to discontinue or make changes to its products at any time without notice.

Specification: DS-LCB716-R01
©Copyright 2008, Clare, Inc.
OptoMOS® is a registered trademark of Clare, Inc.
All rights reserved. Printed in USA.
7/30/08