



Parameter	Rating	Units
Load Voltage	60	V
Load Current	1	A
Max On-resistance	0.4	Ω

Features

- 100% Solid State
- Small 8-Pin Package
- Low Drive Power Requirements (TTL/CMOS Compatible)
- Arc-Free With No Snubbing Circuits
- 3750V_{rms} Input/Output Isolation
- No EMI/RFI Generation
- Machine Insertable, Wave Solderable
- Surface Mount Versions
- Tape & Reel available

Applications

- Telecommunications
- Instrumentation
 - Multiplexers
 - Data Acquisition
 - Electronic Switching
 - I/O Subsystems
 - Utility Meters (gas, oil, electric and water)
- Medical Equipment-Patient/Equipment Isolation
- Security
- Aerospace
- Industrial Controls

Pin Configuration

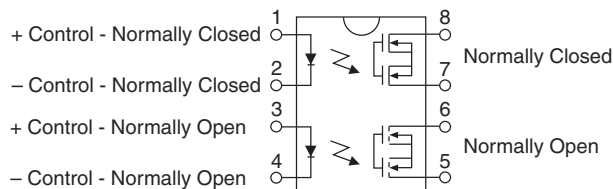

Description

LBA716 is 60V, 1A, 0.4Ω dual Solid State Relay integrating independent 1-Form-A and 1-Form-B relays into a single package. It features a superior combination of low on-resistance and enhanced peak load current (5A max.) handling capability.

Approvals

- UL Recognized Component: File # E76270
- CSA Certified Component: Certificate # 1175739
- EN/IEC 60950-1 Compliant

Ordering Information

Part #	Description
LBA716	8-Pin DIP (50/Tube)
LBA716S	8-Pin Surface Mount (50/Tube)
LBA716STR	8-Pin Surface Mount (1000/Reel)

Switching Characteristics of Normally Open (Form A) Devices

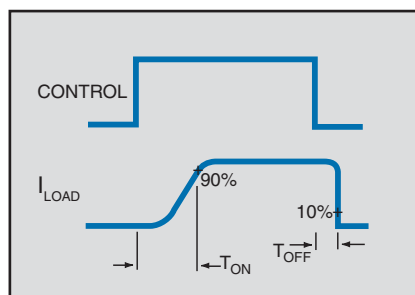

Switching Characteristics of Normally Closed (Form B) Devices

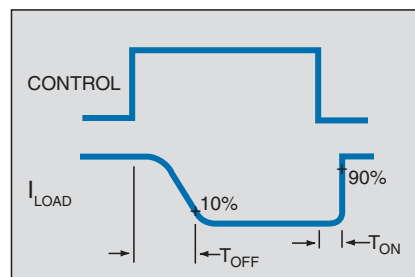

Absolute Maximum Ratings

Parameter	Ratings	Units
Blocking Voltage	60	V _P
Reverse Input Voltage	5	V
Input Control Current	50	mA
Peak (10ms)	1	A
Input Power Dissipation ¹	150	mW
Total Power Dissipation ²	800	mW
Isolation Voltage, Input to Output	3750	V _{rms}
Operational Temperature	-40 to +85	°C
Storage Temperature	-40 to +125	°C

¹ Derate Linearly 1.33 mw/°C

² Derate Linearly 6.67 mw/°C

Electrical absolute maximum ratings are at 25°C

Absolute Maximum Ratings are stress ratings. Stresses in excess of these ratings can cause permanent damage to the device. Functional operation of the device at conditions beyond those indicated in the operational sections of this data sheet is not implied.

Electrical Characteristics

Parameter	Conditions	Symbol	Min	Typ	Max	Units
Output Characteristics @ 25°C						
Form-A (Normally Open) Characteristics						
Load Current						
Continuous	-	I _L	-	-	1	A
Peak	t ≤ 10ms	I _{LPK}	-	-	5	
On-resistance	I _L =1A	R _{ON}	-	0.21	0.4	Ω
Off-State Leakage Current	V _L =60V	I _{LEAK}	-	-	1	μA
Output Capacitance	50V, f=1MHz	C _{OUT}	-	105	-	pF
Switching Speeds						
Turn-On	I _F =5mA, V _L =10V	t _{ON}	-	0.7	5	ms
Turn-Off		t _{OFF}	-	0.09	5	
Form-B (Normally Closed) Characteristics						
Load Current						
Continuous	-	I _L	-	-	0.5	A
Peak	t ≤ 10ms	I _{LPK}	-	-	1.2	
On-resistance	I _L =0.5A	R _{ON}	-	1.63	2	Ω
Off-State Leakage Current	V _L =60V, I _F =5mA	I _{LEAK}	-	-	1	μA
Output Capacitance	I _F =5mA, 50V, f=1MHz	C _{OUT}	-	280	-	pF
Switching Speeds						
Turn-On	I _F =5mA, V _L =10V	t _{ON}	-	0.58	5	ms
Turn-Off		t _{OFF}	-	0.76	5	
Input Characteristics @ 25°C						
Form-A and Form-B Characteristics						
Input Control Current	I _L =Load Current	I _F	-	-	2	mA
Input Dropout Current	-	I _F	0.1	-	-	mA
Input Voltage Drop	I _F =5mA	V _F	0.9	1.2	1.4	V
Reverse Input Current	V _R =5V	I _R	-	-	10	μA
Common Characteristics @ 25°C						
Capacitance, Input to Output	-	C _{I/O}	-	3	-	pF

*NOTE: If both poles operate simultaneously load current must be derated so as not to exceed the package power dissipation value.

PERFORMANCE DATA*

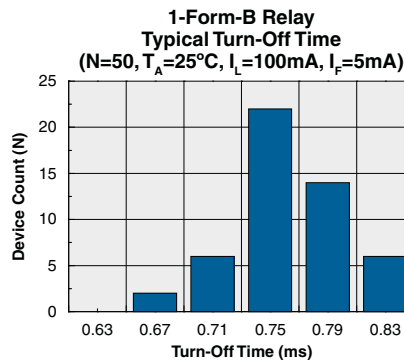
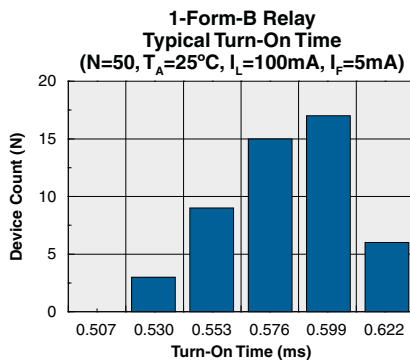
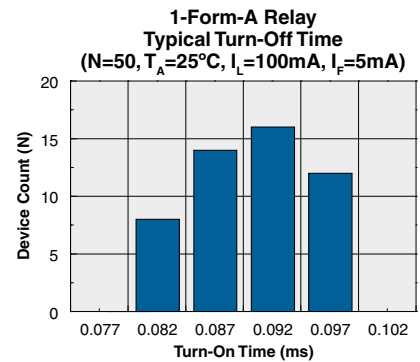
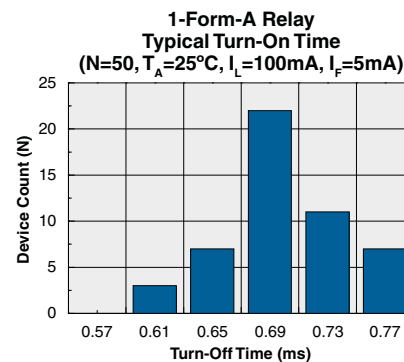
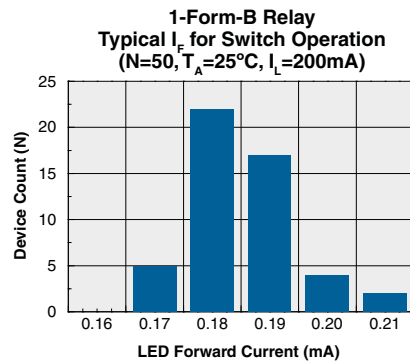
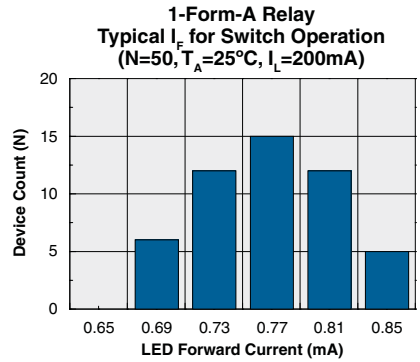
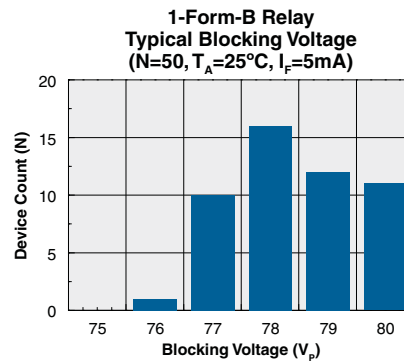
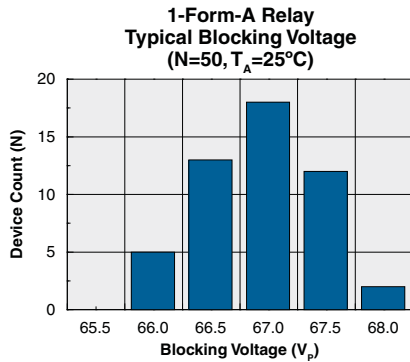
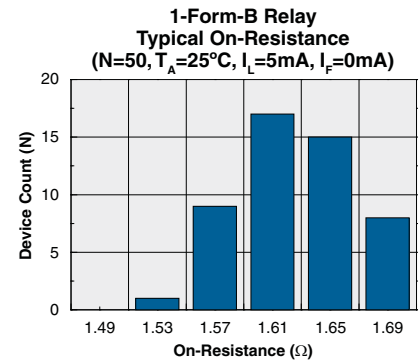
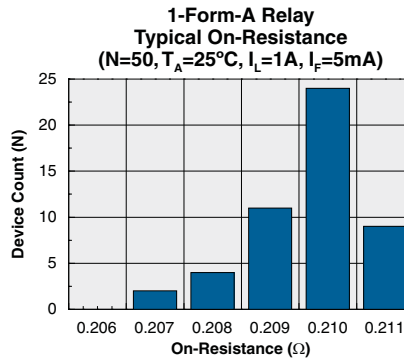
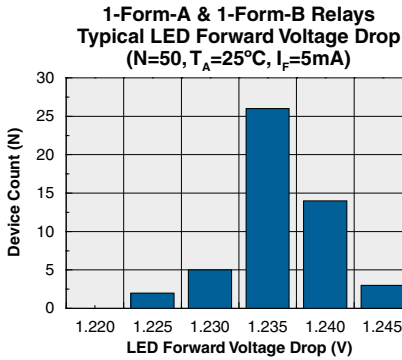

*The Performance data shown in the graphs above is typical of device performance. For guaranteed parameters not indicated in the written specifications, please contact our application department.

PERFORMANCE DATA*

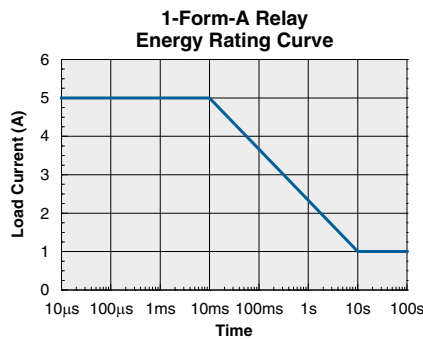
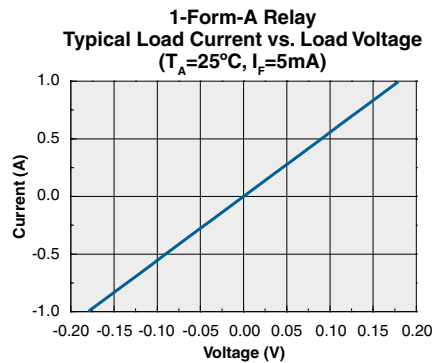
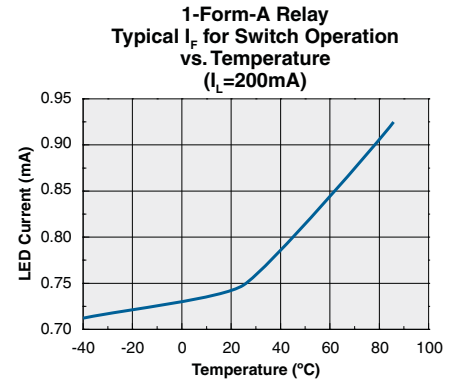
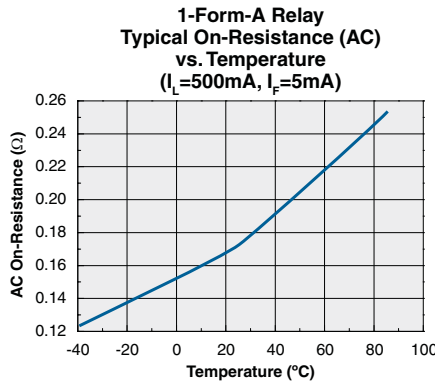
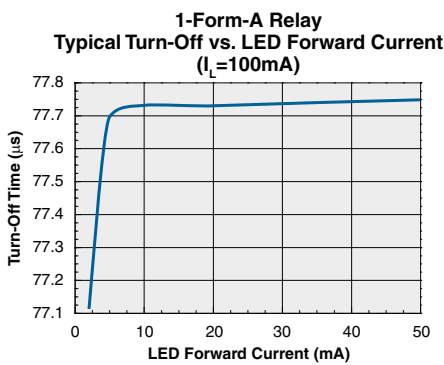
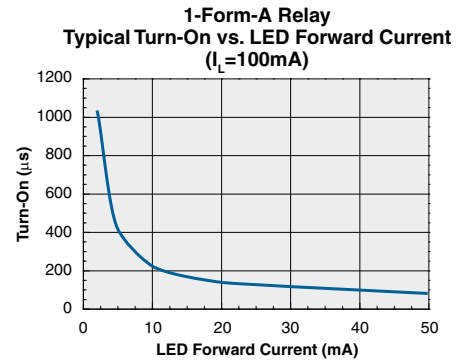
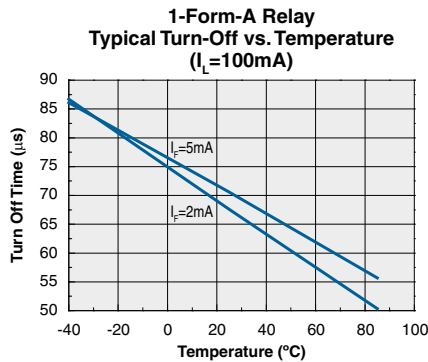
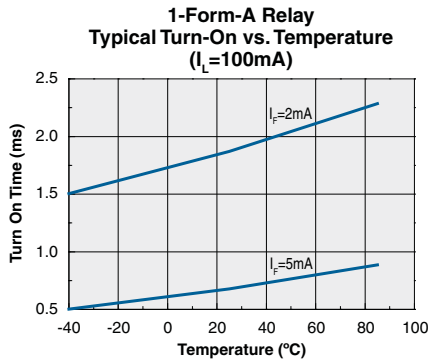
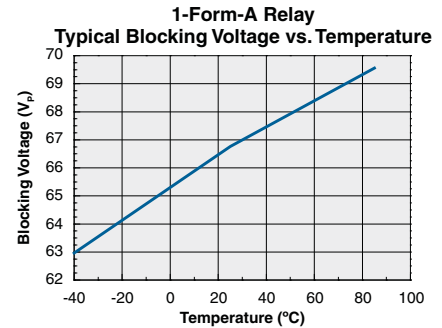
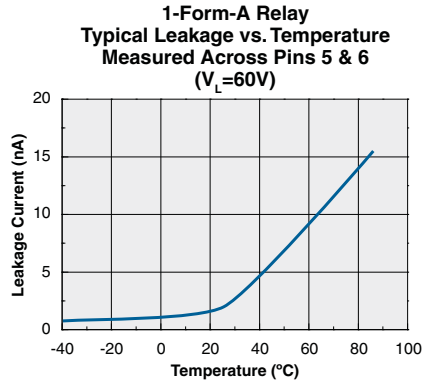
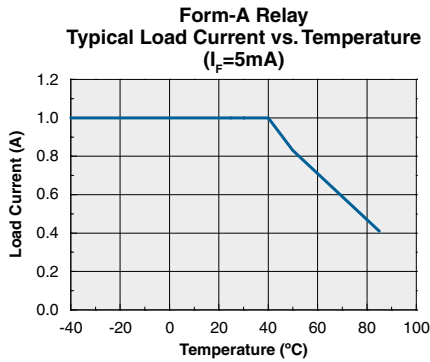

*The Performance data shown in the graphs above is typical of device performance. For guaranteed parameters not indicated in the written specifications, please contact our application department.

PERFORMANCE DATA*

**Form-B Relay
Typical Load Current vs. Temperature
($I_F=0mA$)**

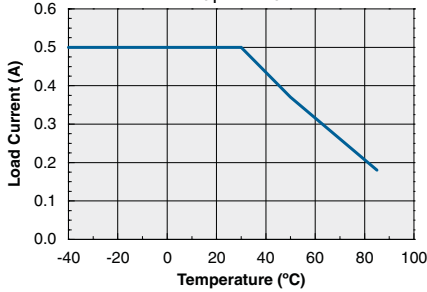

**1-Form-B Relay
Typical Leakage vs. Temperature
Measured Across Pins 7&8
($I_F=5mA, V_L=60V$)**

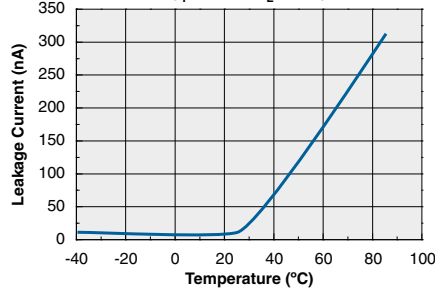

**1-Form-B Relay
Typical Blocking Voltage vs. Temperature
($I_F=5mA$)**

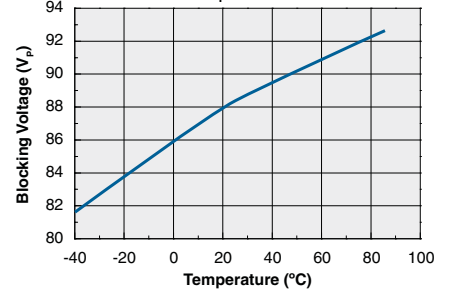

**1-Form-B Relay
Typical Turn-On vs. Temperature
($I_L=100mA$)**

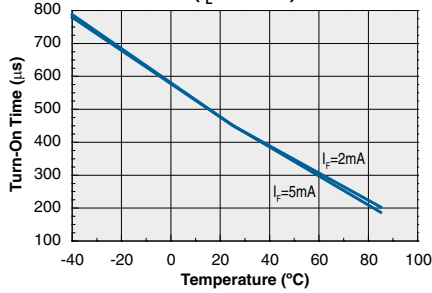

**1-Form-B Relay
Typical Turn-Off vs. Temperature
($I_L=100mA$)**

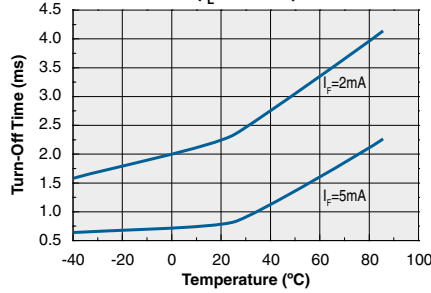

**1-Form-B
Typical Turn-On vs. LED Forward Current
($I_L=100mA$)**

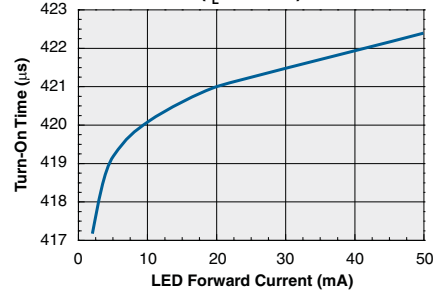

**1-Form-B Relay
Typical Turn-Off vs. LED Forward Current
($I_L=100mA$)**

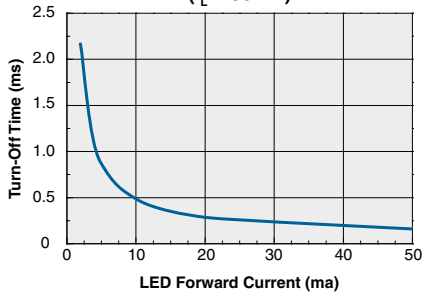

**1-Form-B Relay
Typical On-Resistance vs. Temperature
($I_L=100mA, I_F=0mA$)**

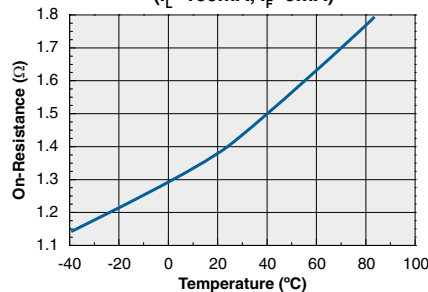

**1-Form-B Relay
Typical I_F for Switch Operation
vs. Temperature
($I_L=100mA$)**

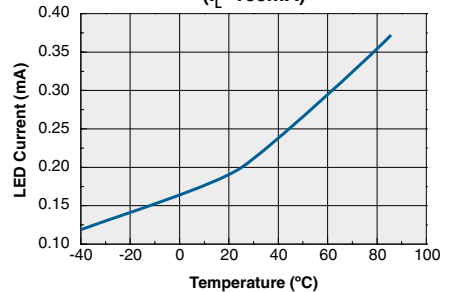

**1-Form-B Relay
Typical Load Voltage vs. Load Current
($T_A=25°C, I_F=0mA$)**

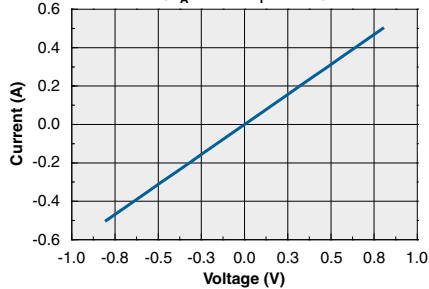

**1-Form-B Relay
Energy Rating Curve**

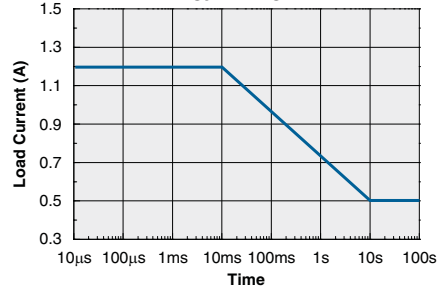

*The Performance data shown in the graphs above is typical of device performance. For guaranteed parameters not indicated in the written specifications, please contact our application department.

Manufacturing Information

Soldering

For proper assembly, the component must be processed in accordance with the current revision of IPC/JEDEC standard J-STD-020. Failure to follow the recommended guidelines may cause permanent damage to the device resulting in impaired performance and/or a reduced lifetime expectancy.

Washing

Clare does not recommend ultrasonic cleaning or the use of chlorinated solvents.



MECHANICAL DIMENSIONS

8-Pin DIP Through-Hole Package

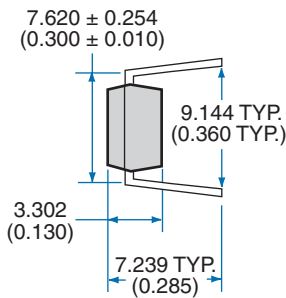
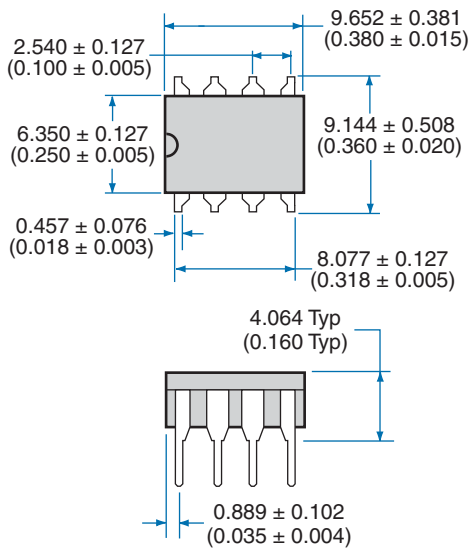

PC Board Pattern

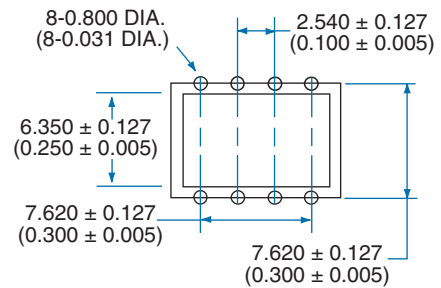

Dimensions
mm
(inches)

8-Pin Surface Mount Package

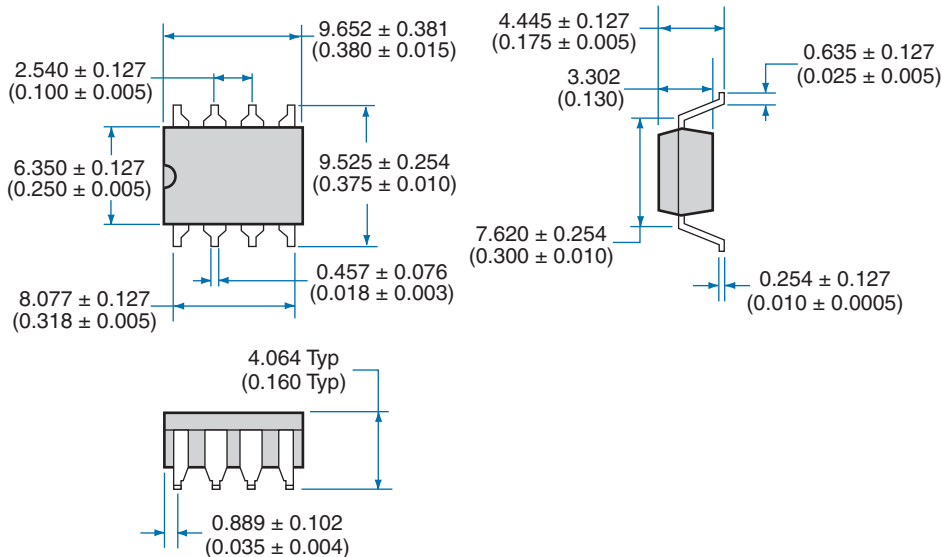

Recommended PCB Land Pattern

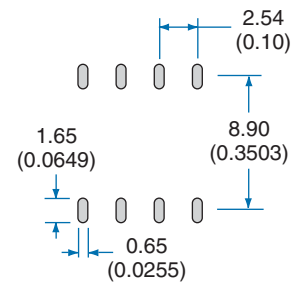

Dimensions
mm
(inches)

MECHANICAL DIMENSIONS

Tape and Reel Packaging for 8-Pin Surface Mount Package

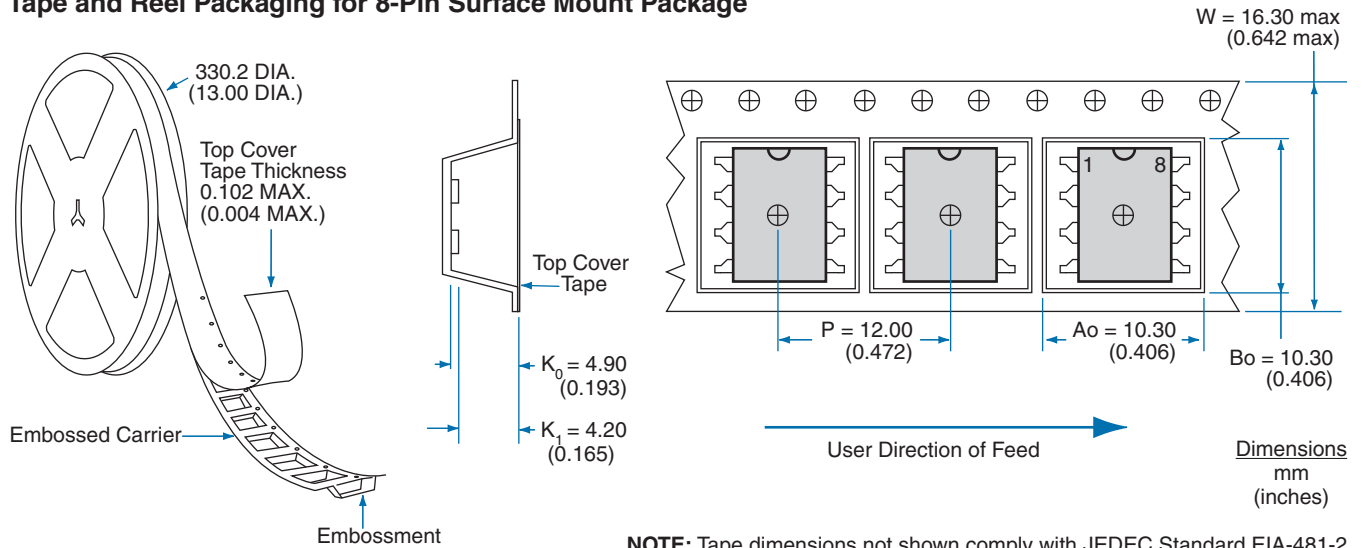

NOTE: Tape dimensions not shown comply with JEDEC Standard EIA-481-2

For additional information please visit our website at: www.clare.com

Clare, Inc. makes no representations or warranties with respect to the accuracy or completeness of the contents of this publication and reserves the right to make changes to specifications and product descriptions at any time without notice. Neither circuit patent licenses nor indemnity are expressed or implied. Except as set forth in Clare's Standard Terms and Conditions of Sale, Clare, Inc. assumes no liability whatsoever, and disclaims any express or implied warranty, relating to its products including, but not limited to, the implied warranty of merchantability, fitness for a particular purpose, or infringement of any intellectual property right.

The products described in this document are not designed, intended, authorized or warranted for use as components in systems intended for surgical implant into the body, or in other applications intended to support or sustain life, or where malfunction of Clare's product may result in direct physical harm, injury, or death to a person or severe property or environmental damage. Clare, Inc. reserves the right to discontinue or make changes to its products at any time without notice.

Specification: DS-LBA716-R01
©Copyright 2008, Clare, Inc.
OptoMOS® is a registered trademark of Clare, Inc.
All rights reserved. Printed in USA.
7/23/08