



FEATURES:

- SMD Package
- Single Output Models
- Low Ripple and Noise
- Industry Standard Pinout
- Input / Output Isolation 1500 & 3000 VDC
- Operating Temperature -40°C to +105°C
- RoHS Compliant
- Continuous Short Circuit Protection

Models Single output



Model	Input Voltage (V)	Output Voltage (V)	Output Current Max / Min (mA)	Isolation (VDC)	Input Current Max No Load (mA)	Max Capacitive Load (µF)	Efficiency (%) (Typ.)
AM1LS-0303S-NZ‡	2.97-3.63	3.3	303 / 30	1500	415 25	220	69
AM1LS-0305S-NZ‡#	2.97-3.63	5	200 / 20	1500	404 25	220	74
AM1LS-0309S-NZ‡	2.97-3.63	9	111 / 12	1500	404 25	220	80
AM1LS-0312S-NZ‡	2.97-3.63	12	84 / 9	1500	404 25	220	80
AM1LS-0315S-NZ‡	2.97-3.63	15	67 / 7	1500	404 25	220	80
AM1LS-0324S-NZ‡	2.97-3.63	24	42 / 4	1500	404 25	220	80
AM1LS-0503SJZ	4.5-5.5	3.3	303 / 30	1500	286 10	2400	74
AM1LS-0505SJZ**	4.5-5.5	5	200 / 20	1500	286 10	2400	82
AM1LS-0509SJZ	4.5-5.5	9	111 / 12	1500	254 20	1000	83
AM1LS-0512SJZ	4.5-5.5	12	84 / 9	1500	254 20	560	83
AM1LS-0515SJZ	4.5-5.5	15	67 / 7	1500	254 30	560	83
AM1LS-0524SJZ	4.5-5.5	24	42 / 4	1500	254 30	220	85
AM1LS-0503S-NZ***	4.5-5.5	3.3	303 / 30	1500	263 20	2400	74
AM1LS-0505S-NZ***	4.5-5.5	5	200 / 20	1500	250 20	2400	82
AM1LS-0509S-NZ***	4.5-5.5	9	111 / 12	1500	250 20	1000	83
AM1LS-0512S-NZ***	4.5-5.5	12	84 / 9	1500	250 20	560	83
AM1LS-0515S-NZ***	4.5-5.5	15	67 / 7	1500	250 20	560	83
AM1LS-0524S-NZ***	4.5-5.5	24	42 / 4	1500	250 20	220	85
AM1LS-1203S-NZ#	10.8-13.2	3.3	303 / 30	1500	111 15	220	75
AM1LS-1205S-NZ#	10.8-13.2	5	200 / 20	1500	104 15	220	80
AM1LS-1209S-NZ#	10.8-13.2	9	111 / 12	1500	104 15	220	80
AM1LS-1212S-NZ#	10.8-13.2	12	84 / 9	1500	103 15	220	81
AM1LS-1215S-NZ#	10.8-13.2	15	67 / 7	1500	103 15	220	81
AM1LS-1224S-NZ	10.8-13.2	24	42 / 4	1500	103 15	220	81
AM1LS-1505S-NZ	13.5-16.5	5	200 / 20	1500	82 10	220	80
AM1LS-1509S-NZ	13.5-16.5	9	111 / 12	1500	82 10	220	80
AM1LS-1515S-NZ	13.5-16.5	15	67 / 7	1500	82 10	220	81
AM1LS-2403S-NZ‡	21.6-26.4	3.3	303 / 30	1500	52 7	220	71
AM1LS-2405S-NZ‡#	21.6-26.4	5	200 / 20	1500	52 7	220	80
AM1LS-2409S-NZ‡#	21.6-26.4	9	111 / 12	1500	52 7	220	80
AM1LS-2412S-NZ‡	21.6-26.4	12	84 / 9	1500	52 7	220	80
AM1LS-2415S-NZ‡#	21.6-26.4	15	67 / 7	1500	51 7	220	81
AM1LS-2424S-NZ‡#	21.6-26.4	24	42 / 4	1500	51 7	220	81
AM1LS-0303SH30-NZ‡	2.97-3.63	3.3	303 / 30	3000	415 25	220	73
AM1LS-0305SH30-NZ‡#	2.97-3.63	5	200 / 20	3000	388 25	220	78
AM1LS-0503SH30-NZ***	4.5-5.5	3.3	303 / 30	3000	263 20	2400	74
AM1LS-0505SH30-NZ***	4.5-5.5	5	200 / 20	3000	250 20	2400	82
AM1LS-0509SH30-NZ***	4.5-5.5	9	111 / 12	3000	250 20	1000	83
AM1LS-0512SH30-NZ***	4.5-5.5	12	84 / 9	3000	250 20	560	83
AM1LS-0515SH30-NZ***	4.5-5.5	15	67 / 7	3000	250 20	560	83
AM1LS-0524SH30-NZ***	4.5-5.5	24	42 / 4	3000	250 20	220	85
AM1LS-1203SH30-NZ#	10.8-13.2	3.3	303 / 30	3000	111 15	220	75
AM1LS-1205SH30-NZ#	10.8-13.2	5	200 / 20	3000	104 15	220	80
AM1LS-1209SH30-NZ#	10.8-13.2	9	111 / 12	3000	104 15	220	80
AM1LS-1212SH30-NZ#	10.8-13.2	12	84 / 9	3000	103 15	220	81

AM1LS-1215SH30-NZ#	10.8-13.2	15	67 / 7	3000	103	15	220	81
AM1LS-1224SH30-NZ	10.8-13.2	24	42 / 4	3000	103	15	220	81
AM1LS-1515SH30-NZ	13.5-16.5	15	67 / 7	3000	82	10	220	80
AM1LS-2405SH30-NZ‡#	21.6-26.4	5	200 / 20	3000	52	7	220	80
AM1LS-2409SH30-NZ‡#	21.6-26.4	9	111 / 12	3000	52	7	220	80
AM1LS-2415SH30-NZ‡#	21.6-26.4	15	67 / 7	3000	52	7	220	80
AM1LS-2424SH30-NZ‡#	21.6-26.4	24	42 / 4	3000	52	7	220	80

Models

Dual output

Model	Input Voltage (V)	Output Voltage (V)	Output Current Max / Min (mA)	Isolation (VDC)	Input Current Max No Load (mA)		Max Capacitive Load(μF)	Efficiency (%)
AM1LS-0305D-NZ‡	2.97-3.63	±5	±100 / ±10	1500	415	25	100	78
AM1LS-0312D-NZ‡	2.97-3.63	±12	±42 / ±5	1500	388	25	100	80
AM1LS-0315D-NZ‡	2.97-3.63	±15	±33 / ±3	1500	263	20	100	80
AM1LS-0505D-NZ##**	4.5-5.5	±5	±100 / ±10	1500	250	20	1200	82
AM1LS-0509D-NZ##**	4.5-5.5	±9	±56 / ±6	1500	250	20	470	82
AM1LS-0512D-NZ##**	4.5-5.5	±12	±42 / ±5	1500	250	20	220	83
AM1LS-0515D-NZ##**	4.5-5.5	±15	±33 / ±3	1500	250	20	220	83
AM1LS-0524D-NZ##**	4.5-5.5	±24	±21 / ±3	1500	254	30	100	85
AM1LS-1205D-NZ#	10.8-13.2	±5	±100 / ±10	1500	111	15	100	75
AM1LS-1209D-NZ#	10.8-13.2	±9	±56 / ±6	1500	104	15	100	80
AM1LS-1212D-NZ#	10.8-13.2	±12	±42 / ±5	1500	104	15	100	80
AM1LS-1215D-NZ#	10.8-13.2	±15	±33 / ±3	1500	103	15	100	81
AM1LS-1224D-NZ#	10.8-13.2	±24	±21 / ±2	1500	103	15	100	81
AM1LS-1515D-NZ	13.5-16.5	±15	±33 / ±3	1500	103	15	100	81
AM1LS-2405D-NZ‡#	21.6-26.4	±5	±100 / ±10	1500	83	12	100	82
AM1LS-2409D-NZ‡#	21.6-26.4	±9	±56 / ±6	1500	52	7	100	82
AM1LS-2412D-NZ‡#	21.6-26.4	±12	±42 / ±5	1500	52	7	100	82
AM1LS-2415D-NZ‡#	21.6-26.4	±15	±33 / ±3	1500	51	7	100	82
AM1LS-2424D-NZ‡#	21.6-26.4	±24	±21 / ±2	1500	51	7	100	82
AM1LS-0305DH30-NZ‡	2.97-3.63	±5	±100 / ±10	3000	389	25	100	76
AM1LS-0312DH30-NZ‡	2.97-3.63	±12	±42 / ±5	3000	389	25	100	77
AM1LS-0505DH30-NZ##**	4.5-5.5	±5	±100 / ±10	3000	250	20	1200	82
AM1LS-0509DH30-NZ##**	4.5-5.5	±9	±56 / ±6	3000	250	20	470	83
AM1LS-0512DH30-NZ##**	4.5-5.5	±12	±42 / ±5	3000	250	20	220	83
AM1LS-0515DH30-NZ##**	4.5-5.5	±15	±34 / ±4	3000	250	20	220	83
AM1LS-0524DH30-NZ##**	4.5-5.5	±24	±21 / ±3	3000	254	30	100	85
AM1LS-1205DH30-NZ#	10.8-13.2	±5	±100 / ±10	3000	111	15	100	80
AM1LS-1209DH30-NZ#	10.8-13.2	±9	±56 / ±6	3000	104	15	100	80
AM1LS-1212DH30-NZ#	10.8-13.2	±12	±42 / ±5	3000	104	15	100	81
AM1LS-1215DH30-NZ#	10.8-13.2	±15	±33 / ±3	3000	103	15	100	81
AM1LS-1224DH30-NZ#	10.8-13.2	±24	±21 / ±2	3000	103	15	100	81
AM1LS-1515DH30-NZ	13.5-16.5	±15	±33 / ±3	3000	83	12	100	81
AM1LS-2405DH30-NZ‡#	21.6-26.4	±5	±100 / ±10	3000	82	10	100	82
AM1LS-2409DH30-NZ‡#	21.6-26.4	±9	±56 / ±6	3000	52	7	100	82
AM1LS-2412DH30-NZ‡#	21.6-26.4	±12	±42 / ±5	3000	52	7	100	82
AM1LS-2415DH30-NZ‡#	21.6-26.4	±15	±33 / ±3	3000	51	7	100	82
AM1LS-2424DH30-NZ‡#	21.6-26.4	±24	±21 / ±2	3000	51	7	100	82

‡ With Momentary short circuit protection of 1 second

NOTE 1: Add suffix "TR" to a part number when ordering in tape and reel package

NOTE: All specifications in this datasheet are measured at an ambient temperature of 25°C, humidity<75%, nominal input voltage and at rated output load unless otherwise specified.

Input Specifications

Parameters	Nominal	Typical	Maximum	Units
Voltage Range	3	2.97-3.63		VDC
	5	4.5-5.5		
	12	10.8-13.2		
	15	13.5-16.5		
	24	21.6-26.4		
Absolute Max Input Voltage (1 sec max)	3 Vin		5	VDC
	5 Vin		9	
	12 Vin		18	
	15 Vin		21	
24 Vin		30		
Filter	Capacitor			

Isolation Specifications

Parameters	Conditions	Typical	Maximum	Units
Tested I/O Voltage	60 sec	1500 / 3000		VDC
Resistance	500VDC	>1000		MOhm
Capacitance		20		pF

Output Specifications

Parameters	Conditions	Typical	Maximum	Units
Voltage Accuracy	100% load (see tolerance chart)	±5		%
Short Circuit Protection	Continuous, unless marked with ‡			
Short Circuit Restart	Auto-Recovery			
Line Voltage Regulation	For ±1% of Vin, 3.3V output models only		±1.5	% of Vin
	For ±1% of Vin, others		±1.2	
Load Voltage Regulation (10% - 100% Load)	3.3V	18	20	%
	5V	12	15	
	6V	10	13	
	9V	8	10	
	12V	7	10	
	15V	6	10	
Temperature Coefficient	100% load, 5V input models	±0.02		% / °C
	100% load, Others	±0.03		
Ripple & Noise	5V input, 24V output	50	100	mV p-p
	5V input, other models	30	75	
	Others	60	150	

General Specifications

Parameters	Conditions	Typical	Maximum	Units
Switching frequency	100% load, 5V input models	270		KHz
	100% load, others	100	300	
Operating temperature	With derating above +100	-40 to +105		°C
Storage temperature		-55 to +125		°C
Cooling	Free air convection			
Storage Humidity	Non-condensing		95	% RH
Moisture Sensitivity Level (MSL)	IPC/JEDEC J-STD-020D.1 (5Vin models only)	Level 1		
Case material	Flame retardant plastic (UL94-V0)			
Weight	Single 1.5(5Vin models 1.4)			g
	Dual 1.8(5Vin models 1.4)			
Dimensions (L x W x H)	5V Input Single Output Models	0.52 x 0.45 x 0.28inches (13.20 x 11.40 x 7.25mm)		
	Other Single Output Models	0.50 x 0.44 x 0.28inches (12.70 x 11.20 x 7.25mm)		
	5V Input Dual Output Models	0.60 x 0.45 x 0.28inches (15.24 x 11.40 x 7.25mm)		
	Other Dual Output Models	0.60 x 0.44 x 0.28inches (15.24 x 11.20 x 7.25mm)		
MTBF	>3500Khrs (MIL-HDBK -217F, Ground Benign, t=+25°C)			
Maximum soldering temperature	Manual soldering 1.5mm from case for 10 sec		300	°C
	Reflow maximum duration ≤60s at over 217°C		245	
Maximum case temperature		130		°C

Safety Specifications

Parameters			
Agency approvals	cULus		
Standards	Information technology Equipment		UL 60950-1 (The models marked with # only) UL 62368 (The models marked with ** only)
	EMI - Conducted and radiated emission	5V input	CISPR32/EN55032, class B (with the recommended EMC circuit for 5Vin models)
		Others	EN55022, class B (with the recommended EMC circuit)
	Electrostatic Discharge Immunity	5V input	IEC 61000-4-2, Contact $\pm 4\text{kV}$, Air $\pm 8\text{kV}$, Criteria B
Others		IEC 61000-4-2, Contact $\pm 8\text{kV}$, Criteria B	

Pin Out Specifications and Dimensions for 3.3V, 12V, 15V, 24V Input Models##

Pin	Single
1	- V Input
2	+ V Input
3	No Pin
4	-V Output
5	+V Output
6	No Pin
7	No Pin
8	N.C.

Single Output Models

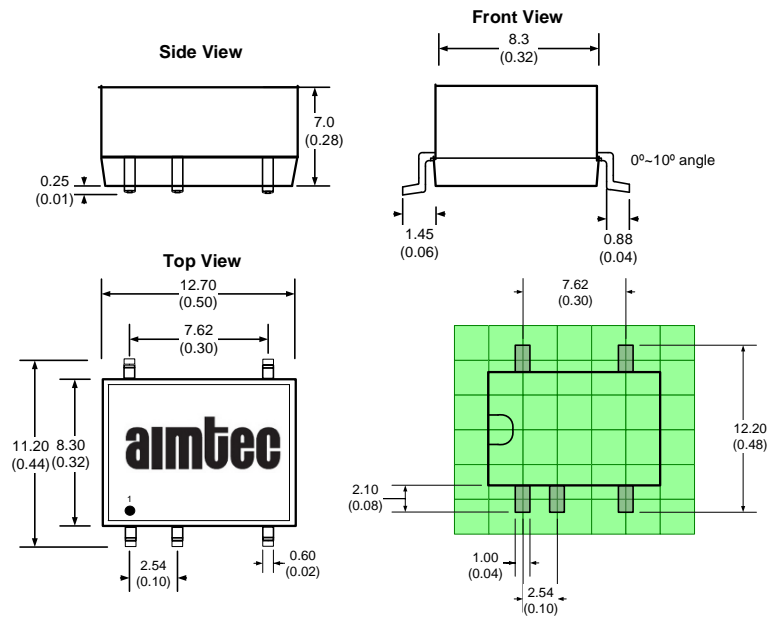

Pin	Dual Output Models
1	-V Input
2	+V Input
3	No Pin
4	Common
5	-V Output
6	No Pin
7	+V Output
8	No Pin
9	No Pin
10	N.C.

Dual Output Models

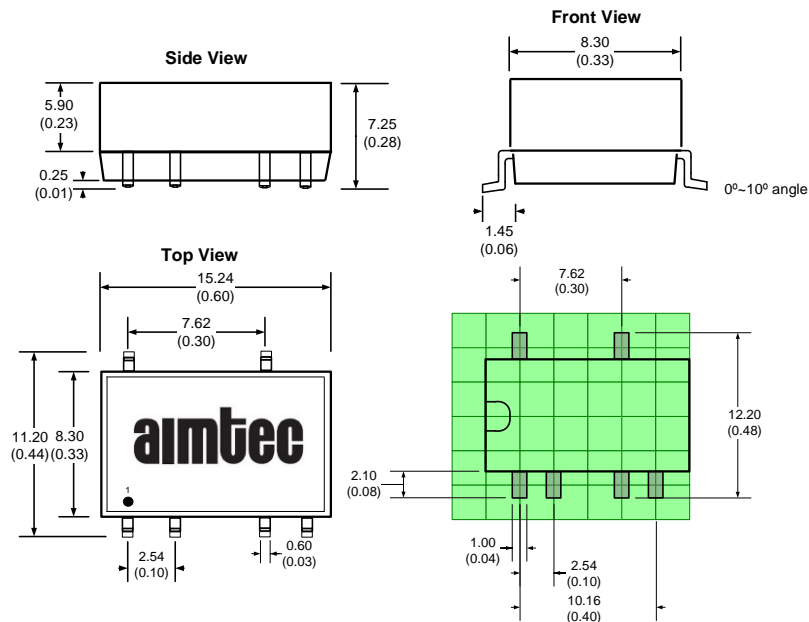

Pin Out Specifications and Dimensions for 5V Input Models

Pin	Single
1	- V Input
2	+ V Input
3	No Pin
4	-V Output
5	+V Output
6	No Pin
7	No Pin
8	N.C.

5V Input Single Output Models

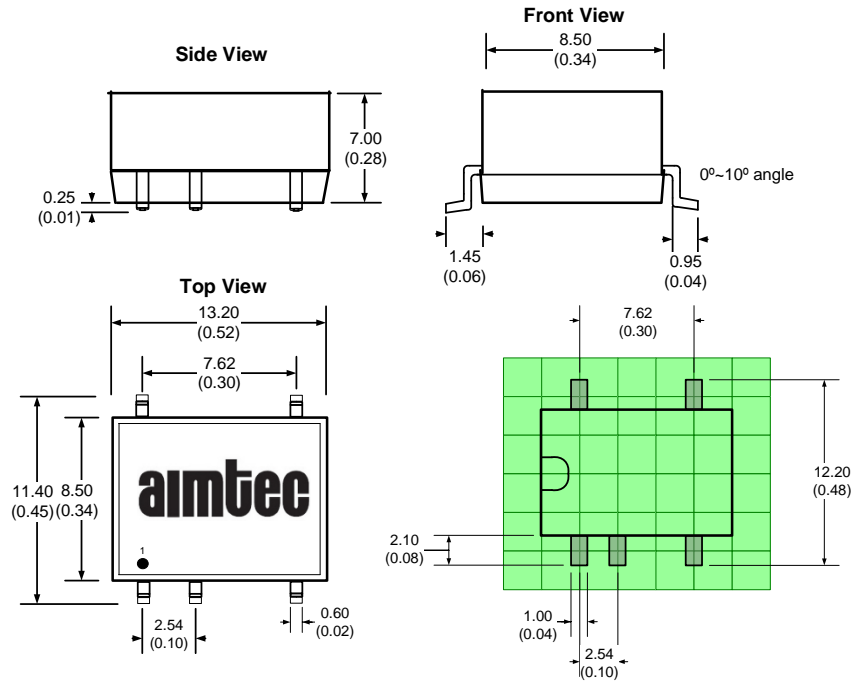

Pin	Dual Output Models
1	-V Input
2	+V Input
3	No Pin
4	Common
5	-V Output
6	No Pin
7	+V Output
8	No Pin
9	No Pin
10	N.C.

5V Input Dual Output Models

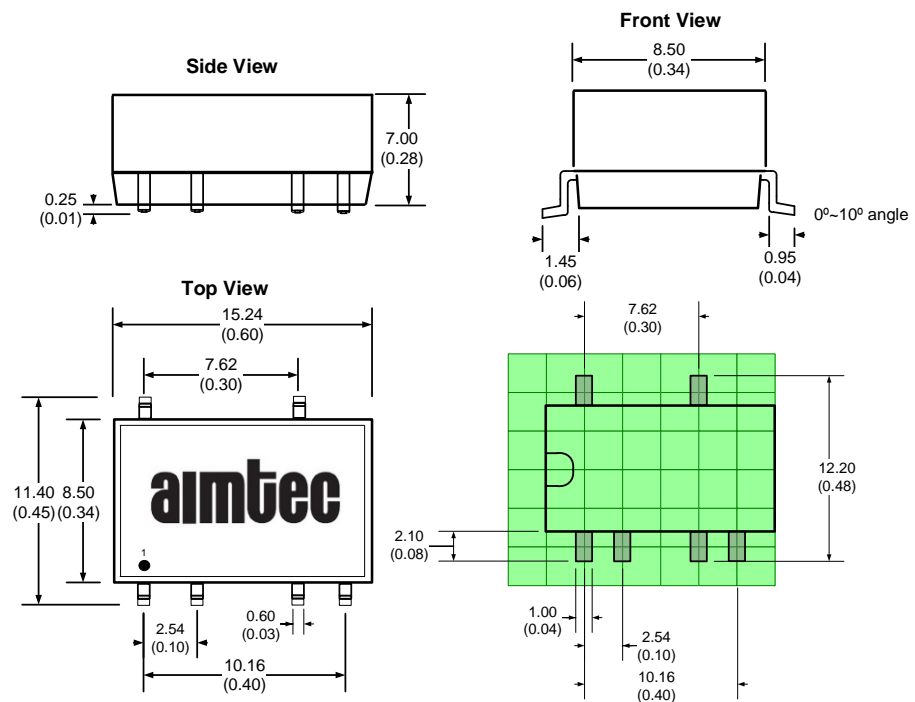

Typical Application Circuits

Capacitor selection Table

Vin	C1	Single VDC	C2	Dual VDC	C2/C3
3.3	4.7 μ F	3.3 V	10 μ F	\pm 3.3	4.7 μ F
5	4.7 μ F	5V/6V	10 μ F	\pm 5V	4.7 μ F
		9 V	4.7 μ F	\pm 9V	2.2 μ F
12	2.2 μ F	12 V	2.2 μ F	\pm 12 V	1 μ F
15	2.2 μ F	15 V	1 μ F	\pm 15 V	1 μ F
24	1 μ F	24V	0.47 μ F	\pm 24 V	1 μ F

- 1) Ensure output load of Min 10%, or specifications may not be met
- 2) Under normal operation, there is no protection for overload condition
- 3) Converter may exhibit start up delay if capacitive load exceeds recommended
- 4) Ceramic or electrolytic type capacitors are recommended, tantalum type may damage converter
- 5) Parallel connections, or hot swapping is not recommended

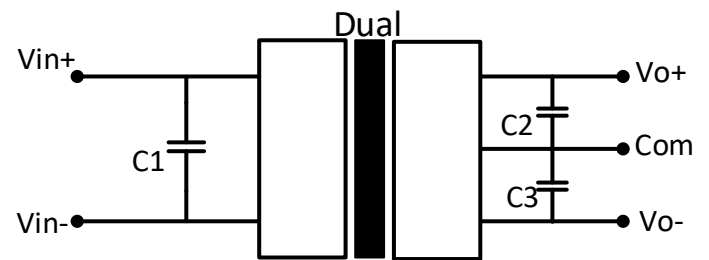
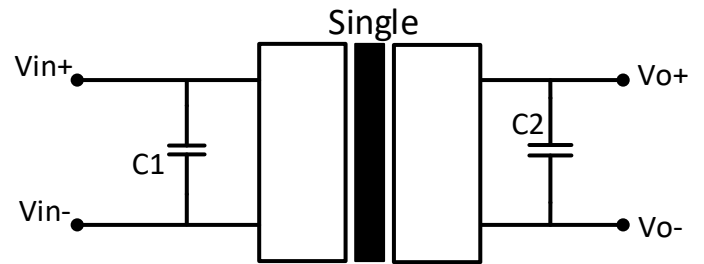

EMI Recommended Circuit for 5V input models (Class B)

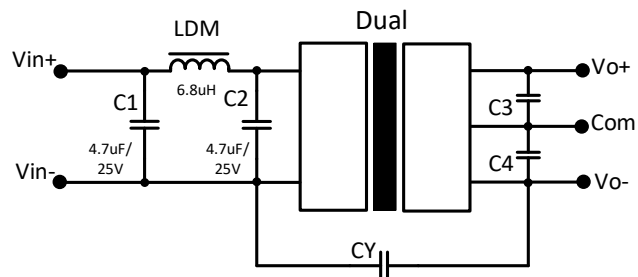
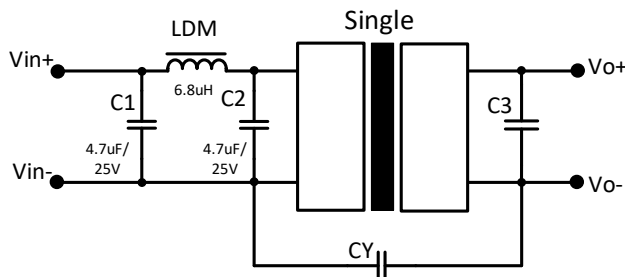

Vout	CY
3.3	-
5	-
9	-
12	1nF/2KVDC for 1.5KVDC isolation models 1nF/4KVDC for 3KVDC isolation models
15	
24	

EMI Recommended Circuit for other input models (Class B)

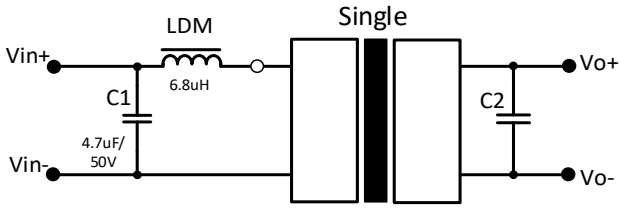

Input Reflected Ripple Current Test Circuit

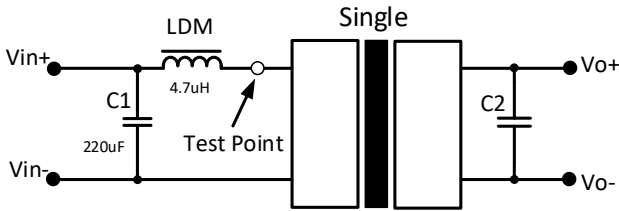

Load Accuracy Tolerance Graph

For AM1LS-0503S-NZ, AM1LS-0503SH30-NZ and AM1LS-0503SJZ

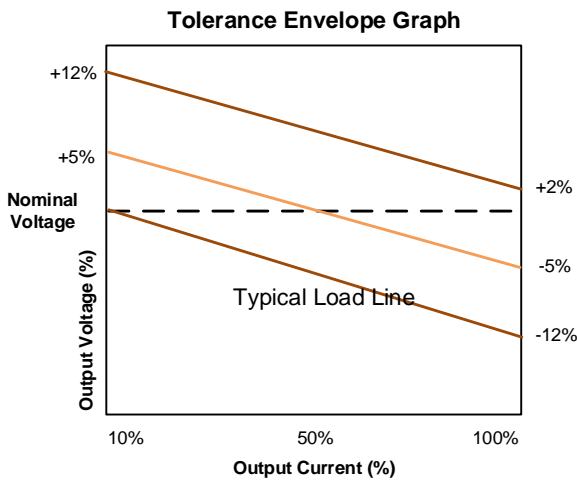

For other models

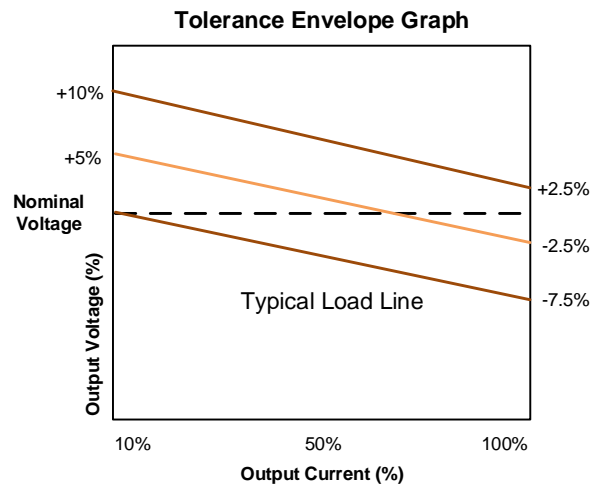

Derating

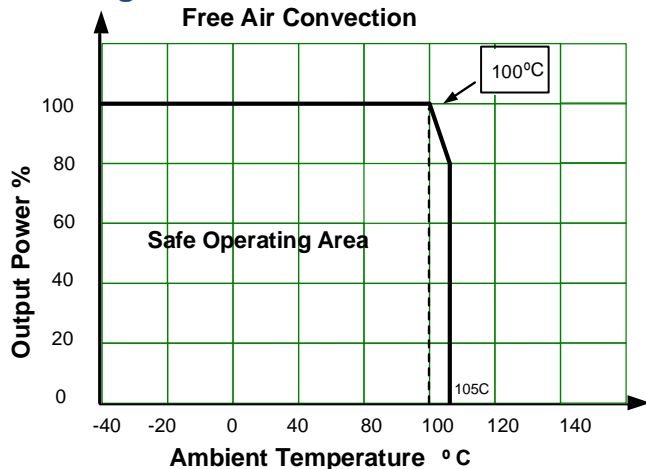

Typical Efficiency vs. Loading

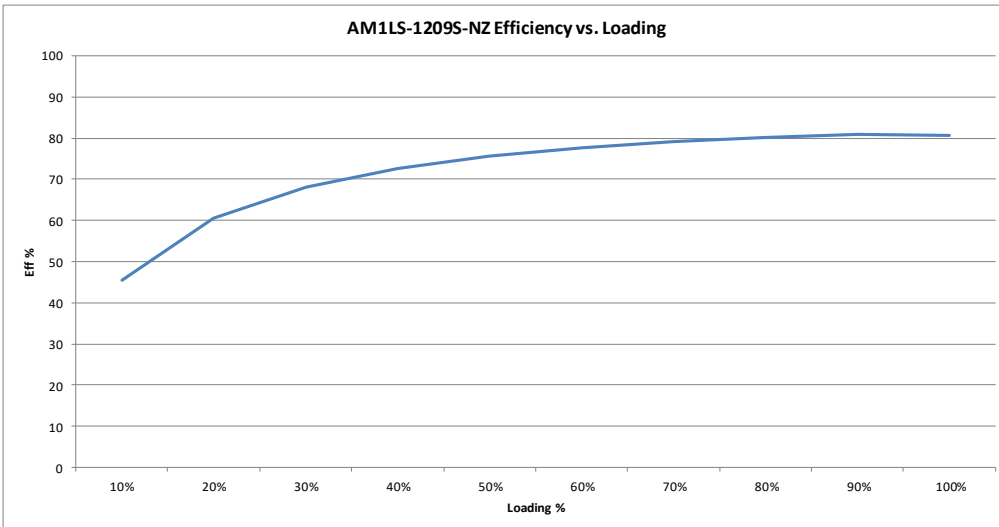
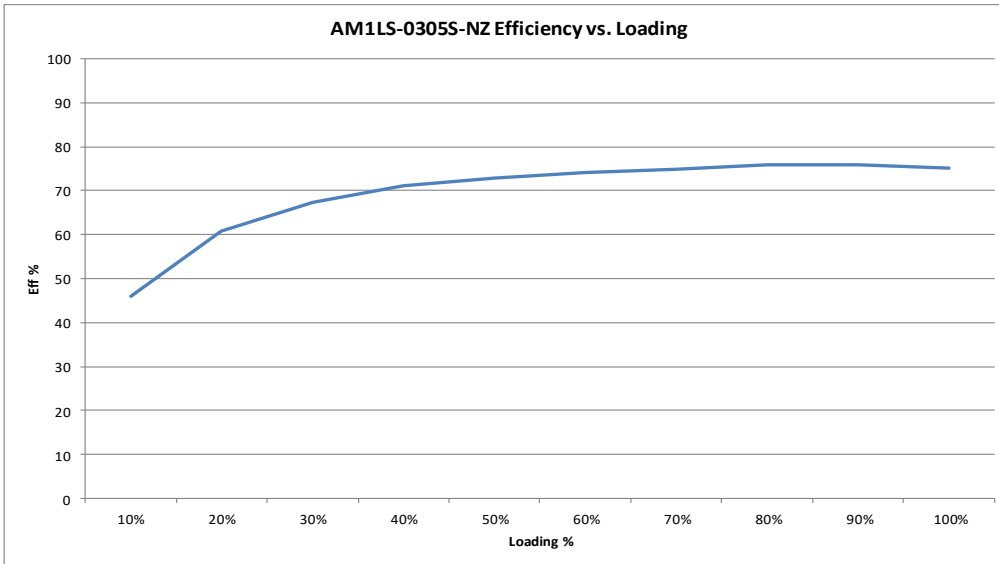

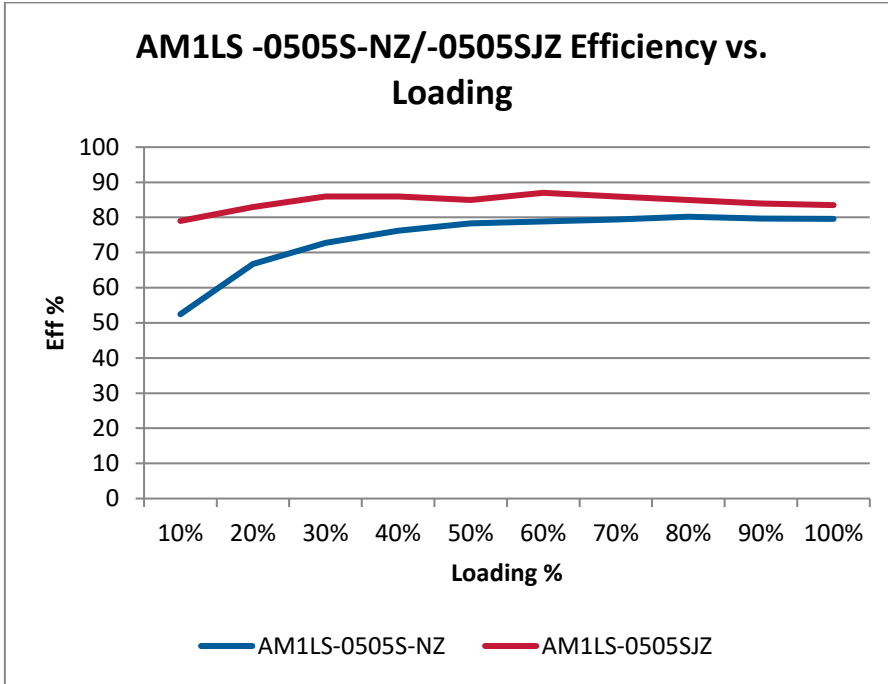

NOTE: **1.** Datasheets are updated as needed and as such, specifications are subject to change without notice. Once printed or downloaded, datasheets are no longer controlled by Aimtec; refer to www.aimtec.com for the most current product specifications. **2.** Product labels shown, including safety agency certifications on labels, may vary based on the date manufactured. **3.** Mechanical drawings and specifications are for reference only. **4.** All specifications are measured at an ambient temperature of 25°C, humidity<75%, nominal input voltage and at rated output load unless otherwise specified. **5.** Aimtec may not have conducted destructive testing or chemical analysis on all internal components and chemicals at the time of publishing this document. CAS numbers and other limited information are considered proprietary and may not be available for release. **6.** This product is not designed for use in critical life support systems, equipment used in hazardous environments, nuclear control systems or other such applications which necessitate specific safety and regulatory standards other the ones listed in this datasheet. **7.** Warranty is in accordance with Aimtec’s standard Terms of Sale available at www.aimtec.com.