



FEATURES:

- RoHS compliant
- High efficiency up to 82%
- Low profile plastic package
- 7 pin SIP package
- Operating temperature -40°C to + 105°C
- Continuous short circuit protection
- Pin compatible with multiple manufacturers
- Up to 3000VDC Isolation

Models Single output



Model	Input Voltage (V)	Output Voltage (V)	Output Current max (mA)	Isolation (VDC)	Input Current Full Load No Load (mA)		Max. Capacitive Load (µF)	Efficiency (%)
AM1DS-0303S-NZ‡*	3.0-3.6	3.3	303	1500	426	30	220	72
AM1DS-0305S-NZ‡*	3.0-3.6	5	200	1500	426	30	220	78
AM1DS-0505S-NZ	4.5-5.5	5	200	1500	281	25	220	80
AM1DS-0503SJZ*	4.5-5.5	3,3	303	1500	270	5	2400	74
AM1DS-0505SJZ	4.5-5.5	5	200	1500	270	5	2400	82
AM1DS-0509SJZ*	4.5-5.5	9	111	1500	241	12	1000	83
AM1DS-0512SJZ*	4.5-5.5	12	84	1500	241	12	560	83
AM1DS-0515SJZ*	4.5-5.5	15	67	1500	241	18	560	83
AM1DS-0524SJZ*	4.5-5.5	24	42	1500	241	18	220	85
AM1DS-0509S-NZ	4.5-5.5	9	111	1500	281	25	220	80
AM1DS-0512S-NZ	4.5-5.5	12	84	1500	281	25	220	80
AM1DS-0515S-NZ	4.5-5.5	15	67	1500	281	25	220	80
AM1DS-0524S-NZ‡	4.5-5.5	24	42	1500	281	25	220	80
AM1DS-1205S-NZ	10.8-13.2	5	200	1500	106	15	220	80
AM1DS-1209S-NZ	10.8-13.2	9	111	1500	106	15	220	80
AM1DS-1212S-NZ	10.8-13.2	12	84	1500	106	15	220	80
AM1DS-1215S-NZ	10.8-13.2	15	67	1500	106	15	220	80
AM1DS-1515S-NZ*	13.5-16.5	15	67	1500	84	10	220	80
AM1DS-2403S-NZ‡*	21.6-26.4	3.3	303	1500	54	7	220	74
AM1DS-2405S-NZ‡	21.6-26.4	5	200	1500	54	7	220	80
AM1DS-2412S-NZ‡	21.6-26.4	12	84	1500	54	7	220	80
AM1DS-2415S-NZ‡	21.6-26.4	15	67	1500	54	7	220	80
AM1DS-2424S-NZ‡	21.6-26.4	24	42	1500	54	7	220	80
AM1DS-0305SH30-NZ‡*	3.0-3.6	5	200	3000	415	25	220	78
AM1DS-0503SH30JZ*	4.5-5.5	3.3	303	3000	270	5	2400	74
AM1DS-0505SH30JZ*	4.5-5.5	5	200	3000	270	5	2400	82
AM1DS-0509SH30JZ*	4.5-5.5	9	111	3000	241	12	1000	83
AM1DS-0512SH30JZ*	4.5-5.5	12	84	3000	241	12	560	83
AM1DS-0515SH30JZ*	4.5-5.5	15	67	3000	241	18	560	83
AM1DS-0524SH30JZ*	4.5-5.5	24	42	3000	241	18	220	85
AM1DS-0505SH30-NZ	4.5-5.5	5	200	3000	274	20	220	80
AM1DS-0509SH30-NZ	4.5-5.5	9	111	3000	274	20	220	80
AM1DS-0512SH30-NZ	4.5-5.5	12	83	3000	274	20	220	80
AM1DS-0515SH30-NZ	4.5-5.5	15	67	3000	274	20	220	81
AM1DS-0524SH30-NZ‡	4.5-5.5	24	42	3000	274	20	220	81
AM1DS-1205SH30-NZ	10.8-13.2	5	200	3000	114	15	220	80
AM1DS-1209SH30-NZ	10.8-13.2	9	111	3000	114	15	220	80
AM1DS-1212SH30-NZ	10.8-13.2	12	83	3000	114	15	220	80
AM1DS-1215SH30-NZ	10.8-13.2	15	67	3000	114	15	220	81
AM1DS-1224SH30-NZ	10.8-13.2	24	42	3000	114	15	220	81
AM1DS-2405SH30-NZ‡	21.6-26.4	5	200	3000	58	7	220	79
AM1DS-2409SH30-NZ‡	21.6-26.4	9	111	3000	58	7	200	80
AM1DS-2412SH30-NZ‡	21.6-26.4	12	83	3000	58	7	220	81
AM1DS-2415SH30-NZ‡	21.6-26.4	15	67	3000	58	7	220	81
AM1DS-2424SH30-NZ‡	21.6-26.4	24	42	3000	58	7	220	81

Models
Dual output

Model	Input Voltage (V)	Output Voltage (V)	Output Current max (Ma)	Isolation (VDC)	Input Current Full Load No Load (mA)		Max. Capacitive Load (µF)	Efficiency (%)
AM1DS-0305D-NZ*	2.97-3.63	±5	±100	1500	274	20	±100	78
AM1DS-0312D-NZ*	2.97-3.63	±12	±42	1500	248	20	±100	78
AM1DS-0505D-NZ	4.5-5.5	±5	±100	1500	281	25	±100	80
AM1DS-0503DJZ*	4.5-5.5	±3.3	±152	1500	270	5	±1200	74
AM1DS-0505DJZ	4.5-5.5	±5	±100	1500	270	5	±1200	82
AM1DS-0509DJZ*	4.5-5.5	±9	±56	1500	241	12	±470	83
AM1DS-0512DJZ*	4.5-5.5	±12	±42	1500	241	12	±220	83
AM1DS-0515DJZ*	4.5-5.5	±15	±34	1500	241	18	±220	83
AM1DS-0524DJZ*	4.5-5.5	±24	±21	1500	241	18	±100	85
AM1DS-0509D-NZ	4.5-5.5	±9	±56	1500	281	25	±100	80
AM1DS-0512D-NZ	4.5-5.5	±12	±42	1500	281	25	±100	80
AM1DS-0515D-NZ	4.5-5.5	±15	±34	1500	281	25	±100	80
AM1DS-0524D-NZ‡	4.5-5.5	±24	±21	1500	281	25	±100	80
AM1DS-1205D-NZ	10.8-13.2	±5	±100	1500	106	15	±100	80
AM1DS-1212D-NZ	10.8-13.2	±12	±42	1500	106	15	±100	80
AM1DS-1215D-NZ	10.8-13.2	±15	±34	1500	106	15	±100	80
AM1DS-1512D-NZ*	13.5-16.5	±12	±42	1500	84	10	±100	80
AM1DS-1515D-NZ	13.5-16.5	±15	±34	1500	84	10	±100	80
AM1DS-2405D-NZ‡	21.6-26.4	±5	±100	1500	54	7	±100	80
AM1DS-2412D-NZ‡	21.6-26.4	±12	±42	1500	54	7	±100	80
AM1DS-2415D-NZ‡	21.6-26.4	±15	±34	1500	54	7	±100	80
AM1DS-2424D-NZ‡	21.6-26.4	±24	±21	1500	54	7	±100	80
AM1DS-0503DH30JZ*	4.5-5.5	±3.3	±152	3000	270	5	±1200	74
AM1DS-0505DH30JZ	4.5-5.5	±5	±100	3000	270	5	±1200	82
AM1DS-0509DH30JZ	4.5-5.5	±9	±56	3000	241	12	±470	83
AM1DS-0512DH30JZ	4.5-5.5	±12	±42	3000	241	12	±220	83
AM1DS-0515DH30JZ	4.5-5.5	±15	±34	3000	241	18	±220	83
AM1DS-0524DH30JZ	4.5-5.5	±24	±21	3000	241	18	±100	85
AM1DS-0505DH30-NZ	4.5-5.5	±5	±100	3000	274	20	±100	80
AM1DS-0509DH30-NZ	4.5-5.5	±9	±56	3000	274	20	±100	80
AM1DS-0512DH30-NZ	4.5-5.5	±12	±42	3000	274	20	±100	80
AM1DS-0515DH30-NZ	4.5-5.5	±15	±33	3000	274	20	±100	81
AM1DS-0524DH30-NZ‡	4.5-5.5	±24	±21	3000	274	20	±100	81
AM1DS-1205DH30-NZ	10.8-13.2	±5	±100	3000	114	15	±100	80
AM1DS-1212DH30-NZ	10.8-13.2	±12	±42	3000	114	15	±100	81
AM1DS-1215DH30-NZ	10.8-13.2	±15	±34	3000	114	15	±100	81
AM1DS-1224DH30-NZ	10.8-13.2	±24	±21	3000	114	15	±100	80
AM1DS-2405DH30-NZ‡	21.6-26.4	±5	±100	3000	58	7	±100	80
AM1DS-2409DH30-NZ‡	21.6-26.4	±9	±56	3000	58	7	±100	80
AM1DS-2412DH30-NZ‡	21.6-26.4	±12	±42	3000	58	7	±100	81
AM1DS-2415DH30-NZ‡	21.6-26.4	±15	±33	3000	58	7	±100	79
AM1DS-2424DH30-NZ‡	21.6-26.4	±24	±21	3000	58	7	±100	80

‡ With Momentary short circuit protection of 1 second
* Reference in the Safety Table

NOTE: All specifications in this datasheet are measured at an ambient temperature of 25°C, humidity<75%, nominal input voltage and at rated output load unless otherwise specified.

Input Specifications

Parameters	Nominal	Typical	Maximum	Units
Voltage range	3.3	2.97–3.63 or 3.0-3.6		VDC
	5	4.5-5.5		
	12	10.8-13.2		
	15	13.5-16.5		
	24	21.6-26.4		
Filter	Capacitor			
Absolute Maximum Rating	3.3		5	VDC
	5		9	
	12		18	
	15		21	
	24		30	
Peak Input Voltage time			1	s
No Load Input Current	3.3	30	70	mA
	5	25	60	
	12	15	50	
	15	10	35	
	24	7	30	
Input no load current for part numbers with suffix JZ	3.3 & 5VDC o/p	5	10	mA
	9 & 12VDC o/p	12	20	
	15 & 24VDC o/p	18	30	

Isolation Specifications

Parameters	Conditions	Typical	Rated	Units
Tested I/O voltage	60 sec		1500, 3000	VDC
Resistance		> 1000		MOhm
Capacitance		20		pF

Output Specifications

Parameters	Conditions	Typical	Maximum	Units	
Voltage accuracy	See voltage accuracy graph			%	
Short Circuit protection	Continuous, unless marked with ‡				
Short circuit restart	Auto recovery				
Line voltage regulation	For 1% change of Vin	3.3V output	1.5	% of Vin	
		others	1.2		
Load voltage regulation	load 10~100%	3.3V output	18	%	
		5V output	12		
		9V output	9		
		12V output	8		
		15V output	7		
		24V output	6		
	load 10~100% for JZ models	3.3V output	15		20
		5V output	10		15
		9V output	8		10
		12V output	7		10
		15V output	6		10
Temperature coefficient	Full load		±0.03	% / °C	
	Full load for JZ models		±0.02		
Ripple & Noise	20MHz Bandwidth for 3KV isolation models	3.3, 5, 12V output	30	mV p-p	
		15, 24V output	60		
	20MHz Bandwidth for JZ models	24V output	30		75
		Others	50		100
20MHz Bandwidth for 1.5KV isolation models		60	150		

General Specifications

Parameters	Conditions	Typical	Maximum	Units
Switching frequency	100% load	100		KHz
	100% load for JZ models	270		
Operating temperature	With derating above 85°C	-40 to +105		°C
Storage temperature		-55 to +125		°C
Maximum case temperature			130	°C
Cooling		Free air convection		
Humidity	Non condensing		95	% RH
Case material	Non-conductive black plastic (UL94V-0 rated)			
Weight	Others	2.4		g
	for JZ models	2.1		
Dimensions (L x W x H)	Others	0.77 x 0.24 x 0.37inches	19.50 x 6.00 x 9.30mm	
	for JZ models	0.77 x 0.24 x 0.4inches	19.65 x 6.00 x 10.16mm	
MTBF	>3,500,000hrs (MIL-HDBK -217F, Ground Benign, t=+25°C)			
Maximum soldering temperature	1.5 mm from case for 10sec		300	°C

Safety Specifications

Parameters		
Agency approvals	cULus (except the models marked with *)	
Standards	Information technology Equipment	UL 60950-1 UL 62368-1 for JZ models only
	EMI - Conducted and radiated emission	EN55032 Class B with recommend circuit
	Electrostatic Discharge Immunity	IEC 61000-4-2 Contact ±6KV Criteria B for single output models
		IEC 61000-4-2 Contact ±8KV Criteria B for dual output models IEC 61000-4-2 Contact ±4kV, Air ±8kV Criteria B for JZ models

Voltage Accuracy Graph

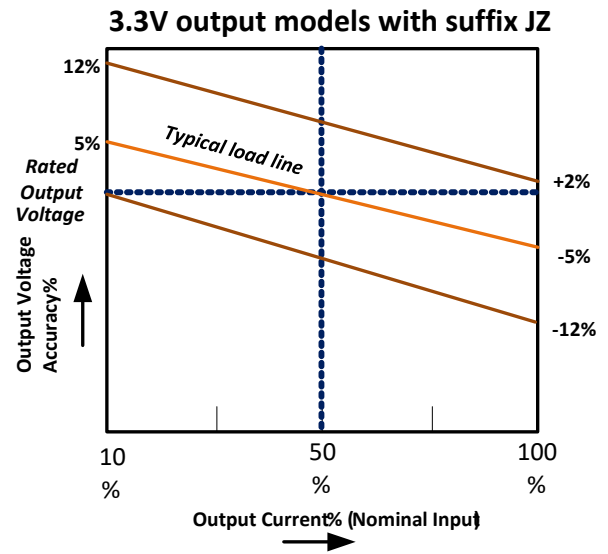
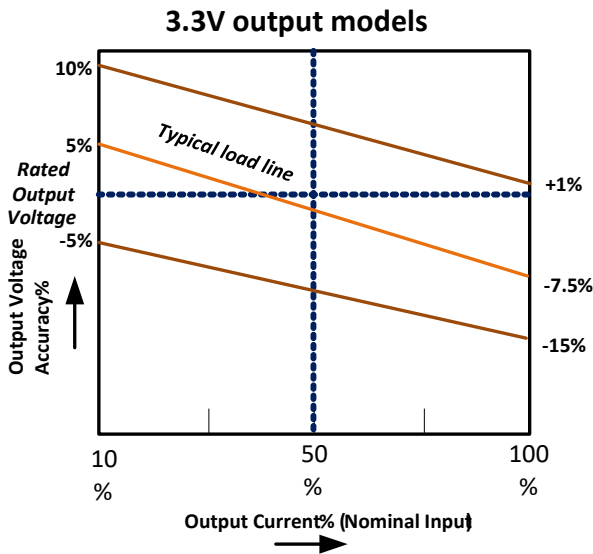

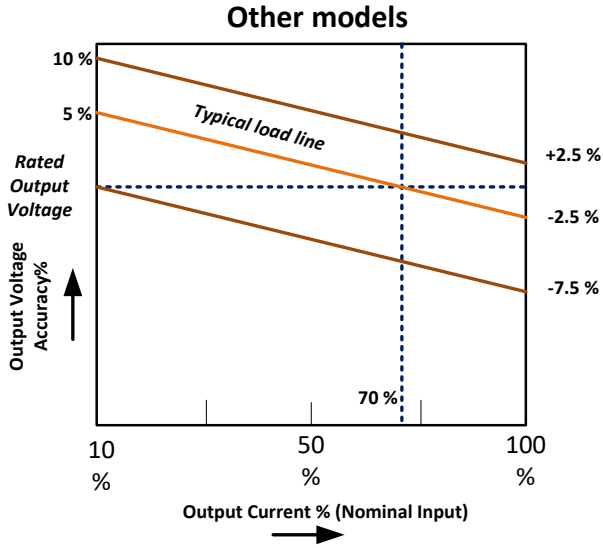

Typical Application Circuit

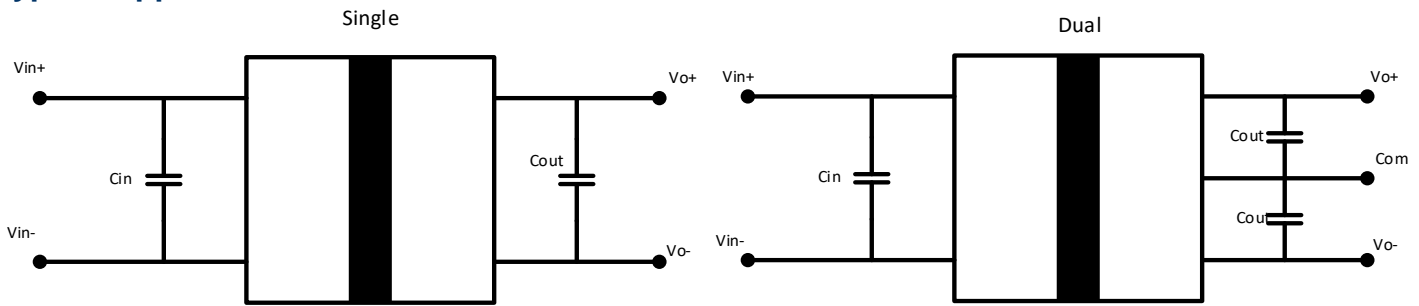

Vin	Cin	Vout (Single)	Cout (Single)	Vout (Dual)	Cout (Dual)
3.3 & 5 V	4.7	3.3 & 5 V (9V for 3KV isolation models)	10 μ F	\pm 3.3 & \pm 5 V	4.7 μ F
12 V	2.2	9 & 12 V	2.2 μ F	\pm 9 & \pm 12 V	1 μ F
15 V	2.2	15 & 24 V	1 μ F	\pm 15 & \pm 24 V	0.47 μ F
24 V	1	-	-	-	-

EMC Recommended Circuit (Class B)

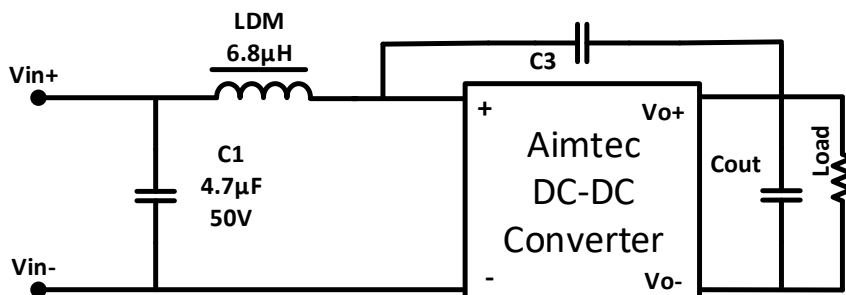

Vin	C3	Cout
3.3, 5, 12V	1nF/2KVDC (1.5KV isolation models)	Refer to typical application circuit
15, 24V		

EMC Recommended Circuit (Class B) for models with suffix JZ

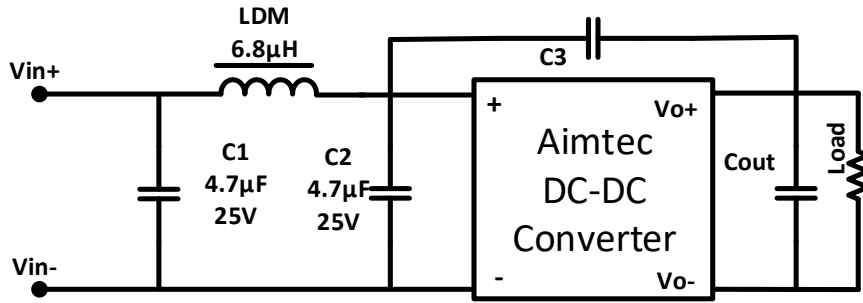

Vout	C3	Cout
3.3, 5, 9V		Refer to typical application circuit
12, 15, 24V	1nF/4KVDC	

Derating

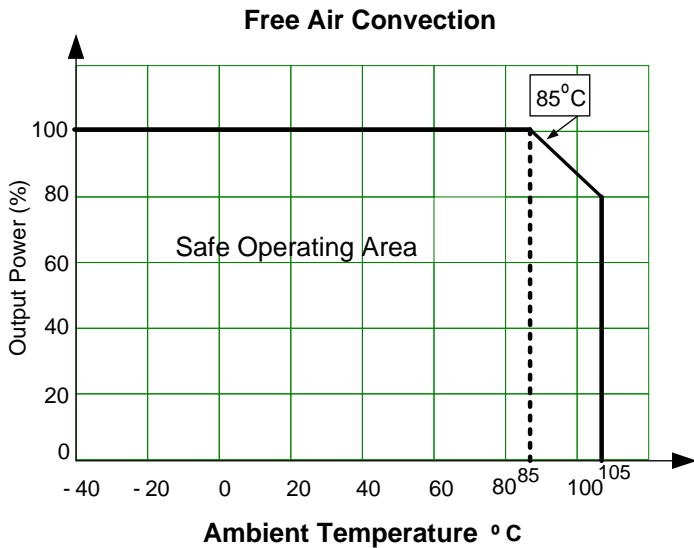

Typical Efficiency Example Charts

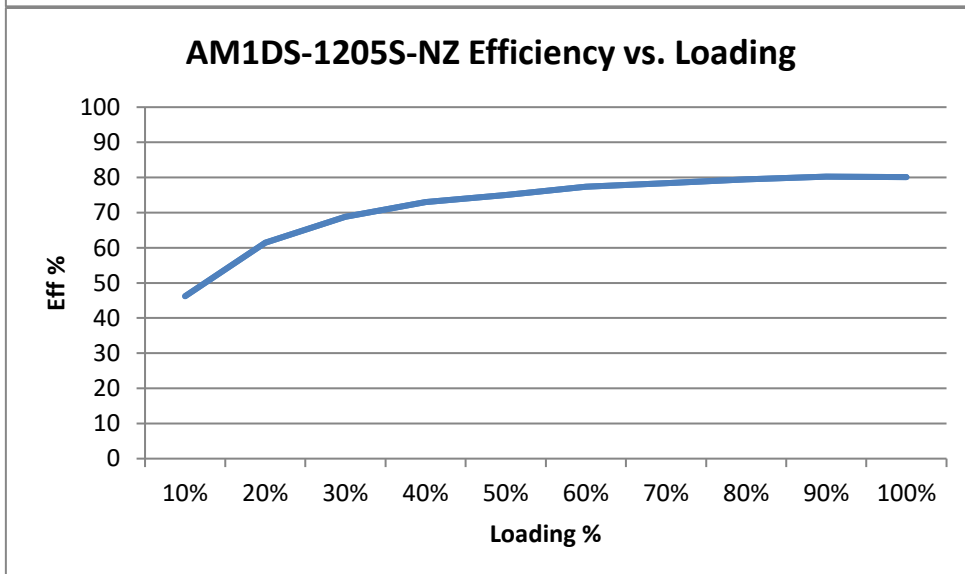
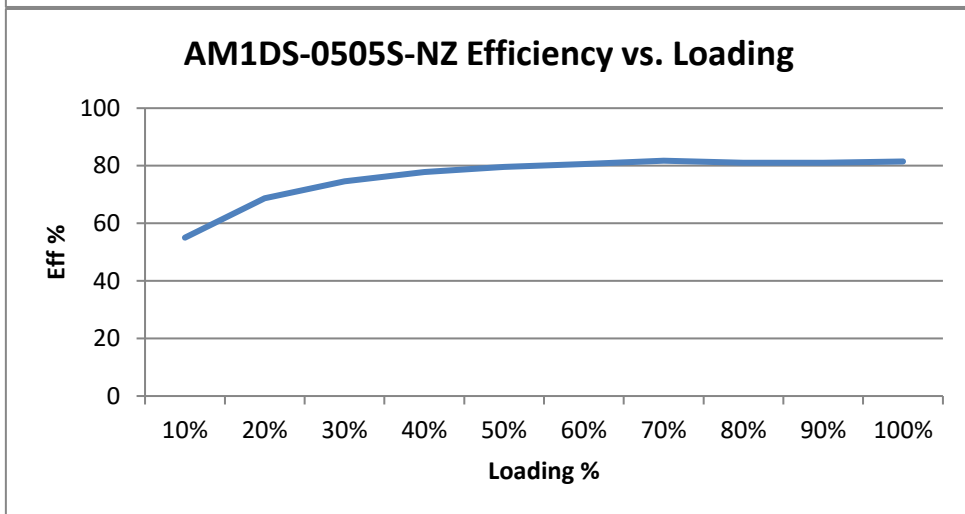
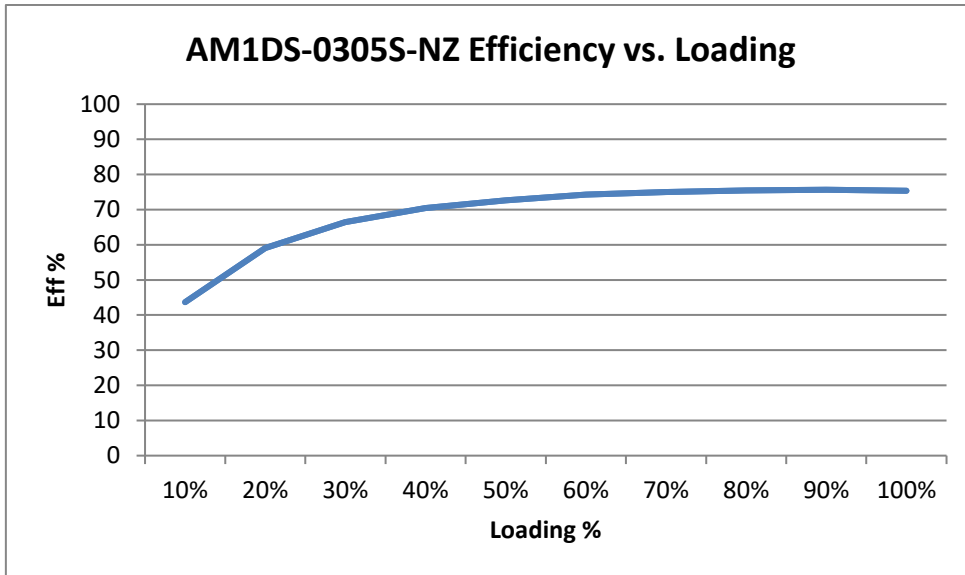

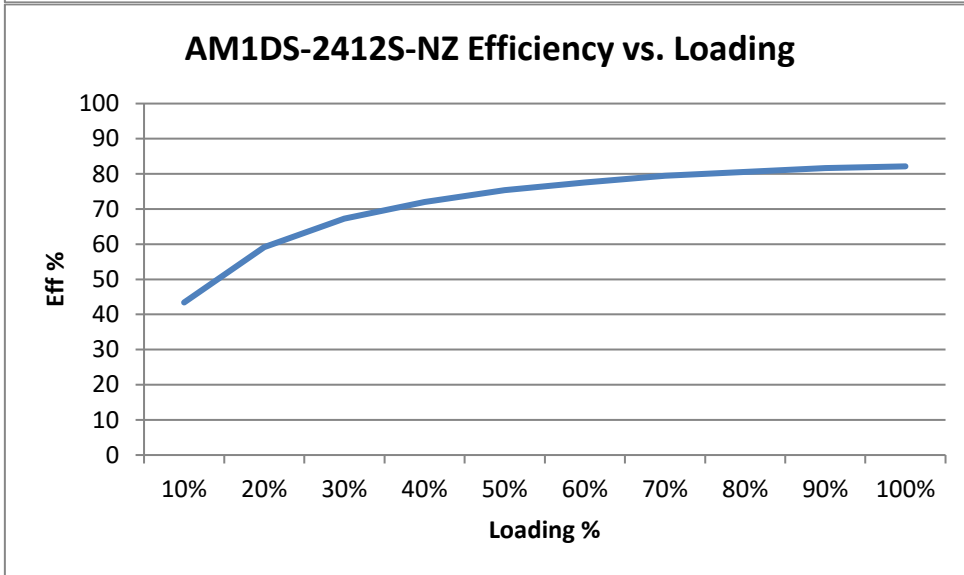
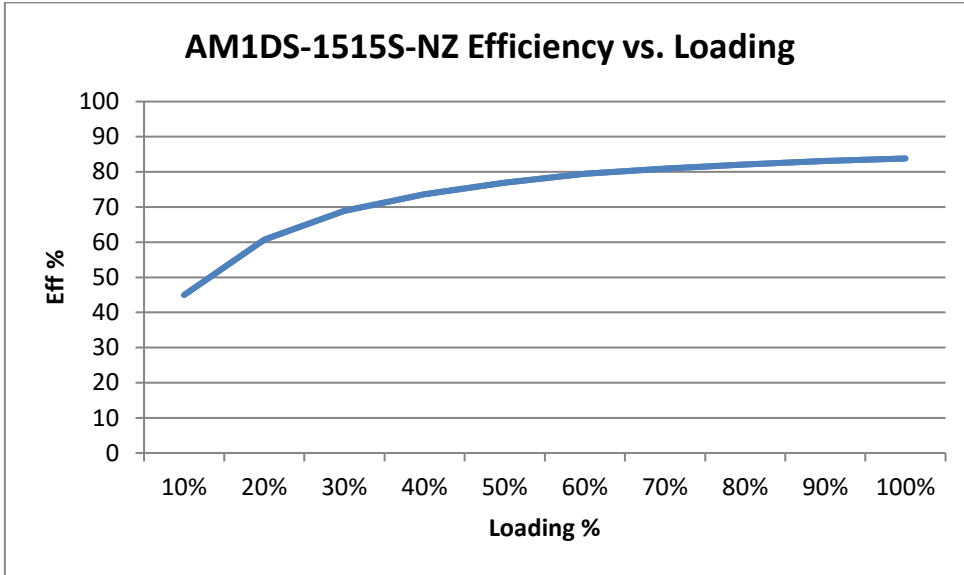

NOTE: **1.** Datasheets are updated as needed and as such, specifications are subject to change without notice. Once printed or downloaded, datasheets are no longer controlled by Aimtec; refer to www.aimtec.com for the most current product specifications. **2.** Product labels shown, including safety agency certifications on labels, may vary based on the date manufactured. **3.** Mechanical drawings and specifications are for reference only. **4.** All specifications are measured at an ambient temperature of 25°C, humidity<75%, nominal input voltage and at rated output load unless otherwise specified. **5.** Aimtec may not have conducted destructive testing or chemical analysis on all internal components and chemicals at the time of publishing this document. CAS numbers and other limited information are considered proprietary and may not be available for release. **6.** This product is not designed for use in critical life support systems, equipment used in hazardous environments, nuclear control systems or other such applications which necessitate specific safety and regulatory standards other the ones listed in this datasheet. **7.** Warranty is in accordance with Aimtec's standard Terms of Sale available at www.aimtec.com.