



Parameter	Rating	Units
Load Voltage	350	V <sub>P</sub>
Load Current	120	mA
Maximum On-Resistance	25	Ω
Input Control Current	2	mA

**Features**

- Integrated Active Current-Limit Protection
- Thermal Shutdown
- Guaranteed Turn-On: 2mA Input Control Current
- 350V<sub>P</sub> Blocking Voltage
- 3750V<sub>rms</sub> Input/Output Isolation
- Small Surface Mount Package
- Low Drive Power Requirements (TTL/CMOS Compatible)
- Arc-Free With No Snubbing Circuits
- No EMI/RFI Generation
- Machine Insertable, Wave Solderable

**Applications**

- Telphony hook switch
- VoIP gateways, such as VoIP
- IP-PBXs
- Satellite and cable set-top boxes
- V.92 (and other standard) modems
- Fax machines
- Voicemail systems
- Embedded modems for POS terminals, automated banking, remote metering, vending machines, security, and surveillance
- Instrumentation
- Medical equipment—Patient/equipment isolation
- Aerospace
- Industrial controls

**Pin Configuration**

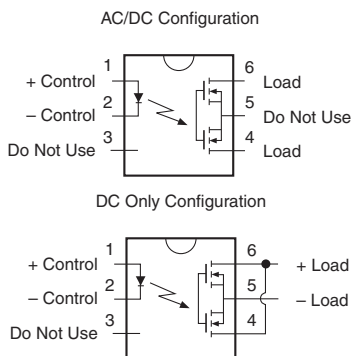

**Description**

The CPC1540 is a normally open (1-Form-A) Solid State Relay with an integrated current limit feature that can replace electromechanical relays while enhancing the robustness of wireline-interface applications.

Designed specifically to target the hook switch telephony market, the CPC1540 has a load voltage rating of 350V.

The relay is constructed using a GaAIAs LED for actuation control and an integrated monolithic die for the switch output. The die, fabricated in a high-voltage dielectrically isolated technology, comprises a photodiode array, switch control with active current limiting circuitry, and MOSFET switches. Active current-limit circuitry in the CPC1540 provides a thermal shutdown feature, offering excellent power-cross immunity for improved survivability in harsh environments.

These enhancements greatly improve the robustness of end systems using this device compared to systems using relays without the integrated current limit. In addition, the active current limit circuitry enables the CPC1540 to pass FCC 68.302 and other regulatory voltage surge requirements when adequate overvoltage protection is provided. The CPC1540 relay may be used in both AC and DC applications.

**Approvals**

- UL Pending
- CSA Certified Component: Certificate 1172007
- EN/IEC 60950-1 Certified Component: TUV Certificate: B 10 05 49410 006

**Ordering Information**

Part #	Description
CPC1540G	6-Pin DIP (50/Tube)
CPC1540GS	6-Pin Surface Mount (50/Tube)
CPC1540GSTR	6-Pin Surface Mount, Tape & Reel (1000/Reel)

**Switching Characteristics of Normally Open Devices**

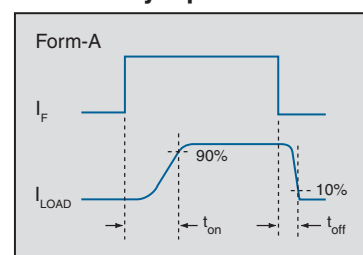

## Absolute Maximum Ratings @ 25°C

Parameter	Ratings	Units
Blocking Voltage	350	$V_P$
Reverse Input Voltage	5	V
Input Control Current	50	mA
Peak (10ms)	1	A
Input Power Dissipation <sup>1</sup>	150	mW
Total Power Dissipation <sup>2</sup>	800	mW
Isolation Voltage, Input to Output (60 Seconds)	3750	$V_{rms}$
Operational Temperature	-40 to +85	°C
Storage Temperature	-40 to +125	°C

Absolute Maximum Ratings are stress ratings. Stresses in excess of these ratings can cause permanent damage to the device. Functional operation of the device at conditions beyond those indicated in the operational sections of this data sheet is not implied.

<sup>1</sup> Derate linearly 3.33 mW / °C

<sup>2</sup> Derate linearly 6.67 mW / °C

## Recommended Operating Conditions

Parameter	Symbol	Configuration	Min	Nominal	Max	Units
Load Current, Continuous	$I_L$	AC/DC	-	-	120	$mA_{rms} / mA_{DC}$
		DC-Only	-	-	250	$mA_{DC}$
Input Control Current	$I_F$	-	3	5	10	mA
Operating Temperature	-	-	-40	-	+85	°C

## Electrical Characteristics @ 25°C

Parameter	Conditions	Symbol	Min	Typ	Max	Units
<b>Output Characteristics</b>						
Current Limit						
AC/DC Configuration	$I_F=5mA, V_L=13V, t=5ms$	$I_{LMT}$	190	225	285	mA
DC Configuration	$I_F=5mA, V_L=6.5V, t=5ms$		360	430	570	
On-Resistance						
AC/DC Configuration	$I_F=5mA, I_L=120mA$	$R_{ON}$	12	18.2	25	$\Omega$
DC Configuration	$I_F=5mA, I_L=220mA$		3	4.2	6.75	
Off-State Leakage Current	$V_L=350V$	$I_{LEAK}$	-	-	1	$\mu A$
Switching Speeds						
Turn-On	$I_F=5mA, I_L=100mA$	$t_{on}$	-	0.72	2	ms
Turn-Off		$t_{off}$	-	0.3		
Output Capacitance	$I_F=0mA, V_L=20V$	$C_O$	-	14	-	pF
<b>Input Characteristics</b>						
Input Control Current to Activate	$I_L=100mA$	$I_F$	-	0.8	2	mA
Input Control Current to Deactivate	$I_L < 1\mu A$	$I_F$	0.2	0.6	-	mA
LED Forward Voltage	$I_F=5mA$	$V_F$	0.9	1.24	1.4	V
Reverse Input Current	$V_{IN} = -5V$	$I_R$	-	-	10	$\mu A$
<b>Common Characteristics</b>						
Input to Output Capacitance	-	$C_{I/O}$	-	0.5	-	pF

**PERFORMANCE DATA\***

**Typical LED Forward Voltage Drop vs. Temperature**

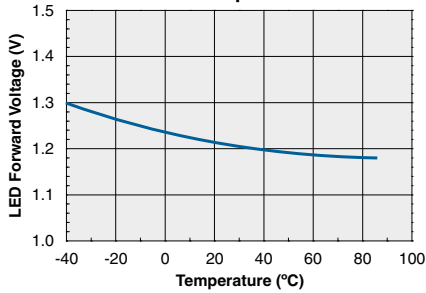

**Typical Turn-On Time vs. LED Forward Current ( $I_L=100\text{mA}$ )**

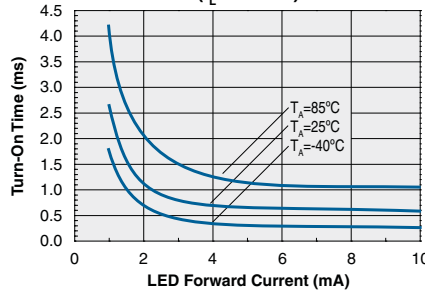

**Typical Turn-Off Time vs. LED Forward Current ( $I_L=100\text{mA}$ )**

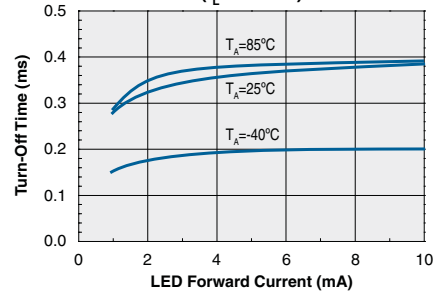

**Typical  $I_F$  for Switch Operation vs. Temperature ( $I_L=100\text{mA}$ )**

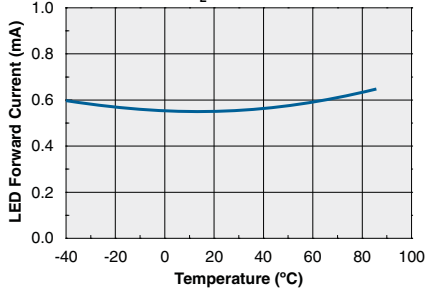

**Typical Turn-On Time vs. Temperature ( $I_F=5\text{mA}$ ,  $I_L=100\text{mA}$ )**

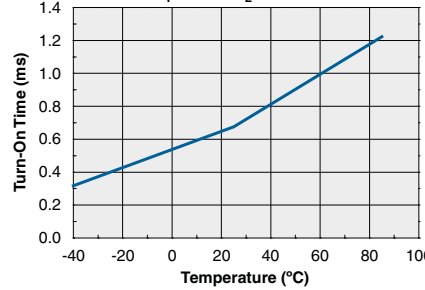

**Typical Turn-Off Time vs. Temperature ( $I_F=5\text{mA}$ ,  $I_L=100\text{mA}$ )**

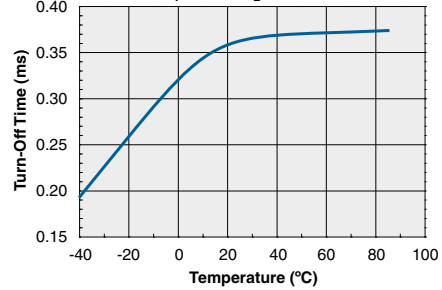

**On-Resistance vs. Temperature ( $I_F=5\text{mA}$ ,  $I_L=100\text{mA}$ )**

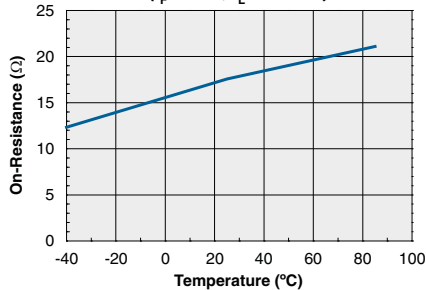

**On-Resistance vs. LED Current ( $I_L=100\text{mA}$ ,  $T_A=25^\circ\text{C}$ )**

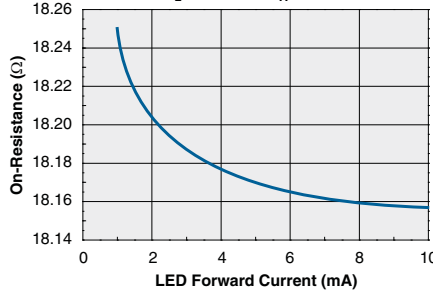

**Typical Leakage Current vs. Temperature ( $I_F=5\text{mA}$ ,  $I_L=100\text{mA}$ ,  $V_L=350\text{V}$ )**

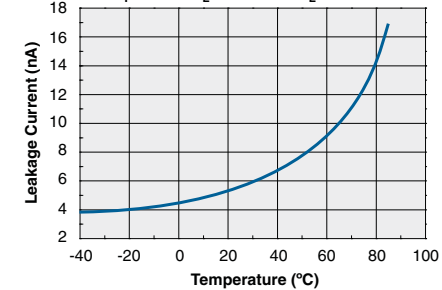

**Output Capacitance vs. Applied Voltage ( $I_F=0\text{mA}$ ,  $f=1\text{MHz}$ )**

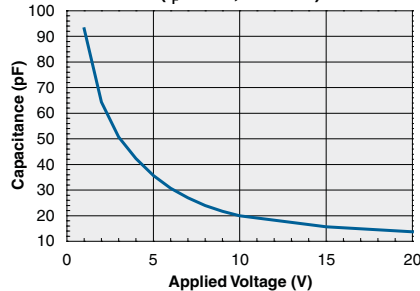

**Current Limit vs. Temperature ( $I_F=5\text{mA}$ )**

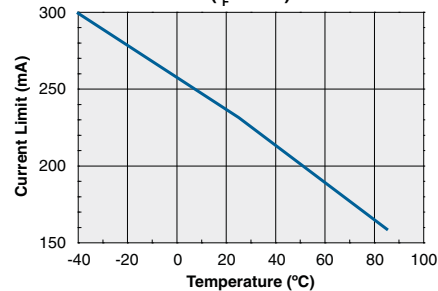

\*The Performance data shown in the graphs above is typical of device performance. For guaranteed parameters not indicated in the written specifications, please contact our application department.

## Manufacturing Information

### Moisture Sensitivity



All plastic encapsulated semiconductor packages are susceptible to moisture ingress. Clare classified all of its plastic encapsulated devices for moisture sensitivity according to the latest version of the joint industry standard, **IPC/JEDEC J-STD-020**, in force at the time of product evaluation. We test all of our products to the maximum conditions set forth in the standard, and guarantee proper operation of our devices when handled according to the limitations and information in that standard as well as to any limitations set forth in the information or standards referenced below.

Failure to adhere to the warnings or limitations as established by the listed specifications could result in reduced product performance, reduction of operable life, and/or reduction of overall reliability.

This product carries a **Moisture Sensitivity Level (MSL) rating** as shown below, and should be handled according to the requirements of the latest version of the joint industry standard **IPC/JEDEC J-STD-033**.

Device	Moisture Sensitivity Level (MSL) Rating
CPC1540G / CPC1540GS	MSL 1

### ESD Sensitivity

This product is **ESD Sensitive**, and should be handled according to the industry standard **JESD-625**.



### Reflow Profile

This product has a maximum body temperature and time rating as shown below. All other guidelines of **J-STD-020** must be observed.

Device	Maximum Temperature x Time
CPC1540G / CPC1540GS	250°C for 30 seconds

### Board Wash

Clare recommends the use of no-clean flux formulations. However, board washing to remove flux residue is acceptable. Since Clare employs the use of silicone coating as an optical waveguide in many of its optically isolated products, the use of a short drying bake could be necessary if a wash is used after solder reflow processes. Chlorine- or Fluorine-based solvents or fluxes should not be used. Cleaning methods that employ ultrasonic energy should not be used.



**MECHANICAL DIMENSIONS**

**CPC1540G**

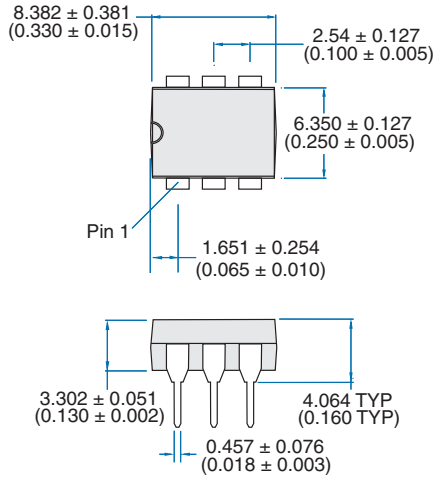

**PCB Hole Pattern**

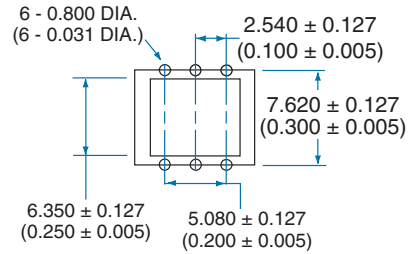

Dimensions  
mm  
(inches)

**CPC1540GS**

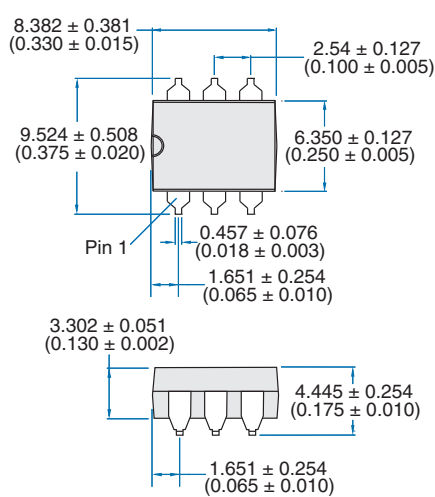

**PCB Land Pattern**

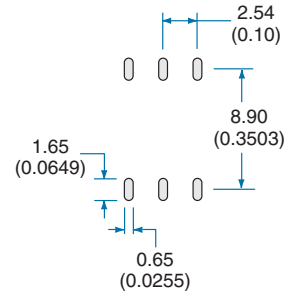

Dimensions  
mm  
(inches)

**MECHANICAL DIMENSIONS**

**CPC1540GS Tape & Reel**

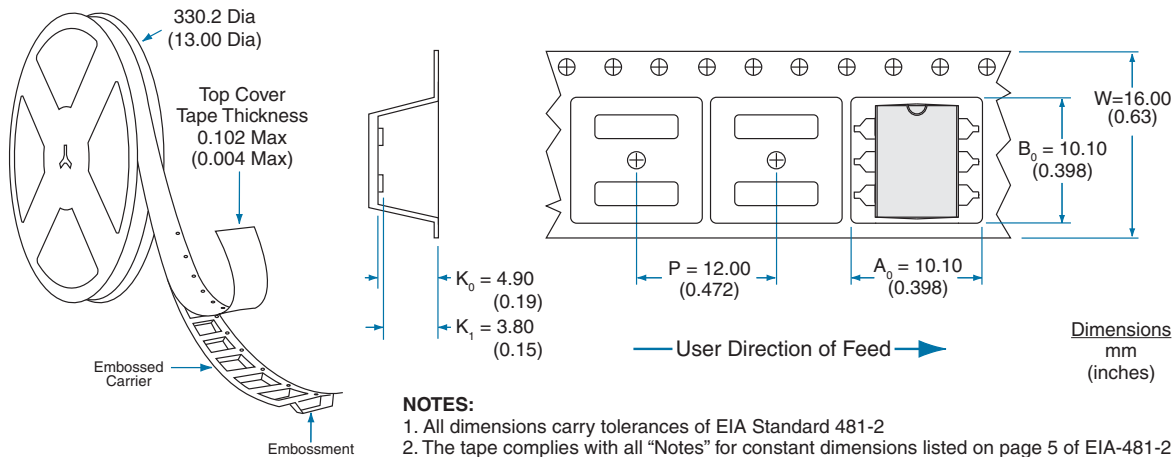

**For additional information please visit our website at: [www.clare.com](http://www.clare.com)**

Clare, Inc. makes no representations or warranties with respect to the accuracy or completeness of the contents of this publication and reserves the right to make changes to specifications and product descriptions at any time without notice. Neither circuit patent licenses nor indemnity are expressed or implied. Except as set forth in Clare's Standard Terms and Conditions of Sale, Clare, Inc. assumes no liability whatsoever, and disclaims any express or implied warranty, relating to its products including, but not limited to, the implied warranty of merchantability, fitness for a particular purpose, or infringement of any intellectual property right.

The products described in this document are not designed, intended, authorized or warranted for use as components in systems intended for surgical implant into the body, or in other applications intended to support or sustain life, or where malfunction of Clare's product may result in direct physical harm, injury, or death to a person or severe property or environmental damage. Clare, Inc. reserves the right to discontinue or make changes to its products at any time without notice.