

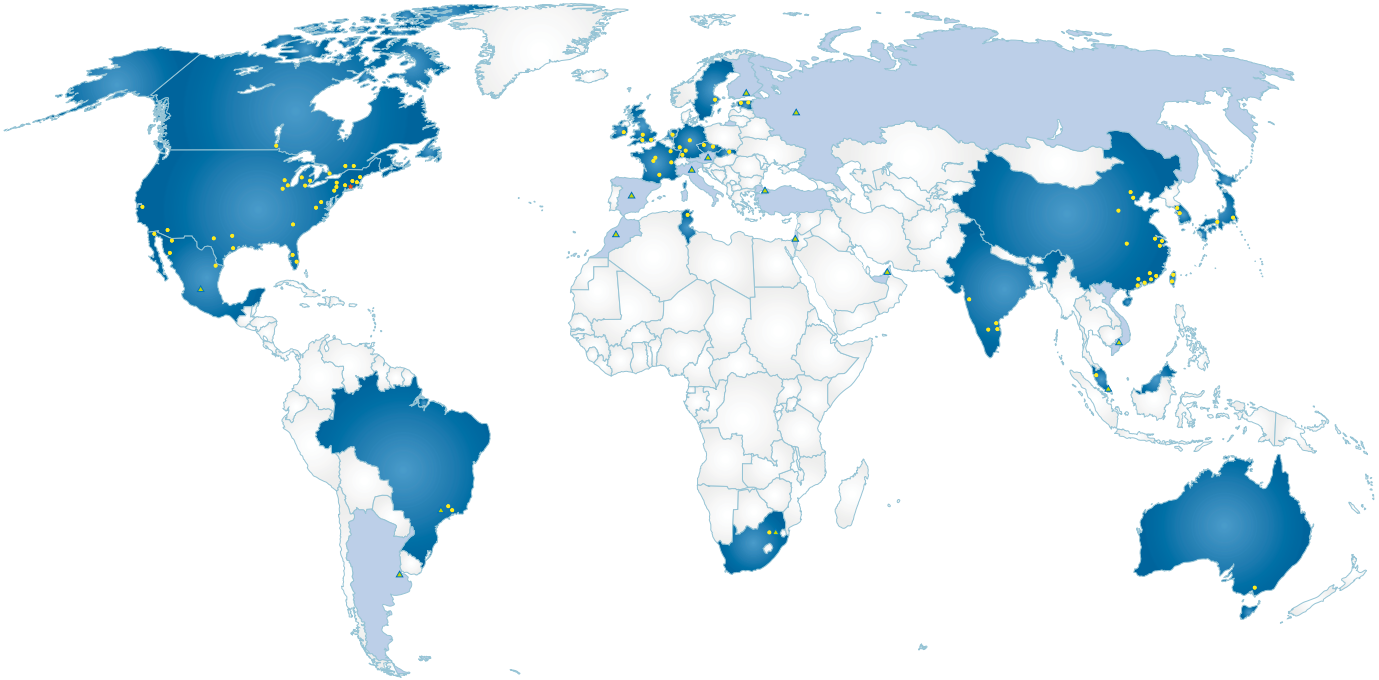

CATALOGUE

Amphenol Group | Global Presence



**Sales, R&D, and
Manufacturing on
6 continents**
79% of workforce in
low-cost countries

- = MANUFACTURING OPERATIONS
- ▲ = SALES OFFICES
- ★ = HEADQUARTERS

AMERICA
CANADA
USA
MEXICO

EUROPE
FRANCE
FINLAND
GERMANY
ITALY
SPAIN
SWEDEN
NORWAY
RUSSIA
SAUDI ARABIA

ASIA
TAIWAN
CHINA
JAPAN
PHILIPPINES
MALAYSIA
SINGAPORE
INDIA

SOUTH AFRICA
AUSTRALIA
NEWZELAND

Amphenol LTW | Global Service



We listen to your needs.

Amphenol LTW Technology Co., Ltd. (Headquarter)

9F., No.657-12, Zhongzheng Rd., Xinzhuang Dist., New Taipei City 242, Taiwan
Telephone: +886-2-29085626 Fax: +886-2-29029787
www.amphenolltw.com

Shulin plant, Taiwan

No.10, Shutan St., Shulin Dist., New Taipei City 238, Taiwan

Kunshan plant, China

No. 62 Da Tung Road, Peng Lang Street, Kunshan City , Jiangsu Province, China
Telephone: +86-512-5761-0501
Fax: : +86-512-5761-0515

For further information, please contact :

Sales & Marketing Department | Email : sales@ltw-tech.com

Our Mission

Amphenol LTW is fully committed to contributing to a safer and greener environment toward an open and friendlier world. ALTW actively and proactively become the interconnects of choice for technologically advanced products with purposes such as:

- Generating power and energies from renewable sources
- Protecting, conserving, saving and better managing resources
- Warning and preventing natural disasters such earthquakes, tsunamis, landslides, flooding...
- Lighting up buildings, residences, streets and factories at lowest possible costs in the most efficiently and environmental friendly ways
- Detecting, monitoring and managing goods and people for seamless flow and exchanges around the world
- Enabling higher speed and broadband communications and telecommunications
- Producing higher yield of crops and maximizing the use of scarce "agricultural" lands
- Accelerating the proliferation of organic crops
- Delivering safe and quality food
- Preventing shortage of food and enabling the production of sufficient food
- Enabling higher productivities in farms while enhancing qualities of produces
- Allowing higher productivities and efficiencies in factories and industries
- Facilitating automation and reducing labor costs and risks
- Making biotechnologies a reality and common place in tomorrow's world
- Ensuring life-saving products available whenever and wherever they are much needed
- Facilitating the "rugged revolution" in mobile world

Amphenol LTW is the innovator and solution provider for products to be used harsh and rugged environments.

Create Company's Profile and New Industry Orientation by Innovation & Differentiation

Research Innovation
R&D Management
Technology Foundation

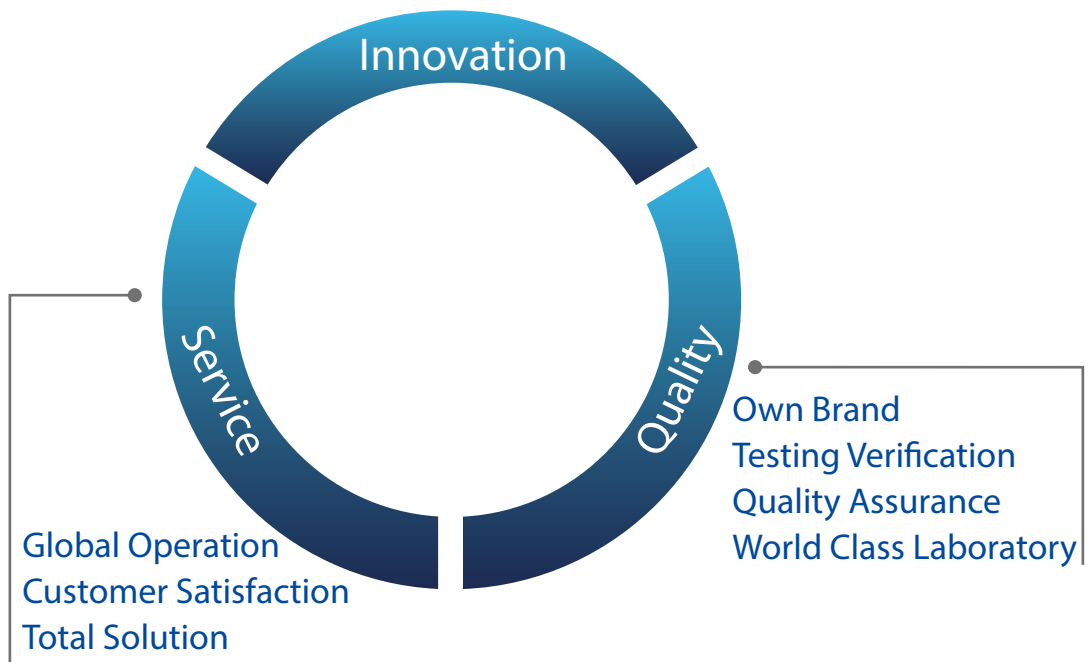

Our History

LTW Technology Co., Ltd, established in March 1993, is the innovator and solution provider for all products that are to be used in harsh and rugged environments indoor or outdoor.

In April 2010, Amphenol Corp (NYSE: APH) acquired LTW Technology ("ALTW") which become Amphenol LTW Technology Co., Ltd.

Amphenol LTW Technology is the leader in rugged and harsh environment interconnects with largest array of I/O and products ranging from IP65 to IP69K. ALTW continuously provides innovative products and solutions for an ever demanding environment with patents covering China, Taiwan, Japan, South Korea, Europe and North America, etc...

Together with our customers, ALTW participate and contribute to a better world, greener and safer environment.

Amphenol LTW



1993
Established

2000
Opened Kun Shan
Zhrengri
(KSZ)Electronics
in Kunshan, China

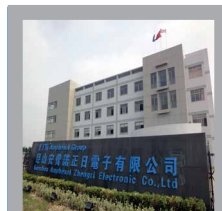

2002
LTW moved to
Shinjuang
City, Taipei.

2004
KSZ expanded plant
to 17,000 sqm.



2006
Established 2nd
Factory in Taipei
with CNC
Automatic Lathe &
Automation Center



















2008
Taiwan Small &
Medium Enterprise
Innovation Award

Innovation Research
Award

2010
LTW was acquired by
Amphenol Group in
April of 2010

Shortcut by Product Series

Circular Connector	Power Connector	M Series Sensor Connector	USB Connector
			
<ul style="list-style-type: none"> • Screw Threaded Type, Lock Bayonet Type or Push Lock Type • Receptacle, Receptacle with cable, Overmolded With Cable & Field Installable available • Options from 2 to 31 contacts, 2A to 20A • Various sizes, over 1000 items, plastic and metal • UV Resistant • IP65/66/67/68 waterproof mated or unmated • Operating temperature <ul style="list-style-type: none"> ◦ Field installable: -20°C ~ 105°C ◦ Receptacle: -40°C ~ 105°C ◦ Receptacle with cable: -20°C ~ 80°C ◦ Overmolded with Cable: -20°C ~ 80°C • Customizations are possible • Hybrid available <div style="text-align: right;">  <p>P 1-1</p> </div>	<ul style="list-style-type: none"> • Screw Threaded or Lock Bayonet Type (2 points & 3 points) • Receptacle, Overmolded With Cable & Field Installable available • Options from 2 to 7 contacts, 8A to 30A • Over 110 plastic items • UV Resistant • Operating temperature <ul style="list-style-type: none"> ◦ Overmolded with Cable: -20°C ~ 80°C ◦ Receptacle: -40°C ~ 105°C ◦ Field installable: -40°C ~ 105°C • IP67/68 waterproof mated or unmated • Customizations are possible • Hybrid available • Safety locking available (25A & 30A) • Touch Safe (IP2X) available (25A & 30A) <div style="text-align: right;">  <p>P 2-1</p> </div>	<ul style="list-style-type: none"> • Available in M8 (3P~5P & 8P); M12 (3P ~ 12 in A, B, D & X Codes); Mini 7/8" 5P • Compact and rugged design available in IP67/IP68 waterproof • Available in Stamped, Screw-In, PCB and Solder Contacts • Receptacle (M12 90° PCB), Field Installables & Molded With Cable available • Meets industry standards (IEC, NMEA2000, DeviceNet, EtherNet I/P, Profibus & ProfiNet) • Operating temperature <ul style="list-style-type: none"> ◦ Field installable: -40°C ~ 105°C ◦ Receptacle: -40°C ~ 105°C ◦ Overmolded with Cable <ul style="list-style-type: none"> PVC Cable: -20°C~80°C PU Cable: -20°C~85°C • Hexagonal-Shaped Diecasted Screw Nuts for Cable Assy for easier Tool access • PVC, PUR Jackets available for cables (Sun, Oil Resistant & Flame rated) • UL/CSA Approval • Hybrid Available Upon Request <div style="text-align: right;">  <p>P 3-1</p> </div>	<ul style="list-style-type: none"> • Screw Threaded or Lock Bayonet Type • USB A, USB B and Mini USB • IP67/IP68 mated and unmated waterproof • Receptacle, Overmolded With Cable available • UV Resistant • Operating temperature <ul style="list-style-type: none"> ◦ Field installable: -20°C ~ 80°C ◦ Overmolded with Cable: -20°C ~ 80°C ◦ Receptacle <ul style="list-style-type: none"> Nylon+GF: -40°C ~ 105°C M-PPE: -40°C ~ 105°C ABS: -20°C ~ 80°C ◦ Receptacle with cable <ul style="list-style-type: none"> Nylon+GF: -20°C ~ 105°C ABS: -20°C ~ 80°C • Easy & simple connection structure • PnP – plug and play • Master/Slave framework <div style="text-align: right;">  <p>P 4-1</p> </div>
<ul style="list-style-type: none"> * Mini (A) - Size * Standard (B) - Size * Middle (C) - Size * Large (D) - Size * Macro (E) - Size * Others - Size 	<ul style="list-style-type: none"> * 8A * 12A * 16A * 20A * 25A * 30A * 20A+2A 	<ul style="list-style-type: none"> * M8 * M10.5 * M12 * M20 * M23 	<ul style="list-style-type: none"> * USB 3.0 A Type * USB 2.0 A Type * USB 2.0 B Type * Mini USB 2.0 B Type

IEEE 1394 Connector	D-SUB Connector	DVI Connector	RJ Connector
			
<ul style="list-style-type: none"> • Receptacle, Overmolded With Cable & Field Installable available • Screw Threaded Type • 0.5A • UV Resistant • Operating temperature <ul style="list-style-type: none"> ⊙ Field installable: -20°C ~ 80°C ⊙ Receptacle: -20°C ~ 80°C ⊙ Overmolded with Cable: -20°C~80°C • IP67/68 Unmated <div style="text-align: right; margin-top: 20px;">  <p>P 5-1</p> </div>	<ul style="list-style-type: none"> • Standard D-Sub (9/15/25/37 /50 contacts), High Density D-Sub (15/26/44/62/78 contacts) and Mixed Options Available • Receptacle, Overmolded With Cable & Field Installable available • Various Connection types, such as hand solder, wire wrap, straight and angled PCB, with and without boardlock, and flat cables • High Reliability for Harsh Environment • IP67/IP68 waterproof • Special Latches instead of thumb screws available • Operating temperature <ul style="list-style-type: none"> ⊙ Field installable: -20°C ~ 105°C ⊙ Overmolded with Cable: -20°C ~ 80°C ⊙ Receptacle: -20°C~105°C <div style="text-align: right; margin-top: 20px;">  <p>P 6-1</p> </div>	<ul style="list-style-type: none"> • DVI-D Single Link (DDS), DVI-I Single Link (DIS), DVI-D Dual Link (DDD) and DVI-I Dual Link (DID) available • Receptacle and Overmolded With Cable available • Screw Threaded Type • 0.5A • 19/23/25/29 contacts available • UV Resistant • Operating temperature <ul style="list-style-type: none"> ⊙ Overmolded with Cable: -20°C ~ 80°C ⊙ Receptacle: -20°C~105°C • IP67/68 waterproof <div style="text-align: right; margin-top: 20px;">  <p>P 7-1</p> </div>	<ul style="list-style-type: none"> • Screw Threaded or lock Bayonet Type • Receptacle, Overmolded With Cable & Field Installable available • Shielded & Unshielded versions • Fast connectivity Networking in Harsh environments • IDC, RJ Jack in 180 & 90 deg., Terminal Block and Cable terminated • Meets industry standards (ODVA, ProfiNet) • UV Resistant • Operating temperature <ul style="list-style-type: none"> ⊙ Overmolded with Cable: -20°C ~ 80°C ⊙ Receptacle: -40°C~105°C • IP67/IP68 mated and unmated <div style="text-align: right; margin-top: 20px;">  <p>P 8-1</p> </div>

* IEEE 1394B

* Standard
* High Density

* DVI-Single Link
* DVI-Dual Link
* DVI-D Single Link
* DVI-D Dual Link

* Cat. 5e









SSL Solution Connector	LED Indicator	HDMI Connector	Sata Connector
			
<ul style="list-style-type: none"> • For B-to-B, W-to-B, W-to-W • Available in 1P, 2P, 4P and 6P • Standard or IP67 • SMT Board Connector for PCB: FR4, MC, or Ceramic • With and without Mounting boardlock • With or Without Lock or Latch • Board Connectors in Right Angle, Straight, or Inverted • Horizontal or Vertical Connection or Disconnection • Overmolded Cable Straight or Right Angle • Operating temperature <ul style="list-style-type: none"> ⊙ Receptacle: -40°C ~ 100°C • Natural white color for all connector housings and over-molding • UL recognized (UL approved upon request) • Lead Free and RoHS Compliant 	<ul style="list-style-type: none"> • LED lights for your device (Receptacle only) • Light color: red, blue, green, white, yellow and red/green • Plastic LED (Ø3mm) or metal LED (Ø3mm and Ø5mm) • Operating temperature <ul style="list-style-type: none"> ⊙ Metal: -20°C ~ 105°C ⊙ Plastic: -20°C ~ 85°C • IP67 Unmated 	<ul style="list-style-type: none"> • Receptacle (Jack) and Overmolded With Cable (Plug) available • Latch type for 90° PCB • 0.2A • Maximum cable length 5M • UV Resistant • Operating temperature <ul style="list-style-type: none"> ⊙ Receptacle: -20°C ~ 80°C ⊙ Overmolded with Cable: -20°C ~ 80°C • IP67 Unmated 	<ul style="list-style-type: none"> • Snap in with latch: insertion and extraction are easy and quick • Overmolded With Cable and PCB type (Socket) for SMD or DIP • Harpoon board lock or flat board lock • 1.6, 2.6, 3.2mm mounting board-lock available • SATA 2.6 • Available contacts : 7P • Current Capacity : 1.5A • Over-molded Wires Size : #26 • 15V DC • Black color for all connector housings and over-molding • UL recognized materials • Lead Free and RoHS Compliant • PCB thickness 1.6 mm • IEC 60529 / IP67 mated • Sata III available (upon request) • Operating temperature <ul style="list-style-type: none"> ⊙ Receptacle: -20°C ~ 80°C ⊙ Overmolded with Cable: -20°C ~ 80°C
 <p style="text-align: right;">P 9-1</p>	 <p style="text-align: right;">P 10-1</p>	 <p style="text-align: right;">P 11-1</p>	 <p style="text-align: right;">P 12-1</p>

* SSL-1

* M8

* Plug
* Jack

* PCB Type
* Overmolded Plug

Fiber Optic Connector	NMEA 2000 Connector	PV AC Connectors / T-Junction	
		<p>VTC</p> 	<p>SMC</p>  <hr/> <p>BMC</p> 
<ul style="list-style-type: none"> • Receptacle (Jack) & Field Installable (Plug) available • For SC & LC types • Lock Bayonet Type (2 points & 3 points) • UV Resistant • Operating temperature <ul style="list-style-type: none"> ◉ Field installable: -40°C ~ 105°C ◉ Receptacle: -40°C ~ 105°C • IP67 mated <div style="text-align: right;">  <p>P 13-1</p> </div>	<ul style="list-style-type: none"> • Available in Micro Style "M12" 5P Conn & Mini Style " 7/8" 5P Conn for drop and trunk lines respectively • Compatible with Industrial Bus Systems (Devicenet & Profibus) • Compact and rugged design available in IP67/IP68 unmated waterproof to withstand harsh marine environments • Available in Stamped, screw-in, PCB and solder contacts • Panel mounts (M12 90° PCB), Field Installable, Tee Adapters, Molded With Cable & Junction Boxes available • Operating temperature <ul style="list-style-type: none"> ◉ Receptacle: -40°C ~ 85°C ◉ Overmolded with Cable: -20°C ~ 80°C ◉ Field installable <ul style="list-style-type: none"> Nylon+GF: -40°C~105°C PU: -20°C~85°C • Corrosion & Vibration Resistant • Thin & Thick PVC Cables available (Sun, Oil Resistant & Flame rated) • Various cable lengths to match installation requirements • NMEA 2000® approved <div style="text-align: right;">  <p>P 14-1</p> </div>	<p>VTC (T-Junction / SMC)</p> <ul style="list-style-type: none"> • 3 or 4 Contacts • 300 V/AC, 5A Drop, 30A Trunk • IP 67 waterproof • UV Resistant • Operating temperature : <ul style="list-style-type: none"> Ambient: -40°C ~ +85°C Upon Limited Temperature:+105°C • Intertek approved to UL6703A & UL9703 • Uninterrupted cable - Lower power drop then conventional cabling systems • Various configurations of pitch and T Connector Quantity • Cable End-Cap and Cable Joiner available • Ease of installation and service <div style="text-align: right;">  <p>P 15-1</p> </div>	<p>BMC</p> <ul style="list-style-type: none"> • 3 & 4 Contacts • 300V AC, 17A • Cable TC-ER, UV resistant • Operating temperature : <ul style="list-style-type: none"> -40°C ~ 105°C • Safety Locking • ETL approved according to UL 6703A • Overmolded with cable, plug-nplay • IP 67 waterproof • Touch Safe (IP2X)
<p>* LC Type * SC Type</p>	<p>* Mini * Micro</p>	<p>* T-Junction (VTC) * SMC * BMC</p>	<p>* T-Junction (VTC) * SMC * BMC</p>

* Design and specification are subject to change without notice.

Cable Joiner	Cable Gland - Anti-UV	Vent Connector	RBL Connector
			
<ul style="list-style-type: none"> • Simple and reliable cable interconnections • For various cable OD and wire sizes • Cable OD range 6mm~16mm • Wire range 10AWG~22AWG • Standard crimping butt terminals or screw terminal blocks • UV Resistant • Operating temperature <ul style="list-style-type: none"> ⊙ Field installable PPE: -40°C~105°C Nylon: -40°C~105°C • IP67 waterproof • Safety locking available <div style="text-align: right;">  <p>P 16-1</p> </div>	<ul style="list-style-type: none"> • Various options available, from 1"-20UNEF, M8, M12, M16, M20, M25, M32, M40, PG7, PG9, PG11, PG13.5, PG16 to PG29 • Easily find suitable items for different cable OD • Fit into panel thickness from max 3.0 mm to max 9.0 mm • Product length (with strain relief) from 60.0mm to 96.0mm • Product length (without strain relief) from 22.0 mm to 60.0mm • UV Resistant • Operating temperature <ul style="list-style-type: none"> ⊙ Receptacle: -20°C~105°C • IP67 waterproof <div style="text-align: right;">  <p>P 17-1</p> </div>	<ul style="list-style-type: none"> • M12 . M8 available upon request • Air permeability: 12 sec/100 cm3 or 10 sec/100 cm3 • Water entry pressure: 100kPa • Panel thickness max 6.5 mm • UV Resistant • Operating temperature <ul style="list-style-type: none"> ⊙ Receptacle: -20°C~105°C • IP67 unmated <div style="text-align: right;">  <p>P 18-1</p> </div>	<ul style="list-style-type: none"> • Snap-in with Latch Type • Receptacle, Overmolded With Cable & Field Installable available • 6 contacts • 5A • UV Resistant • IP67 waterproof mated or unmated • Operating temperature <ul style="list-style-type: none"> ⊙ Overmolded with Cable: -20°C~80°C ⊙ Field installable: -40°C~105°C ⊙ Receptacle: -40°C~105°C • Customizations are possible <div style="text-align: right;">  <p>P 19-1</p> </div>
<p>* 6~10 mm</p>	<p>* 1"-20 * M40</p>	<p>* M12 Vent Connector</p>	<p>* Middle Size</p>
<p>* 8~10mm</p>	<p>* M8 * PG7</p>		
<p>* 10~12mm</p>	<p>* M12 * PG9</p>		
<p>* 12~16mm</p>	<p>* M16 * PG11</p>		
	<p>* M20 * PG13</p>		
	<p>* M25 * PG16</p>		
	<p>* M32 * PG29</p>		

X-Lok Connector

- Push Lock Type
- Receptacle, Overmolded With Cable & Field Installable available
- 3 contacts
- 20A
- UV Resistant
- IP67 waterproof mated or unmated
- Operating temperature
 - ⊙ Overmolded with Cable: -20°C~80°C
 - ⊙ Field installable: -40°C~105°C
 - ⊙ Receptacle: -40°C~105°C
- Customizations are possible



P 20-1

* Middle Size

Shortcut by Markets

Renewable Energy			
> <u>Photovoltaic solar (PV) : Micro Inverter, Inverter, Solar tracker</u>			
Circular Connector	P. 1-1	RJ Connector	P. 8-1
Power Connector 25A(PWH) & 30A (PWJ)	P. 2-1	PV AC Connectors / T-Junction Connector	P. 15-1
M Series Sensor Connector	P. 3-1	Cable Joiner	P. 16-1
USB Connector	P. 4-1		

* More to know: Safely Locking & Touch Safe available

> <u>Concentrated solar power (CSP) : Heliostat parabolic trough</u>			
Circular Connector	P. 1-1	RJ Connector	P. 8-1
M Series Sensor Connector	P. 3-1	RBL Connector	P.19-1
X-Lok Connector	P.20-1		

* More available: Y-Connector, T-Connectors, Distribution Boxes, T & Y-Splitters

> <u>Wind : Turbine</u>			
Power Connector 8A(PWF) & 25A (PWH)	P. 2-1	D- SUB Connector	P. 6-1
M Series Sensor Connector	P. 3-1	RJ Connector	P. 8-1

* More available: Y-Connectors, Distribution Boxes, T&Y Splitters

Industrial Automation			
> <u>Industrial robots, Industrial lifts, Communication panels, Packaging, Conveyors, Sensors, Switches</u>			
M Series Sensor Connector	P. 3-1	D- SUB Connector	P. 6-1
USB Connector	P. 4-1	RJ Connector	P. 8-1

* More available: M12-RJ45 Ethernet Adaptor, Passive Distribution boxes, T & Y splitters

LED			
> <u>Outdoor Displays and Billboards, Outdoor Signs & Signage, Architectural Lighting, AV and Entertainment Systems Tunnel Lighting, General Lighting, Aircraft Cabin Lighting, Automotive Lighting, Train Wagon Lighting, Ships and Cargo Lighting, Bus Interior Lighting</u>			
Circular Connector	P. 1-1	RJ Connector	P. 8-1
Power Connector 20A(PWC), 25A(PWH) & 30A (PWJ/PWL)	P. 2-1	PV AC Connectors / T-Junction Connector	P.15-1
M Series Sensor Connector	P. 3-1	SSL Connector	P. 9-1
RBL Connector	P.19-1	X-Lok Connector	P. 20-1

* More available: Hybrid Connecto

Marine			
> <u>Radar, Communications, Audio entertainment, Navigation system & GPS, Fish finders, Instruments / Gauges, Autopilot</u>			
Circular Connector	P. 1-1	NMEA 2000 Connector	P. 14-1
USB Connector	P. 4-1	PV AC Connectors / T-Junction Connector	P. 15-1
D- SUB Connector	P. 6-1	Cable Joiner	P. 16-1
RJ Connector	P. 8-1		

* More available: Adapter, Pre-Cabling Systems & Solutions

Broadband Wireless Access			
> <u>Outdoor Access Points, Outdoor Bridges, Outdoor Backhaul , Outdoor Repeater, Outdoor Base Stations, Satellite Receiver and Transmitter, Antennas</u>			
Circular Connector	P. 1-1	RJ Connector	P. 8-1
M Series Sensor Connector	P. 3-1	Cable Joiner	P. 16-1
USB Connector	P. 4-1	Vent Connector	P. 18-1
D- SUB Connector	P. 6-1		

Smart Grids / Advanced Metering Infrastructure (AMI)			
> <u>Smart meters : Water meter, Electricity meter, Gas meter</u>			
Circular Connector	P. 1-1	PV AC Connectors / T-Junction Connector	P. 15-1
Power Connector	P. 2-1	Cable Joiner	P. 16-1
USB Connector	P. 4-1	Vent Connector	P. 18-1
RJ Connector	P. 8-1		
Construction Machineries / Heavy Vehicles			
> <u>Bus, Trucks, RV, Utilities vehicles, Excavator, Backhoe loader, Crane, Forklift, Bulldozer, Tractors</u>			
Circular Connector	P. 1-1	D- SUB Connector	P. 6-1
Power Connector	P. 2-1	RJ Connector	P. 8-1
M Series Sensor Connector	P. 3-1	Cable Joiner	P. 16-1
USB Connector	P. 4-1	Vent Connector	P. 18-1
RBL Connector	P.19-1	X-Lok Connector	P. 20-1
* More available: T&Y Connector, T&Y Splitters, Hybrid Connector, Distribution box			
IP Closed-circuit Television (IP CCTV)			
> <u>Speed Dome Cameras, Outdoor Dome Cameras, Remote Video Remote Control Device, IP Traffic Control , Homeland Security Prevention and Protection Equipment, IR Sensor, Chemical & Radioactive, Detection Device, Container Security Devices</u>			
Circular Connector Mini (A) & Standard (B)	P. 1-1	RJ Connector	P. 8-1
Power Connector 8A(PWF) & 25A (PWH)	P. 2-1	Cable Joiner	P. 16-1
M Series Sensor Connector	P. 3-1	Vent Connector	P. 18-1
D- SUB Connector	P. 6-1		
Medical Devices			
> <u>Electrical beds, Wheelchair controller</u>			
Circular Connector	P. 1-1	Micro-USB	Available soon
Breakaway Connector	Upon request		
RBL Connector	P.19-1	X-Lok Connector	P. 20-1
Hybrid Electric Vehicle (HEV) / Electric Vehicle (EV)			
> <u>Scooters, Bikes, Golf Carts, Utilities Vehicles</u>			
Circular Connector	P. 1-1	USB Connector	P. 4-1
Power Connector	P. 2-1	D- SUB Connector	P. 6-1
M Series Sensor Connector	P. 3-1	RJ Connector	P. 8-1
RBL Connector	P.19-1	X-Lok Connector	P. 20-1
* More available: BMC Series			
MRT / Railway			
> <u>Traffic System, Sign and Lighting System, Sensor</u>			
Power Connector 8A(PWF) & 12A (PWE)	P. 2-1	RJ Connector	P. 8-1
M Series Sensor Connector	P. 3-1	PV AC Connectors / T-Junction Connector	P. 15-1
USB Connector	P. 4-1	Cable Joiner	P. 16-1
D- SUB Connector	P. 6-1		
RBL Connector	P.19-1	X-Lok Connector	P. 20-1
* More available: BMC Series			
Testing and Measurement Equipment			
Circular Connector	P. 1-1	USB Connector	P. 4-1
M Series Sensor Connector	P. 3-1	RJ Connector	P. 8-1
X-Lok Connector	P. 20-1		

* Design and specification are subject to change without notice.

Safety Detection and Warning System			
> Tsunami Warning Devices, Landslide Detection and Warning			
Circular Connector	P. 1-1	RJ Connector	P. 8-1
M Series Sensor Connector	P. 3-1	Cable Joiner	P. 16-1
USB Connector	P. 4-1	Vent Connector	P. 18-1
RBL Connector	P.19-1	X-Lok Connector	P. 20-1

* More available: T&Y Connectors, T&Y Splitters, Distribution Box

Agricultural and Farming Electronic System			
> Electric Fence System, Electronic Tags and Tracking, Device, Agriculture Weighting Scale, Measuring Devices, Diary Farming Devices			
Circular Connector	P. 1-1	RJ Connector	P. 8-1
M Series Sensor Connector	P. 3-1	PV AC Connectors / T-Junction Connector	P. 15-1
USB Connector	P. 4-1	Cable Joiner	P. 16-1
D-Sub Connector	P. 6-1	RBL Connector	P.19-1
X-Lok Connector	P.20-1		

* More available: T&Y Connectors, T&Y Splitters, Distribution Box

Commercial Military Devices			
> Rugged Notebook, Night Vision Google, Miniature Rugged Camera, Rugged Tablet, Rugged Communication Devices			
Circular Connector	P. 1-1	USB, Mini and Micro-USB Connector	P. 4-1
Power Connector 8A(PWF) & 25A (PWH)	P. 2-1	D- SUB Connector	P. 6-1
M Series Sensor Connector	P. 3-1	RJ Connector	P. 8-1
X-Lok Connector	P. 20-1		

* More available: Breakway connector

Spa Controller			
Circular Connector	P. 1-1	LED Connector	P. 10-1
M Series Sensor Connector M8 & M12	P. 3-1	PPC Connector	Upon request

Metal Detectors			
> Portable Metal Detectors, Airport & Port Security Detection Devices			
Circular Connector	P. 1-1	RJ Connector	P. 8-1
M Series Sensor Connector M12	P. 3-1		

Fuel Cell Technologies			
Circular Connector	P. 1-1	RJ Connector	P. 8-1
USB Connector	P. 4-1	PV AC Connectors / T-Junction Connector	P. 15-1
RBL Connector	P.19-1		

* More available: BMC Series

UV Water Filtering			
Circular Connector	P. 1-1	D- SUB Connector	P. 6-1
Power Connector	P. 2-1	RJ Connector	P. 8-1
USB Connector	P. 4-1	RBL Connector	P.19-1
X-Lok Connector	P. 20-1		

* More available: T&Y Connectors, T&Y Splitters, Distribution Box

Electronic Faucets and Shower			
PPC Connector		Upon request	

Circular Connector





Circular Connector



Range Overview

Receptacle To Overmolded with Cable

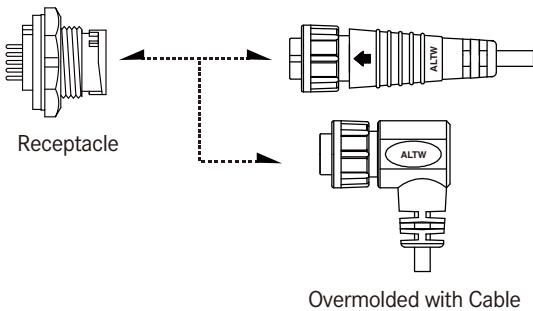

Receptacle To Field Installable

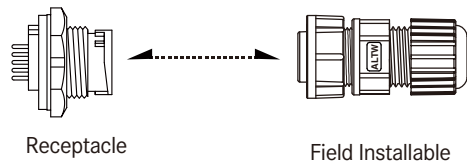

↘ Receptacle with Cable to Overmolded with Cable

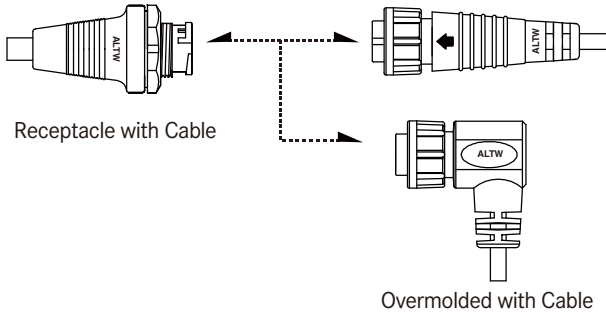



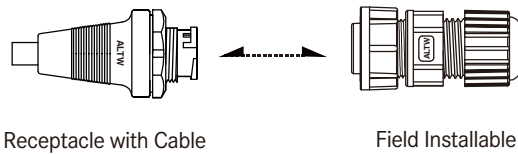

↘ Receptacle with Cable to Field Installable

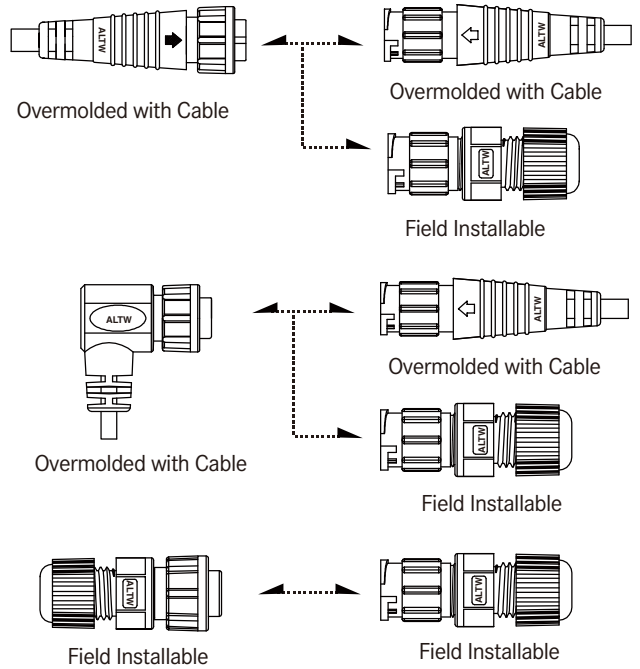

↘ In Line

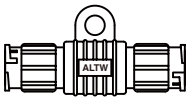
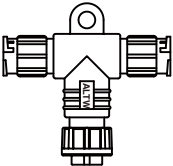
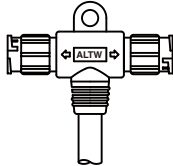

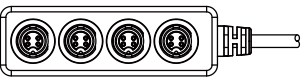
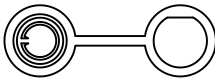
↘ Accessories

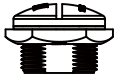
			
I Adaptor See page 21-7	T Adaptor See page 21-4	T Cable See page 21-1	Tool See page 21-22
			
Extension See page 21-19	Dust Cap See page 21-9	Waterproof Cap See page 21-11	Dummy See page 21-18

* Design and specification are subject to change without notice.

Specification

Identifications	A Size (Mini Size: 7/16"-28 UNS) B Size (Standard Size: 5/8"-27 UNS) C Size (Middle Size: 13/16"-28 UNS) D Size (Large Size: 1"-20 UNEF) E Size (Macro Size: 1 3/16" -20 UNS)
Description	Receptacle Receptacle with cable Overmolded with Cable Field Installable
Current Rating / Data	2A, 5A, 10A, 20A, 5A+2A, 10A+2A, 10A+5A, 20A+2A, 20A+5A
Material	Contacts: Copper Alloy, Gold Plated Connector Body (Housing) : Nylon+GF, UL Recognized
Waterproof Rating	IP66~68
Temperature Range	Receptacle: -40°C~105°C Receptacle with cable: -20°C~80°C Overmolded with Cable: -20°C~80°C Field installable: -40°C~105°C
Contact Resistance	≤ 10mΩ
Insulation Resistance	≥ 100MΩ at DC500V
Durability	1000 cycles
Breakdown Voltage	≥ AC1000V / 1 minute
More to know	Salt Spray Corrosion Test: 48H Standard Cable Length: 01~99M

Ordering Information

1 - 2 3 4 5 6 - 7 8 9 10

Specification / Current Rating

<u>>Mini Size</u> (AU) 2A (AD) 5A	<u>>Middle Size</u> (CU) 2A (CD) 5A (CB) 10A (CC) 20A (CDU) 5A+2A (CBU) 10A+2A (CBD) 10A+5A (CGU) 16A+2A	<u>>Macro Size</u> (ED) 5A <u>>Others</u> (GBD) 10A+5A (Between Standard Size & Middle Size) (MAB) 10A (Equivalent to AMP) (PLD) 5A (Size 12)
<u>>Mini Size Metal</u> (ASU) 2A (ASD) 5A	<u>>Large Size</u> (DU) 2A (DD) 5A (DC) 20A (DCU) 20A+2A (DCD) 20A+5A	
<u>>Standard Size</u> (BU) 2A (BD) 5A (BB) 10A (BDU) 5A+2A (BBD) 10A+5A	<u>>Large Size Metal</u> (DSD) 5A	
<u>>Standard Size Metal</u> (BSU) 2A (BSD) 5A (BSB) 10A		

Number of Contacts

02, 03.....
EX. (02) = 2 Contacts

Connector Body (Style)

<u>> For Receptacle</u> (P) Front Fastened (R) Rear Fastened	<u>> For Overmolded with Cable</u> (A) With Strain Relief (B) Without Strain Relief	<u>> For Field installable</u> (B) Without Strain Relief
---	--	--

Connector (Housing) Gender

(M) Male Connector (F) Female Connector

Contact Gender

(M) Male (Machine) (D) Female (Power) + Male (Signal) (Machine)
(F) Female (Machine) (E) Male (Power) + Female (Signal) (Machine)

Assemble Style

<u>> For Receptacle</u> (S) Solder Type (B) Screw in Type (P) 180° PCB Type (R) 90° PCB Type	<u>> For Overmolded with Cable</u> (M) Overmolded with Cable <u>> For Field Installable</u> (A) Field installable (Solder) (B) Screw in Type
---	--

Mating Style

(L) 2 Points Lock Bayonet (T) 3 Points Lock Bayonet
(S) Screw Thread (Q) Push Lock

Backshell

<u>> For Receptacle</u> (C) Circular (S) Square	<u>> For Overmolded with Cable</u> (L) Straight (R) Right Angle	<u>> For Field Installable</u> (L) Straight
--	--	---

Waterproof Rating

(6) IP 66
(7) IP 67
(8) IP 68

More Information

(C00) Similar Standard with TC-ER Cable > For Overmolded with Cable
(□)+(■) : Cable Type + Cable Length
EX. (A01) = UL2464 Cable + 1M

> For Receptacle
(001), (002).....
Without Cable : Different Versions

(□) : Cable Type (A) UL2464 Cable (B) UL2586 Cable (C) Power Cable(TC-ER)	(■) : Cable Length From 1M to 99M EX. (01) = 1M
--	---

* Design and specification are subject to change without notice.

Physical Dimension

Receptacle Panel Cut-Out

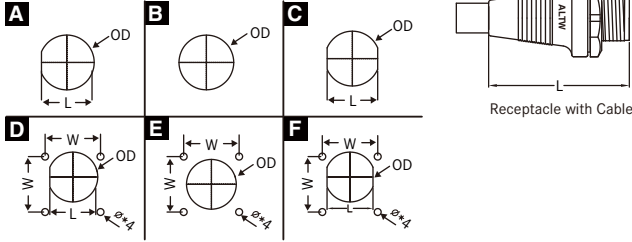

Connector Dimension

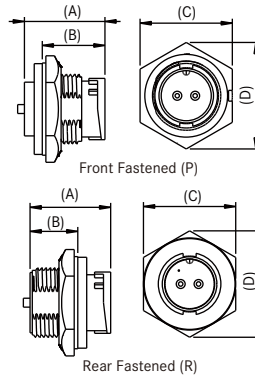

Overmolded with Cable

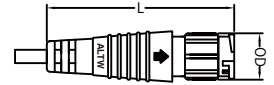

with Strain Relief / Straight

Current Rating		Dimension		Type	L / W	OD	φ	L (Connector Body)
Size	Metal	Connector Gender	Male					
Mini Size	-	2A(AU)	A	10.4	10.9	-	-	40.5
	-	2A(ASU)	D	10.4 / 12.7	10.9	3.05	-	-
	Metal	2A(ASU)	D	10.4 / 12.7	10.9	3.05	-	-
	-	5A(AD)	A	10.4	10.9	-	-	40.5
-	Metal	5A(ASD)	D	10.4 / 12.7	10.9	3.05	-	-
Standard Size	-	2A(BU)	A	14.8	15.6	-	-	42.6
	Metal	2A(BSU)	B	-	15.6	-	-	-
			C	14.0	16.0	-	-	
	-	5A(BD)	A	14.8	15.6	-	-	42.6
	Metal	5A(BSD)	B	-	15.6	-	-	-
			E	16.0	15.6	3.1	-	
	-	5A+2A(BDU)	A	14.8	15.6	-	-	42.6
	-	10A(BB)	A	14.8	15.6	-	-	42.6
	Metal	10A(BSB)	C	14.1	15.6	-	-	-
			A	14.8	15.6	-	-	42.6
-	10A+5A(BBD)	A	14.8	15.6	-	-	42.6	
Middle Size	-	2A(CU)	A	19.4	20.8	-	-	-
	-	5A(CD)	A	19.4	20.8	-	-	47.0
	-	5A+2A(CDU)	A	19.4	20.8	-	-	-
	-	10A(CB)	A	19.4	20.8	-	-	47.0
	-	10A+2A(CBU)	A	19.4	20.8	-	-	-
	-	10A+5A(CBD)	A	19.4	20.8	-	-	59.5
	-	20A(CC)	A	19.4	20.8	-	-	47.0
Large Size	-	2A(DU)	A	23.6	25.6	-	-	-
	-	5A(DD)	A	23.6	25.6	-	-	-
	Metal	5A(DD)	D	23.6 / 24.4	25.6	3.1	-	-
			E	24.8 / 24.5	24.8	3.1	-	
			F	23.2 / 24.5	25.6	3.1	-	
	-	20A(DC)	A	23.6	25.6	-	-	-
	-	20A(DC)	D	23.6 / 24.4	25.6	3.1	-	-
	-	20A+2A(DCU)	A	23.6	25.6	-	-	-
-	20A+5A(DCD)	A	23.6	25.6	-	-	-	
Macro Size	-	5A(ED)	D	29.0 / 30.1	30.1	3.5	-	-
Others	-	10+5A(GBD)	-	-	-	-	-	-
	-	10A(MAB)	-	-	-	-	-	-
	-	5A(PLD)	C	11.3	12.8	-	-	-

A	B	C	D	Panel Thickness Max	
				Lock Type	Screw Type
P: 18.4 R: 18.0	P: 14.0 R: 10.8	15.7	18.1	P: 3.5 R: 5.0	P: 5.0 R: 5.0
18.6	14.0	15.7	18.1	P: 3.5	-
P: 18.4 R: 18.0	P: 14.0 R: 10.8	15.7	18.1	P: 3.5 R: 5.0	P: 5.0 R: 5.0
18.6	14.0	15.7	18.1	P: 3.5	-
P: 18.0 R: 18.0	P: 14.0 R: 10.65	20.6	23.5	P: 4.5 R: 5.0	P: 4.0 R: 5.0
P: 18.8 R: 19.8	P: 16.3 R: 11.3	22.0	25.4	-	P: 5.0 R: 7.0
P: 18.0 R: 18.0	P: 14.0 R: 10.65	20.6	25.4	P: 4.5 R: 5.0	P: 4.0 R: 5.0
P: 18.0 R: 19.8	P: 14.0 R: 11.3	P: 21.0 R: 22.0	P: 23.9 R: 25.4	-	P: 4.4 R: 7.0
P: 18.0 R: 18.0	P: 14.0 R: 10.65	20.6	23.5	P: 4.5 R: 5.0	P: 4.0 R: 5.0
P: 18.0 R: 18.0	P: 14 R: 10.65	20.6	23.5	P: 4.5 R: 5.0	P: 4.0 R: 5.0
19.8	11.3	22.0	25.4	-	R: 7.0
P: 18.0 R: 18.0	P: 14.0 R: 10.65	20.6	23.8	P: 4.5 R: 5.0	P: 4.0 R: 5.0
17.0	14.0	25.4	29.3	P: 4.0	P: 3.0
P: 17.0 R: 18.0	P: 14.0 R: 10.0	25.4	29.3	P: 4.0 R: 4.0	P: 3.0 R: 4.0
18.0	14.0	25.4	29.3	P: 4.0	P: 3.0
P: 17.0 R: 18.0	P: 14.0 R: 10.0	25.4	29.3	P: 4.0 R: 4.0	P: 3.0 R: 4.0
18.0	15.0	25.4	29.3	P: 4.0	-
19.5	F: 15 R: 11.5	25.4	29.3	P: 4.0	P: 3.0
P: 17.0 R: 18.0	P: 14.0 R: 10.0	25.4	29.3	P: 4.0 R: 4.0	P: 3.0 R: 4.0
18.0	14.8	28.5	33.0	P: 4.0	-
P: 18.0 R: 18.0	P: 14.9 R: 10.3	28.5	33.0	P: 4.0 R: 4.0	P: 4.0 R: 4.0
17.9	14.6	29.0	33.5	-	P: 3.5
18.0	14.6	29.0	33.4	-	P: 3.5
P: 18.0 R: 18.0	P: 14.9 R: 10.3	28.5	33.0	P: 4.0 R: 4.0	P: 4.0 R: 4.0
18.8	14.8	28.5	33.0	P: 4.0	-
19	P: 14.9 / R: 10.8	28.5	33.0	P: 4.0 / R: 3.5	P: 4.0 / R: 3.5
17.6	14.9	34.9	4.0	P: 3.5	-
-	-	-	-	-	-
-	-	-	-	-	-
15.9	13.4	15.8	17.3	P: 3.0	-

L		OD	
Female	Male	Female	Male
43.5	44.5	15.2	13.5
-	-	-	-
43.5	44.5	15.2	13.5
-	-	-	-
55.5	59.0	S: 20.0 L: 18.0	14.6
-	-	-	-
55.5	59.0	S: 20.0 L: 18.0	14.6
-	-	-	-
55.5	59.0	S: 20.0 L: 18.0	14.6
-	-	-	-
43.0	59.0	S: 20.0 L: 18.0	14.6
60.0	-	L: 22.2 S: 25.4	-
60.0	60.0	L: 22.2 S: 25.4	20.0
60.5	-	L: 22.2 S: 25.4	-
60.0	-	L: 22.2 S: 25.4	-
60.3	-	23.0	-
60.0	-	L: 22.2 S: 25.4	-
60.0	-	L: 22.2 S: 25.4	-
60.0	-	L: 22.2 S: 25.4	-
59.5	-	S: 32.0 L: 28.5	-
59.5	59.5	S: 32.0 L: 28.5	22.5
-	-	-	-
-	-	-	-
59.5	-	S: 32.0 L: 28.5	-
63.5	69.7	28.5	22.5
59.5	59.5	S: 32.0 L: 28.5	S: 32.0 L: 28.5
70.0	-	33.3	-
68.7	73.5	26.6	25.0
61.5	61.5	23.0	19.4
-	-	-	-

Field installable

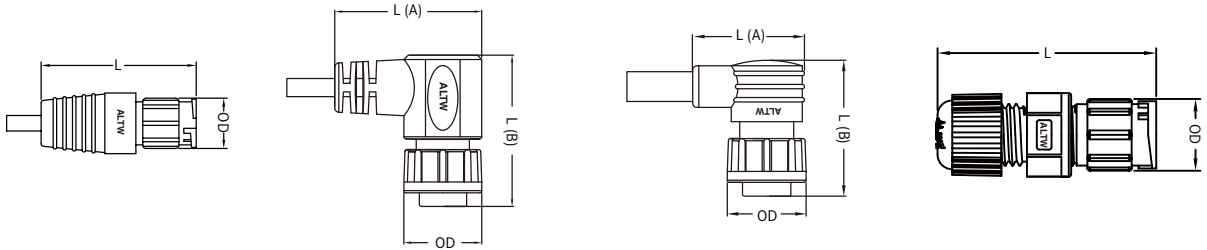

without Strain Relief / Straight

with Strain Relief / Right Angle

without Strain Relief / Right Angle

without Strain Relief / Straight

L		OD	
Female	Male	Female	Male
34.0	35.3	15.2	13.5
-	-	-	-
34.0	35.3	15.2	13.5
-	-	-	-
43.0	45.0	S-20.0 L-18.0	14.6
37.8	-	19.0	-
43.0	45.0	S-20.0 L-18.0	14.6
37.8	-	19.0	-
43.0	-	S-20.0 L-18.0	-
43.0	45.0	S-20.0 L-18.0	14.6
-	-	-	-
43.0	45.0	S-20.0 L-18.0	14.6
41.8	-	L-22.2 S-25.4	-
41.8	41.8	L-22.2 S-25.4	20.0
41.8	-	L-22.2 S-25.4	-
41.8	-	L-22.2 S-25.4	-
-	-	-	-
41.8	-	L-22.2 S-25.4	-
41.8	-	L-22.2 S-25.4	-
52.0	-	S-32.0 L-28.5	-
52.0	52.0	S-32.0 L-28.5	22.5
49.3	-	30.0	-
49.3	-	30.0	-
52.0	-	S32.0 L-28.5	-
-	-	-	-
-	-	-	-
60.2	65.0	26.6	25.0
53.0	53.0	23.0	19.4
-	-	-	-

L [A]		L [B]		OD	
Female	Male	Female	Male	Female	Male
-	-	-	-	-	-
-	-	-	-	-	-
-	-	-	-	-	-
34.0	-	35.0	-	S-20.0 L-18.0	-
-	-	-	-	-	-
34.0	-	35.0	-	S-20.0 L-18.0	-
-	-	-	-	-	-
34.0	-	35.0	-	S-20.0 L-18.0	-
34.0	-	35.0	-	S-20.0 L-18.0	-
-	-	-	-	-	-
34.0	-	35.0	-	S-20.0 L-18.0	-
-	-	-	-	-	-
42.5	-	39.5	-	22.2	-
-	-	-	-	-	-
-	-	-	-	-	-
-	-	-	-	-	-
-	-	-	-	-	-
-	-	-	-	-	-
-	-	-	-	-	-
-	-	-	-	-	-
-	-	-	-	-	-
44.1	-	49.8	-	S-32.0 L-28.5	-
40.0	-	40.0	-	30.0	-
40.0	-	40.0	-	30.0	-
-	-	-	-	-	-
-	-	-	-	-	-
44.1	-	49.8	-	28.5	-
-	-	-	-	-	-
-	-	-	-	-	-
-	-	-	-	-	-
-	-	-	-	-	-
-	-	-	-	-	-
-	-	-	-	-	-

L [A]		L [B]		OD	
Female	Male	Female	Male	Female	Male
24.0	-	29.4	-	15.2	-
-	-	-	-	-	-
24.0	-	29.4	-	15.2	-
-	-	-	-	-	-
-	-	-	-	-	-
30.0	-	33.6	-	19.0	-
25.5	-	31.0	-	S-20.0 L-18.0	-
30.0	-	33.6	-	19.0	-
-	-	-	-	-	-
25.5	-	31.0	-	S-20.0 L-18.0	-
-	-	-	-	-	-
25.5	-	31.0	-	S-20.0 L-18.0	-
-	-	-	-	-	-
-	-	-	-	-	-
-	-	-	-	-	-
-	-	-	-	-	-
-	-	-	-	-	-
-	-	-	-	-	-
-	-	-	-	-	-
-	-	-	-	-	-
-	-	-	-	-	-
40.0	-	40.0	-	30.0	-
40.0	-	40.0	-	30.0	-
-	-	-	-	-	-
-	-	-	-	-	-
-	-	-	-	-	-
-	-	-	-	-	-
-	-	-	-	-	-
-	-	-	-	-	-
-	-	-	-	-	-
-	-	-	-	-	-
-	-	-	-	-	-
-	-	-	-	-	-
-	-	-	-	-	-
-	-	-	-	-	-

L		OD	
Female	Male	Female	Male
41.5	41.5	15.2	13.5
-	-	-	-
41.5	41.5	15.2	13.5
-	-	-	-
44.0	43.0	S-20.0 L-18.0	14.6
-	-	-	-
43.0	43.0	S-20.0 L-18.0	14.6
-	-	-	-
43.0	-	S-20.0 L-18.0	-
43.0	43.0	S-20.0 L-18.0	14.6
-	-	-	-
43.0	43.0	S-20.0 L-18.0	14.6
48.2	-	L-22.2 S-25.4	-
48.2	48.65	L-22.2 S-25.4	20.0
-	-	-	-
48.2	-	L-22.2 S-25.4	-
49.7	-	23.0	-
-	-	-	-
48.2	-	L-22.2 S-25.4	-
-	-	-	-
-	-	-	-
54.9	54.9	S-32.0 L-28.5	23.0
-	-	-	-
-	-	-	-
54.9	54.9	S-32.0 L-28.5	23.0
62.8	59.3	L-28.5	23.0
59.9	59.9	L-28.5	23.0
-	-	-	-
-	-	-	-
-	-	-	-
39.2	35.3	15.0	15.0

Dimensions are shown in millimeters

















* Design and specification are subject to change without notice.

Contact Configuration

	Mini Size (A)						Standard Size (B)							
	2A(AU)(ASU)		5A(AD)		5A(ASD)		2A(BU)(BSU)		5A(BD)		5A(BSD)		10A(BB)	
4 5	MM or FF	MF or FM	MM or FF	MF or FM	MM or FF	MF or FM	MM or FF	MF or FM	MM or FF	MF or FM	MM or FF	MF or FM	MM or FM	MF or FM
2 Pin														
			R C F		R				R C F	R C F	R C F		R C F	R C F
3 Pin														
			R C F						R C F	R C F	R C F		R C F	R C F
4 Pin														
	R C F								R C F	R C F	R C F		R C F	
5 Pin														
	R C F								R C F	R C F	R C F			
6 Pin														
	R C F								R C F	R C F	R C F			
7 Pin														
									R C F		R C F			
8 Pin														
									R C F		R C F			
9 Pin														
10 Pin														
							R C F							
12 Pin														
							R C F							
14 Pin														
18 Pin														
20 Pin														
21 Pin														
22 Pin														
31 Pin														

* Standard Size Metal (BSU): 10 Contact

Contact Configuration

	Middle Size (C)						Middle Size (C)				Large Size (D)			
	10A(CB)		20A(CC)		5A+2A(CDU)		10A+5A(CBD)		10A+2A(CBU)		2A(DU)		5A(DD)(DSD)	
4 5	MM or FF	MF or FM	MM or FF	MF or FM	MM or FF	MF or FM	MM or FF	MF or FM	MM or FF	MF or FM	MM or FF	MF or FM	MM or FF	MF or FM
2 Pin														
3 Pin														
			R C F											
4 Pin														
	R C F	R C F												
5 Pin														
	R C F	R C F												
6 Pin														
	R C F													
7 Pin														
8 Pin														
							R C	R C	R C F	R C F				
9 Pin														
10 Pin														
12 Pin														
						R C F								
14 Pin														
						R C F								
18 Pin														
												R C F	R C F	
20 Pin														
											R C F			
21 Pin														
											R C F			
22 Pin														
											R C F			
31 Pin														

Large Size (D)						Marco Size (E)		Other Size					
20A(DC)		20A+2A(DCU)		20A+5A(DCD)		5A(ED)		10A+5A(GBD)		10A(MAB)		5A(PLD)	
MM or FF	MF or FM	MM or FF	MF or FM	MM or FF	MF or FM	MM or FF	MF or FM	MM or FF	MF or FM	MM or FF	MF or FM	MM or FF	MF or FM
R C F													R F
R C F												R C F	R F
R C F										R C F			R F
R C F													
R C F									C				
		R C F	R C F										
				R C F	R C F								
									R C				

* Design and specification are subject to change without notice.

Product Features

Receptacle

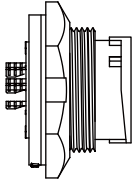

Flange 8

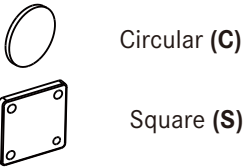

Mating Style 7

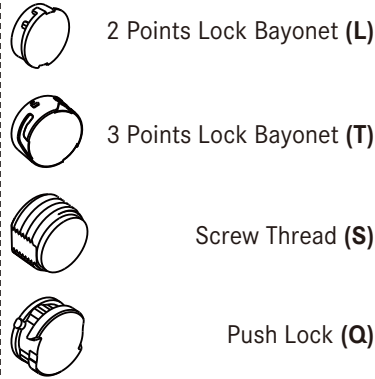

Connector Body(Style) 3

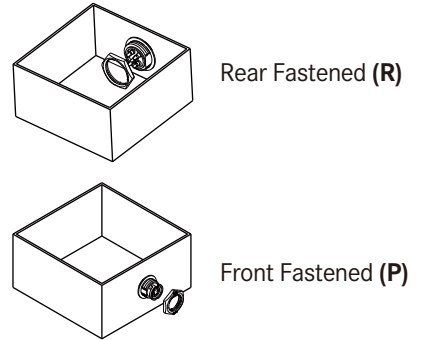

Overmolded with Cable

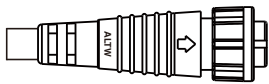

Backshell 8

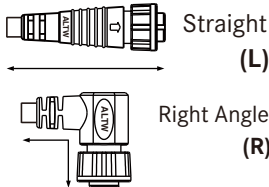

Mating Style 7

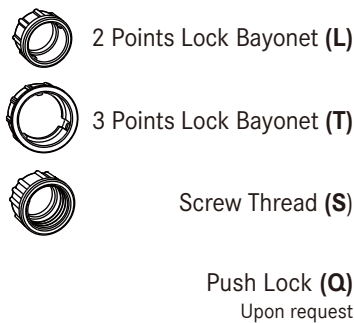

Connector Body(Style) 3

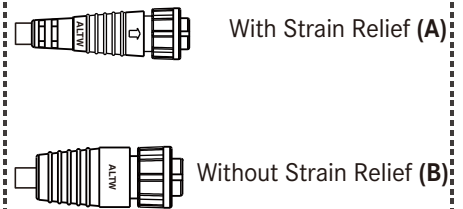

Field Installable

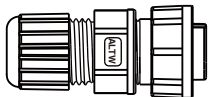

Backshell 8



Mating Style 7

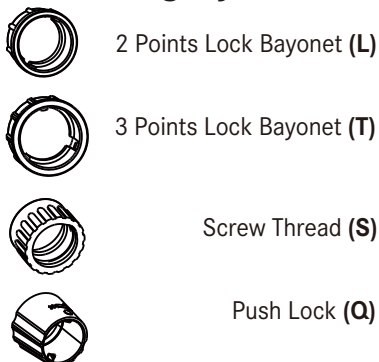

Connector Body(Style) 3

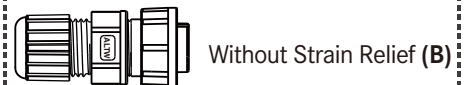

Find Our Standard Products

Mini Size: 7/16"-28 UNS > In-line

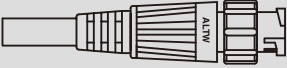
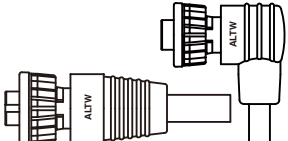
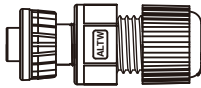
<ul style="list-style-type: none"> • Male Connector (Housing) • Male Contacts • 2 Points Lock Bayonet 		<p>Overmolded with Cable</p>  <p>** Select cable length from 01~99m</p>	<p>Overmolded with Cable</p>  <p>** Select cable length from 01~99m</p>	<p>Field Installable</p> 
Current Rating (Code)	Contacts 2	Male Connector (M) Male Contacts (M)	Female Connector (F) Female Contacts (F)	Female Connector (F) Female Contacts (F)
2A (AU)	04,05,06	AU- 2 AMMM-LL6A** AU- 2 BMMM-LL7A**	AU- 2 AFFM-LL6A** AU- 2 BFFM-LL7A** AU- 2 BFFM-LR6A**	AU- 2 BFFA-LL7001
5A (AD)	02,03	AD- 2 AMMM-LL6A** AD- 2 BMMM-LL7A**	AD- 2 AFFM-LL6A** AD- 2 BFFM-LL7A** AD- 2 BFFM-LR6A**	AD- 2 BFFA-LL7001

Mini Size: 7/16"-28 UNS > In-line

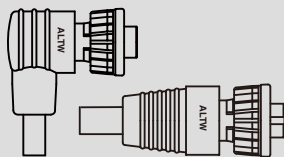
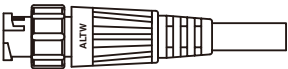
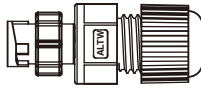
<ul style="list-style-type: none"> • Female Connector (Housing) • Female Contacts • 2 Points Lock Bayonet 		<p>Overmolded with Cable</p>  <p>**Select cable length from 01~99m</p>	<p>Overmolded with Cable</p>  <p>**Select cable length from 01~99m</p>	<p>Field Installable</p> 
Current Rating (Code)	Contacts 2	Female Connector (F) Female Contacts (F)	Male Connector (M) Male Contacts (M)	Male Connector (M) Male Contacts (M)
2A (AU)	04,05,06	AU- 2 AFFM-LL6A** AU- 2 BFFM-LL7A** AU- 2 BFFM-LR6A**	AU- 2 AMMM-LL6A** AU- 2 BMMM-LL7A**	AU- 2 BMMA-LL7001
5A (AD)	02,03	AD- 2 AFFM-LL6A** AD- 2 BFFM-LL7A** AD- 2 BFFM-LR6A**	AD- 2 AMMM-LL6A** AD- 2 BMMM-LL7A**	AD- 2 BMMA-LL7001

* Design and specification are subject to change without notice.

Mini Size: 7/16"-28 UNS > Receptacle and Mating Pair

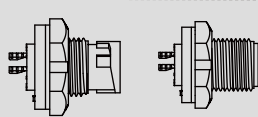
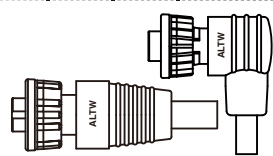
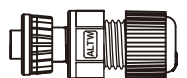
<ul style="list-style-type: none"> • Male Connector (Housing) • Male Contacts • Screw Thread & 2 Points Lock Bayonet 		<p>Receptacle</p>  <ul style="list-style-type: none"> 7 2 Points Lock Bayonet (L) 7 Screw Thread (S) 6 Choose the PCB Type (P/R) or Solder Type (S) 8 Choose the backshell circular (C) or square flange (S). 10 Choose Plastic (001) or Metal Nut (002) 	<p>Overmolded with Cable</p>  <ul style="list-style-type: none"> 7 Choose 2 Points Lock Bayonet (L) or Screw Thread (S) <p>**Select cable length from 01-99m</p>	<p>Field Installable</p>  <ul style="list-style-type: none"> 7 Choose 2 Points Lock Bayonet (L) or Screw Thread (S)
Current Rating (Code)	Contacts 2	Male Connector (M) Male Contacts (M)	Female Connector (F) Female Contacts (F)	Female Connector (F) Female Contacts (F)
2A (AU)	04,05,06	AU-2 PMM 6-7 8 7001 AU-2 RMMS - 7 C7001	AU-2 AFFM-7 L6A** AU-2 BFFM-7 L7A** AU-2 BFFM-7 R6A**	AU-2 BFFA-7 L7001
2A (ASU)	04,05,06	ASU-2 PMMS- LS70010	AU-2 AFFM-LL6A** AU-2 BFFM-LL7A** AU-2 BFFM-LR6A**	AU-2 BFFA-LL7001
5A (AD)	02,03	AD-2 PMM 6-7 8 7001 AD-2 RMMS - 7 C70010	AD-2 AFFM-7 L6A** AD-2 BFFM-7 L7A** AD-2 BFFM-7 R6A**	AD-2 BFFA-7 L7001
5A (ASD)	02,03	ASD-2 PMM 6-LS70010	AD-2 AFFM-LL6A** AD-2 BFFM-LL7A** AD-2 BFFM-LR6A**	AD-2 BFFA-LL7001

Mini Size: 7/16"-28 UNS > Receptacle with Overmolded Cable and Mating Pair

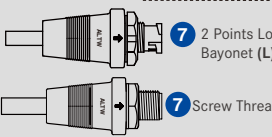
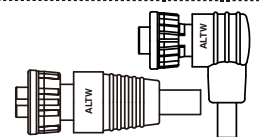
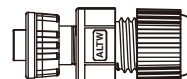
<ul style="list-style-type: none"> • Male Connector (Housing) • Male Contacts • Screw Thread & 2 Points Lock Bayonet 		<p>Receptacle</p>  <ul style="list-style-type: none"> 7 2 Points Lock Bayonet (L) 7 Screw Thread (S) <p>**Select cable length from 01-99m</p>	<p>Overmolded with Cable</p>  <ul style="list-style-type: none"> 7 Choose 2 Points Lock Bayonet (L) or Screw Thread (S) <p>**Select cable length from 01-99m</p>	<p>Field Installable</p>  <ul style="list-style-type: none"> 7 Choose 2 Points Lock Bayonet (L) or Screw Thread (S)
Current Rating (Code)	Contacts 2	Male Connector (M) Male Contacts (M)	Female Connector (F) Female Contacts (F)	Female Connector (F) Female Contacts (F)
2A (AU)	04,05,06	AU-2 PMMM-7 L7A**	AU-2 AFFM-7 L6A** AU-2 BFFM-7 L7A** AU-2 BFFM-7 R6A**	AU-2 BFFA-7 L7001
5A (AD)	02,03	AD-2 PMMM-7 L7A**	AD-2 AFFM-7 L6A** AD-2 BFFM-7 L7A** AD-2 BFFM-7 R6A**	AD-2 BFFA-7 L7001

Standard Size: 5/8"-27 UNS > In-line

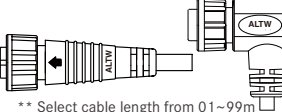
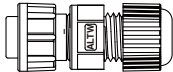
<ul style="list-style-type: none"> • Male Connector (Housing) • Male Contacts • 2 Points Lock Bayonet 		Overmolded with Cable 	Overmolded with Cable 	Field Installable 
		<small>** Select cable length from 01-99m</small>		
Current Rating (Code)	Contacts 2	Male Connector (M) Male Contacts (M)	Female Connector (F) Female Contacts (F)	Female Connector (F) Female Contacts (F)
2A (BU)	10, 12	BU- 2 AMMM-LL6A** BU- 2 BMMM-LL7A**	BU- 2 AFFM-LL6A** BU- 2 AFFM-LR7A** BU- 2 BFFM-LL7A** BU- 2 BFFM-LR6A**	BU- 2 BFFA-LL7001
5A (BD)	02,03,04, 05,06,07,08	BD- 2 AMMM-LL6A** BD- 2 BMMM-LL7A**	BD- 2 AFFM-LL6A** BD- 2 AFFM-LR7A** BD- 2 BFFM-LL7A** BD- 2 BFFM-LR6A**	BD- 2 BFFA-LL7001
10A (BB)	02,03,04	BB- 2 AMMM-LL6A** BB- 2 BMMM-LL7A**	BB- 2 AFFM-LL6A** BB- 2 AFFM-LR7A** BB- 2 BFFM-LL7A** BB- 2 BFFM-LR6A**	BB- 2 BFFA-LL7001

Standard Size: 5/8"-27 UNS > In-line

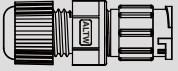
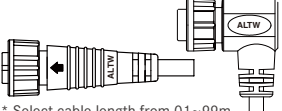
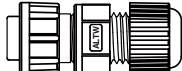

<ul style="list-style-type: none"> • Male Connector (Housing) • Male Contacts • 2 Points Lock Bayonet 		Field Installable 	Overmolded with Cable 	Field Installable 
		<small>** Select cable length from 01-99m</small>		
Current Rating (Code)	Contacts 2	Male Connector (M) Male Contacts (M)	Female Connector (F) Female Contacts (F)	Female Connector (F) Female Contacts (F)
2A (BU)	10, 12	BU- 2 BMMA-LL7001	BU- 2 AFFM-LL6A** BU- 2 AFFM-LR7A** BU- 2 BFFM-LL7A** BU- 2 BFFM-LR6A**	BU- 2 BFFA-LL7001
5A (BD)	02,03,04, 05,06,07,08	BD- 2 BMMA-LL7001	BD- 2 AFFM-LL6A** BD- 2 AFFM-LR7A** BD- 2 BFFM-LL7A** BD- 2 BFFM-LR6A**	BD- 2 BFFA-LL7001
10A (BB)	02,03,04	BB- 2 BMMA-LL7001	BB- 2 AFFM-LL6A** BB- 2 AFFM-LR7A** BB- 2 BFFM-LL7A** BB- 2 BFFM-LR6A**	BB- 2 BFFA-LL7001

* Design and specification are subject to change without notice.

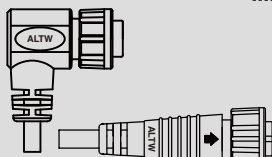
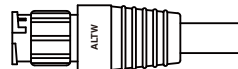
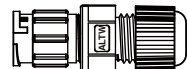

Standard Size: 5/8"-27 UNS > In-line

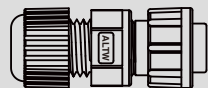
<ul style="list-style-type: none"> Female Connector (Housing) Female Contacts 2 Points Lock Bayonet 		<p>Overmolded with Cable →</p>  <p>** Select cable length from 01~99m</p>	<p>Overmolded with Cable →</p>  <p>** Select cable length from 01~99m</p>	<p>Field Installable</p> 
Current Rating (Code)	Contacts 2	Female Connector (F) Female Contacts (F)	Male Connector (M) Male Contacts (M)	Male Connector (M) Male Contacts (M)
2A (BU)	10, 12	BU- 2 AFFM-LL6A** BU- 2 AFFM-LR7A** BU- 2 BFFM-LL7A** BU- 2 BFFM-LR6A**	BU- 2 AMMM-LL6A** BU- 2 BMMM-LL7A**	BU- 2 BMMA-LL7001
5A (BD)	02,03,04, 05,06,07,08	BD- 2 AFFM-LL6A** BD- 2 AFFM-LR7A** BD- 2 BFFM-LL7A** BD- 2 BFFM-LR6A**	BD- 2 AMMM-LL6A** BD- 2 BMMM-LL7A**	BD- 2 BMMA-LL7001
10A (BB)	02,03,04	BB- 2 AFFM-LL6A** BB- 2 AFFM-LR7A** BB- 2 BFFM-LL7A** BB- 2 BFFM-LR6A**	BB- 2 AMMM-LL6A** BB- 2 BMMM-LL7A**	BB- 2 BMMA-LL7001

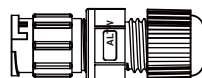
Standard Size: 5/8"-27 UNS > In-line

<ul style="list-style-type: none"> Female Connector (Housing) Female Contacts 2 Points Lock Bayonet 		<p>Field Installable →</p> 	<p>Overmolded with Cable →</p>  <p>** Select cable length from 01~99m</p>	<p>Field Installable</p> 
Current Rating (Code)	Contacts 2	Female Connector (F) Female Contacts (F)	Male Connector (M) Male Contacts (M)	Male Connector (M) Male Contacts (M)
2A (BU)	10, 12	BU- 2 BFFA-LL7001	BU- 2 AMMM-LL6A** BU- 2 BMMM-LL7A**	BU- 2 BMMA-LL7001
5A (BD)	02,03,04, 05,06,07,08	BD- 2 BFFA-LL7001	BD- 2 AMMM-LL6A** BD- 2 BMMM-LL7A**	BD- 2 BMMA-LL7001
10A (BB)	02,03,04	BB- 2 BFFA-LL7001	BB- 2 AMMM-LL6A** BB- 2 BMMM-LL7A**	BB- 2 BMMA-LL7001

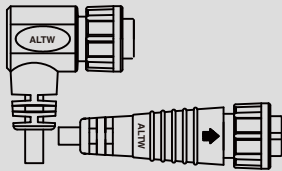
Standard Size: 5/8"-27 UNS > In-line

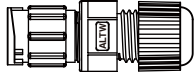
<ul style="list-style-type: none"> Female Connector (Housing) Male Contacts 2 Points Lock Bayonet 		<p>Overmolded with Cable →</p>  <p>** Select cable length from 01-99m</p>	<p>Overmolded with Cable →</p>  <p>** Select cable length from 01-99m</p>	<p>Field Installable</p> 
Current Rating (Code)	Contacts 2	Female Connector (F) Male Contacts (M)	Male Connector (M) Female Contacts (F)	Male Connector (M) Female Contacts (F)
5A (BD)	02,03,04,05,06	BD- 2 AFMM-LL6A** BD- 2 AFMM-LR7A** BD- 2 BFMM-LL7A** BD- 2 BFMM-LR6A**	BD- 2 AMFM-LL6A** BD- 2 BMFM-LL7A**	BD- 2 BMFA-LL7001
10A (BB)	02,03	BB- 2 AFMM-LL6A** BB- 2 AFMM-LR7A** BB- 2 BFMM-LL7A** BB- 2 BFMM-LR6A**	BB-02AMFM-LL6AXX BB-02BMFM-LL7AXX BB-03AMFM-LL6AXX BB-03BMFM-LL7AXX	BB-02BMFA-LL7001 BB-03BMFA-LL7001
5A+2A (BDU)	08 (2+6)	BDU-08AFMM-LL6A** BDU-08AFMM-LR7A** BDU-08BFMM-LL7A**	BDU-08AMFM-LL6AXX* BDU-08BMFM-LL7AXX*	BDU-08BMFA-LL7001
10A+5A (BBD)	06 (2+4)	BBD- 2 AFMM-LL6A** BBD- 2 AFMM-LR7A** BBD- 2 BFMM-LL7A** BBD- 2 BFMM-LR6A**	BBD-06AMFM-LL6A** BBD-06BMFM-LL7A**	BBD-06BMFA-LL7001

★ Upon request

* Design and specification are subject to change without notice.

Standard Size: 5/8"-27 UNS > Receptacle and Mating Pair

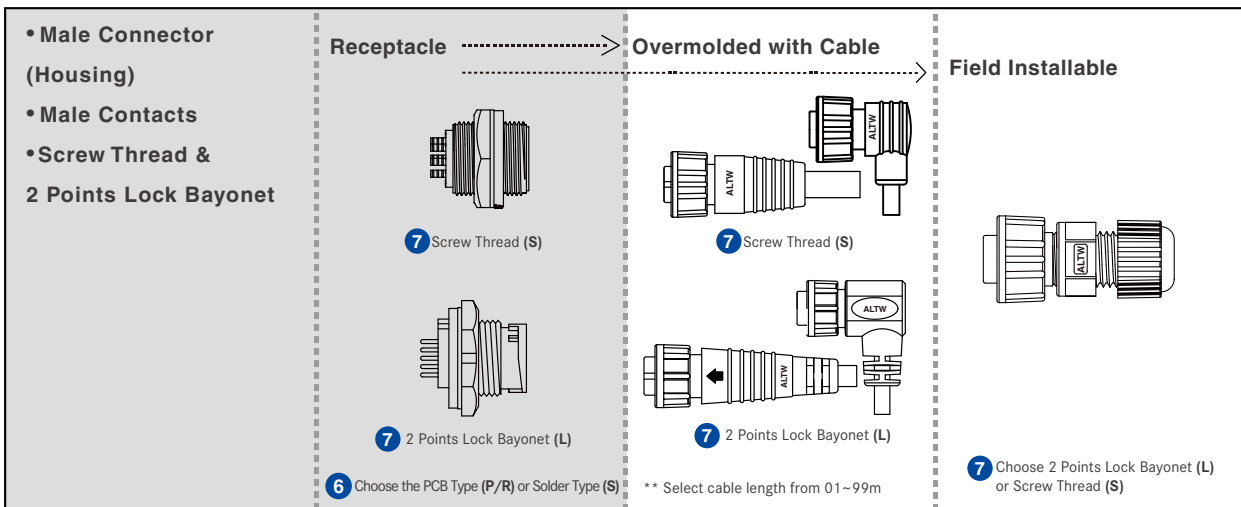

Current Rating (Code)	Contacts 2	Male Connector (M) Male Contacts (M)	Female Connector (F) Female Contacts (F)	Female Connector (F) Female Contacts (F)
2A (BU)	10, 12	BU- 2 PMM 6 - 7 C7001 BU- 2 RMMS - 7 C7001	BU- 2 AFFM- 7 L6A** BU- 2 AFFM- 7 R7A** BU- 2 BFFM- 7 L7A** BU- 2 BFFM-LR6A**	BU- 2 BFFA- 7 L7001
2A (BSU)	10	BSU- 2 PMM 6 -SC7001 BSU- 2 RMMS-SC7001	BSU-10BFFM-SL7A** BSU-10BFFM-SR6A**	BSU-10BFFA-SL7001
5A (BD)	02,03,04, 05,06,07,08	BD- 2 PMM 6 - 7 C7001 BD- 2 RMMS - 7 C7001 BD- 2 RMM 6 -LC7001	BD- 2 AFFM- 7 L6A** BD- 2 AFFM- 7 R7A** BD- 2 BFFM- 7 L7A** BD- 2 BFFM- 7 R6A**	BD- 2 BFFA- 7 L7001
5A (BSD)	04,05,06, 07,08	BSD- 2 PMM 6 -SC7001 BSD- 06RMMS-SC7001 BSD- 08RMMS-SC7001	BSD- 2 BFFM-SL6A** BSD- 2 BFFM-SR6A**	-
10A (BB)	02,03,04	BB- 2 PMM 6 - 7 C7001 BB- 2 RMMS- 7 C7001 BB- 2 RMM 6 -LC7001	BB- 2 AFFM- 7 L6A** BB- 2 AFFM- 7 R7A** BB- 2 BFFM- 7 L7A** BB- 2 BFFM- 7 R6A**	BB- 2 BFFA- 7 L7001
10A (BSB)	04	BSB-04RMMS-SC7001	BSB-04BFFM-SL7A**	-

Standard Size: 5/8"-27 UNS > Receptacle with Overmolded Cable and Mating Pair

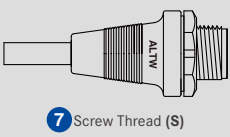
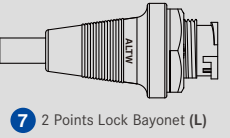
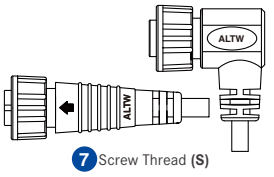
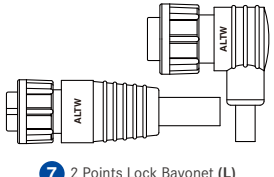
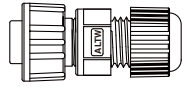
<ul style="list-style-type: none"> • Male Connector (Housing) • Male Contacts • Screw Thread & 2 Points Lock Bayonet 		<p>Receptacle</p>  <p>7 Screw Thread (S)</p>  <p>7 2 Points Lock Bayonet (L)</p> <p>** Select cable length from 01-99m</p>	<p>Overmolded with Cable</p>  <p>7 Screw Thread (S)</p>  <p>7 2 Points Lock Bayonet (L)</p> <p>** Select cable length from 01-99m</p>	<p>Field Installable</p>  <p>7 Choose 2 Points Lock Bayonet (L) or Screw Thread (S)</p>
Current Rating (Code)	Contacts 2	Male Connector (M) Male Contacts (M)	Female Connector (F) Female Contacts (F)	Female Connector (F) Female Contacts (F)
2A (BU)	10, 12	BU- 2 PMMM- 7 L7A**	BU- 2 AFFM- 7 L6A** BU- 2 AFFM- 7 R7A** BU- 2 BFFM- 7 L7A**	BU- 2 BFFA- 7 L7001
5A (BD)	02,03,04, 05,06,07,08	BD- 2 PMMM- 7 L7A**	BD- 2 AFFM- 7 L6A** BD- 2 AFFM- 7 R7A** BD- 2 BFFM- 7 L7A** BD- 2 BFFM- 7 R6A**	BD- 2 BFFA- 7 L7001
10A (BB)	02,03,04	BB- 2 PMMM- 7 L7A**	BB- 2 AFFM- 7 L6A** BB- 2 AFFM- 7 R7A** BB- 2 BFFM- 7 L7A** BB- 2 BFFM- 7 R6A**	BB- 2 BFFA- 7 L7001

* Design and specification are subject to change without notice.

Standard Size: 5/8"-27 UNS > Receptacle and Mating Pair

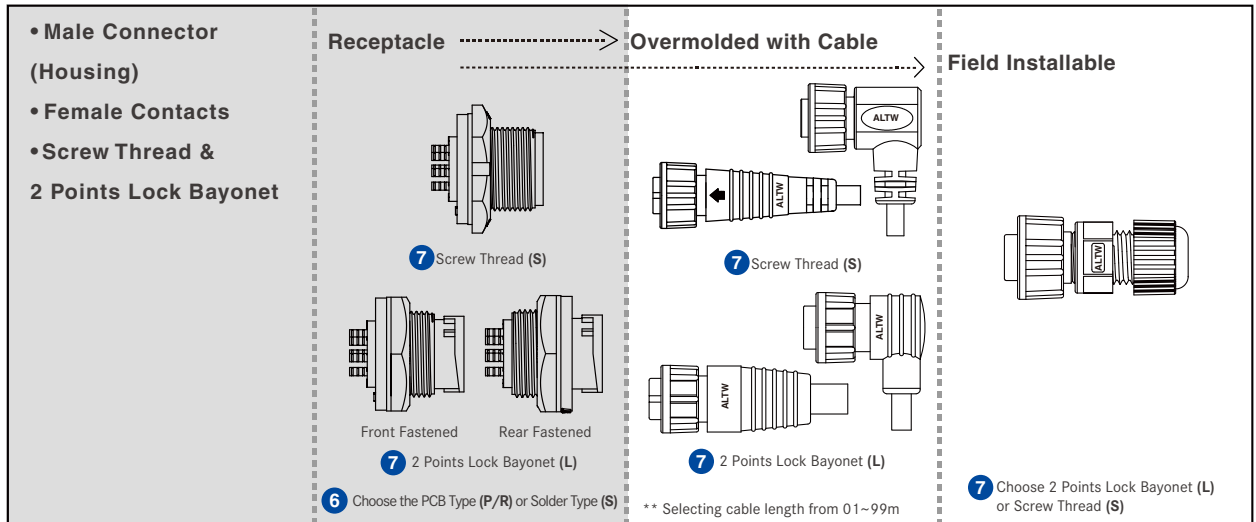

Current Rating (Code)	Contacts ²	Male Connector (M) Female Contacts (F)	Female Connector (F) Male Contacts (M)	Female Connector (F) Male Contacts (M)
5A (BD)	02,03,04, 05,06	BD- ² PMF ⁶ - ⁷ C7001 BD- ² RMFS- ⁷ C7001	BD- ² AFMM- ⁷ L6A** BD- ² AFMM- ⁷ R7A** BD- ² BFMM- ⁷ L7A** BD- ² BFMM- ⁷ R6A**	BD- ² BFMA- ⁷ L7001
10A (BB)	02,03	BB- ² PMF ⁶ - ⁷ C7001 BB- ² RMFS- ⁷ C7001	BB- ² AFMM- ⁷ L6A** BB- ² AFMM- ⁷ R7A** BB- ² BFMM- ⁷ L7A** BB- ² BFMM- ⁷ R6A**	BB- ² BFMA- ⁷ L7001
5A+2A (BDU)	08 (2+6)	BDU-08PMF ⁶ - ⁷ C7001 BDU-08RMFS- ⁷ C7001	BDU-08AFMM- ⁷ L6A** BDU-08AFMM- ⁷ R7A** BDU-08BFMM- ⁷ L7A**	BDU-08BFMA- ⁷ L7001
10A+5A (BBD)	06 (2+4)	BBD-06PMF ⁶ - ⁷ C7001 BBD-06RMFS- ⁷ C7001	BBD-06AFMM- ⁷ L6A** BBD-06AFMM- ⁷ R7A** BBD-06BFMM- ⁷ L7A** BBD-06BFMM- ⁷ R6A**	BBD-06BFMA- ⁷ L7001

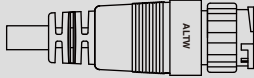
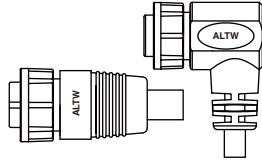
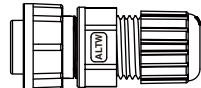

∟ Middle Size: 13/16"-28 UNS > In-line

<ul style="list-style-type: none"> • Male Connector (Housing) • Male Contacts • 2 Points Lock Bayonet 		<p>Overmolded with Cable →</p>  <p>* Select cable length from 01-99m</p>	<p>Overmolded with Cable →</p>  <p>* Select cable length from 01-99m</p>	<p>Field Installable</p> 
Current Rating (Code)	Contacts 2	Male Connector (M) Male Contacts (M)	Female Connector (F) Female Contacts (F)	Female Connector (F) Female Contacts (F)
5A (CD)	07,08,09, 10,12,14	CD- 2 AMMM-LL7A** CD- 2 BMMM-LL6A**	CD- 2 AFFM-LL7A** CD- 2 BFFM-LL6A** CD- 2 AFFM-LR7A**	CD- 2 BFFA-LL7001

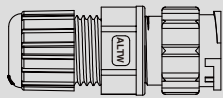
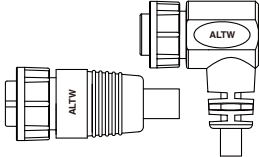
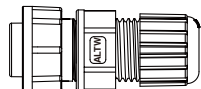
∟ Middle Size: 13/16"-28 UNS > In-line

<ul style="list-style-type: none"> • Male Connector (Housing) • Male Contacts • 2 Points Lock Bayonet 		<p>Field Installable →</p> 	<p>Overmolded with Cable →</p>  <p>* Select cable length from 01-99m</p>	<p>Field Installable</p> 
Current Rating (Code)	Contacts 2	Male Connector (M) Male Contacts (M)	Female Connector (F) Female Contacts (F)	Female Connector (F) Female Contacts (F)
5A (CD)	07,08,09, 10,12,14	CD- 2 BMMA-LL7001	CD- 2 AFFM-LL7A** CD- 2 AFFM-LR7A** CD- 2 BFFM-LL6A**	CD- 2 BFFA-LL7001

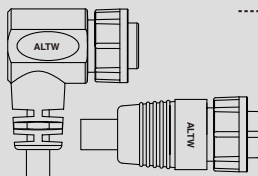
∟ Middle Size: 13/16"-28 UNS > In-line

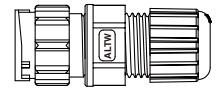
<ul style="list-style-type: none"> • Female Connector (Housing) • Female Contacts • 2 Points Lock Bayonet 		<p>Overmolded with Cable →</p>  <p>* Select cable length from 01-99m</p>	<p>Overmolded with Cable →</p>  <p>* Select cable length from 01-99m</p>	<p>Field Installable</p> 
Current Rating (Code)	Contacts 2	Female Connector (F) Female Contacts (F)	Male Connector (M) Male Contacts (M)	Male Connector (M) Male Contacts (M)
5A (CD)	07,08,09, 10,12,14	CD- 2 AFFM-LL7A** CD- 2 AFFM-LR7A** CD- 2 BFFM-LL6A**	CD- 2 AMMM-LL7A** CD- 2 BMMM-LL6A**	CD- 2 BMMA-LL7001

∨ Middle Size: 13/16"-28 UNS > In-line

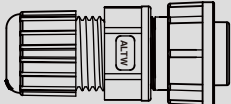
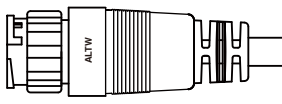
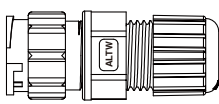
<ul style="list-style-type: none"> • Female Connector (Housing) • Female Contacts • 2 Points Lock Bayonet 		<p>Field Installable</p> 	<p>Overmolded with Cable</p> 	<p>Field Installable</p> 
Current Rating (Code)	Contacts 2	Female Connector (F) Female Contacts (F)	Male Connector (M) Male Contacts (M)	Male Connector (M) Male Contacts (M)
5A (CD)	07,08,09, 10,12,14	CD- 2 BFFA-LL7001	CD- 2 AMMM-LL7A** CD- 2 BMMM-LL6A**	CD- 2 BMMA-LL7001

** Select cable length from 01~99m

∨ Middle Size: 13/16"-28 UNS > In Line

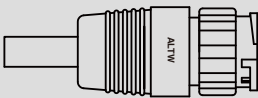
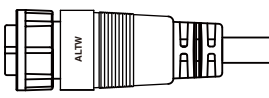
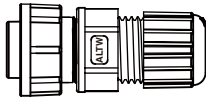
<ul style="list-style-type: none"> • Male Connector (Housing) • Female Contacts • 2 Points Lock Bayonet 		<p>Overmolded with Cable</p> 	<p>Overmolded with Cable</p> 	<p>Field Installable</p> 
Current Rating (Code)	Contacts 2	Male Connector (M) Female Contacts (F)	Female Connector (F) Male Contacts (M)	Female Connector (F) Male Contacts (M)
5A (CD)	07,08,09	CD- 2 AMFM-LL7A** CD- 2 BMFM-LL6A**	CD- 2 AFMM-LL7A** CD- 2 BFMM-LL6A**	CD- 2 BFMA-LL7001

** Select cable length from 01~99m

∨ Middle Size: 13/16"-28 UNS > In Line

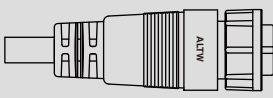
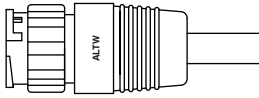
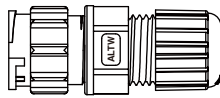
<ul style="list-style-type: none"> • Female Connector (Housing) • Male Contacts • 2 Points Lock Bayonet 		<p>Overmolded with Cable</p> 	<p>Overmolded with Cable</p> 	<p>Field Installable</p> 
Current Rating (Code)	Contacts 2	Female Connector (F) Male Contacts (M)	Male Connector (M) Female Contacts (F)	Male Connector (M) Female Contacts (F)
5A (CD)	07,08,09	CD- 2 AFMM-LL7A** CD- 2 BFMM-LL6A**	CD- 2 AMFM-LL7A** CD- 2 BMFM-LL6A**	CD- 2 BMFA-LL7001

** Select cable length from 01~99m

∨ Middle Size: 13/16"-28 UNS > Receptacle and Mating Pair

<ul style="list-style-type: none"> • Male Connector (Housing) • Male Contacts • Screw Thread & 2 Points Lock Bayonet 		<p>Receptacle</p> <p>Front Fastened Rear Fastened</p> <p>7 Screw Thread (S)</p> <p>7 2 Points Lock Bayonet (L)</p> <p>6 Choose PCB (P/R) or Solder Type (S)</p>	<p>Overmolded with Cable</p> <p>7 Screw Thread (S)</p> <p>7 2 Points Lock Bayonet (L)</p> <p>** Select cable length from 01-99m</p>	<p>Field Installable</p> <p>7 Choose 2 Points Lock Bayonet (L) or Screw Thread (S)</p>
Current Rating (Code)	Contacts 2	Male Connector (M) Male Contacts (M)	Female Connector (F) Female Contacts (F)	Female Connector (F) Female Contacts (F)
2A (CU)	18	CU-18PMMP- C7001 CU-18PMMP-SC7002	CU-18AFFM- 7 L7A** CU-18BFFM- 7 L6A**	CU-18BFFA- 7 L7001
5A (CD)	07,08,09, 10,12,14	CD- 2 PMM 6 - 7 C7001 CD- 2 RMMS- 7 C7001	CD- 2 AFFM- 7 L7A** CD- 2 BFFM- 7 L6A** CD- 2 AFFM-LR7A**	CD- 2 BFFA- 7 L7001
10A (CB)	04,05,06	CB- 2 PMM 6 - 7 C7001 CB- 2 RMMS- 7 C7001	CB- 2 AFFM- 7 L7A** CB- 2 BFFM- 7 L6A**	CB- 2 BFFA- 7 L7001
10A+5A (CBD)	08 (2+6)	CBD-08PMM 6 - 7 C7001	CBD-08AFFM- 7 L7A** CBD-08BFFM- 7 L6A**	CBD-08BFFA- 7 L7001
20A (CC)	03	CC-03PMM 6 - 7 C7001 CC-03RMMS- 7 C7001	CC-03AFFM- 7 L7A** CC-03BFFM- 7 L6A**	CC-03BFFA- 7 L7001

* Design and specification are subject to change without notice.

Middle Size: 13/16"-28 UNS

Receptacle with Overmolded Cable and Mating Pair
Screw Thread & 2 Points Lock Bayonet

IP 66 ~ 68 9
Unmated or Mated

▾ Middle Size: 13/16"-28 UNS > Receptacle with Overmolded Cable and Mating Pair

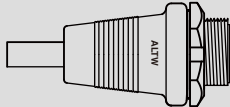
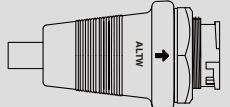
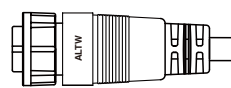
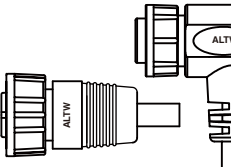
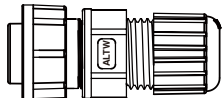
<ul style="list-style-type: none"> • Male Connector (Housing) • Male Contacts • Screw Thread & 2 Points Lock Bayonet 		<p>Receptacle</p>  <p>7 Screw Thread (S)</p>  <p>7 2 Points Lock Bayonet (L)</p> <p>** Select cable length from 01~99m</p>	<p>Overmolded with Cable</p>  <p>7 Screw Thread (S)</p>  <p>7 2 Points Lock Bayonet (L)</p> <p>** Select cable length from 01~99m</p>	<p>Field Installable</p>  <p>7 Choose 2 Points Lock Bayonet (L) or Screw Thread (S)</p>
		<p>Current Rating (Code)</p>	<p>Contacts 2</p>	<p>Male Connector (M) Male Contacts (M)</p>
5A (CD)	07,08,09,10,12,14	CD- 2 PMMM- 7 L7A**	CD- 2 AFFM- 7 L7A** CD- 2 BFFM- 7 L6A** CD- 2 AFFM-LR7A**	CD- 2 BFFA- 7 L7001
10A (CB)	04,05,06	CB- 2 PMMM- 7 L7A**	CB- 2 AFFM- 7 L7A** CB- 2 BFFM- 7 L6A**	CB- 2 BFFA- 7 L7001
20A (CC)	03	CC-03PMMM-SL7A**	CC-03AFFM-SL7A** CC-03BFFM-SL6A**	CC-03BFFA-SL7001

∟ Middle Size: 13/16"-28 UNS > Receptacle and Mating Pair

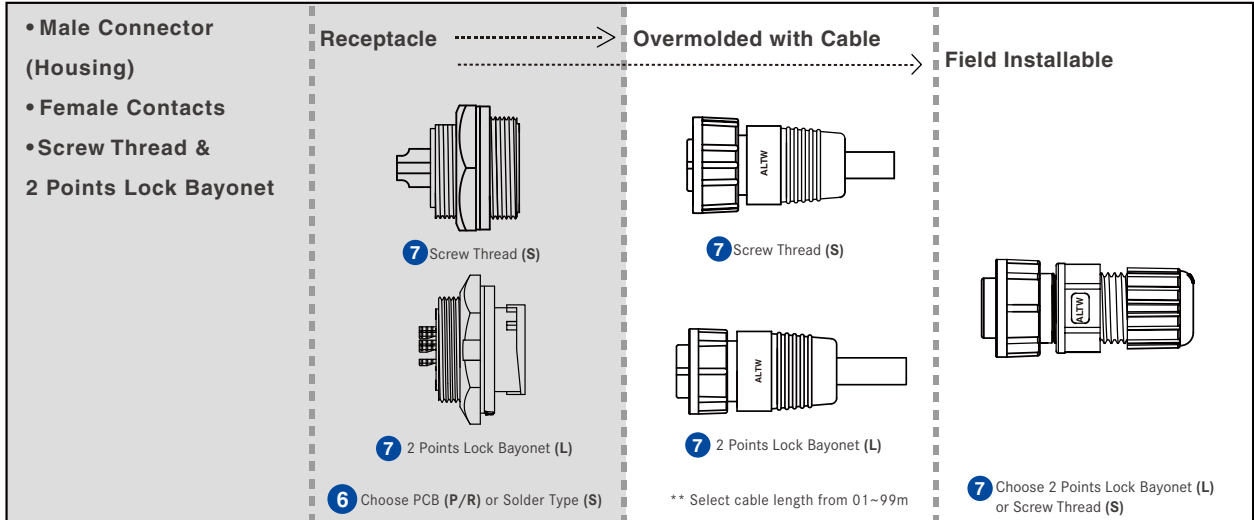

Current Rating (Code)	Contacts 2	Male Connector (M) Female Contacts (F)	Female Connector (F) Male Contacts (M)	Female Connector (F) Male Contacts (M)
5A (CD)	07,08,09	CD- 2 PMF 6 - 7 C7001 CD- 2 RMFS- 7 C7001	CD- 2 AFMM- 7 L7A** CD- 2 BFMM- 7 L6A**	CD- 2 BFMA- 7 L7001
5A+2A (CDU)	12 (2+10) 14 (2+12)	CDU- 2 PMF 6 - 7 C7001	CDU- 2 AFMM- 7 L7A** CDU- 2 BFMM- 7 L6A** CDU- 2 BFMM- 7 L7A**	CDU- 2 BFMA- 7 L7001
10A (CB)	04,05	CB- 2 PMF 6 - 7 C7001 CB- 2 RMFS- 7 C7001	CB- 2 AFMM- 7 L7A** CB- 2 BFMM- 7 L6A**	CB- 2 BFMA- 7 L7001
10A+5A (CBD)	08 (2+6)	CBD-08PMF 6 - 7 C7001	CBD-08AFMM- 7 L7A** CBD-08BFMM- 7 L6A**	CBD-08BFMA- 7 L7001
20A (CC)	02	CC-02PMFS- LC7001	CC-02AFMM- LL7A**	CC-02BFMA-LL7001

* Design and specification are subject to change without notice.

Middle Size: 13/16"-28 UNS

Receptacle with Overmolded Cable and Mating Pair
Screw Thread & 2 Points Lock Bayonet

IP 66 ~ 68 9
Unmated or Mated

▾ Middle Size: 13/16"-28 UNS > Receptacle with Overmolded Cable and Mating Pair

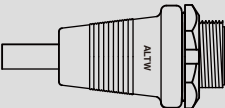
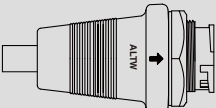
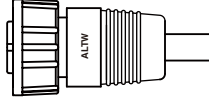
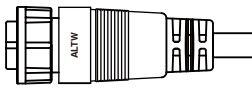
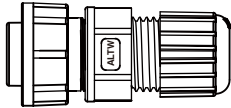
<ul style="list-style-type: none"> • Male Connector (Housing) • Female Contacts • Screw Thread & 2 Points Lock Bayonet 		<p>Receptacle</p>  <p>7 Screw Thread (S)</p>  <p>7 2 Points Lock Bayonet (L)</p> <p>** Select cable length from 01-99m</p>	<p>Overmolded with Cable</p>  <p>7 Screw Thread (S)</p>  <p>7 2 Points Lock Bayonet (L)</p> <p>** Select cable length from 01-99m</p>	<p>Field Installable</p>  <p>7 Choose 2 Points Lock Bayonet (L) or Screw Thread (S)</p>
		<p>Current Rating (Code)</p> <p>Contacts 2</p> <p>Male Connector (M) Female Contacts (F)</p>	<p>Female Connector (F) Male Contacts (M)</p>	<p>Female Connector (F) Male Contacts (M)</p>
5A (CD)	07,08,09	CD- 2 PMFM- 7 L7A**	CD- 2 AFMM- 7 L7A** CD- 2 BFMM- 7 L6A**	CD- 2 BFMA- 7 L7001
10A (CB)	04,05	CB- 2 PMFM- 7 L7A**	CB- 2 AFMM- 7 L7A** CB- 2 BFMM- 7 L6A**	CB- 2 BFMA- 7 L7001

➤ Middle Size: 13/16"-28 UNS > Receptacle and Mating Pair

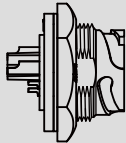
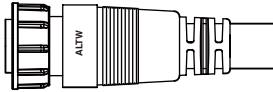
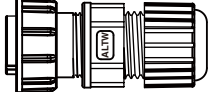
<ul style="list-style-type: none"> • Male Connector (Housing) • Female Power+Male Signal • 3 Points Lock Bayonet 		<p>Receptacle</p> 	<p>Overmolded with Cable</p>  <p>** Select cable length from 01-99m</p>	<p>Field Installable</p> 
Current Rating (Code)	Contacts	Male Connector (M) Female Power+Male Signal (D)	Female Connector (F) Male Power+Female Signal (E)	Female Connector (F) Male Power+Female Signal (E)
10A+2A (CBU)	(3+5)	CBU-08PMDS-TC7001	CBU-08AFEM-TL7A**	CBU-08BFEA-TL7001

➤ Middle Size: 13/16"-28 UNS > Receptacle and Mating Pair

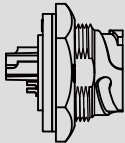
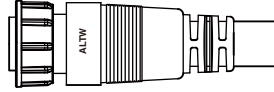
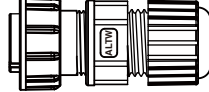

<ul style="list-style-type: none"> • Male Connector (Housing) • Male Power+Female Signal • 3 Points Lock Bayonet 		<p>Receptacle</p> 	<p>Overmolded with Cable</p>  <p>** Select cable length from 01-99m</p>	<p>Field Installable</p> 
Current Rating (Code)	Contacts	Male Connector (M) Male Power+Female Signal (E)	Female Connector (F) Female Power+Male Signal (D)	Female Connector (F) Female Power+Male Signal (D)
10A+2A (CBU)	(3+5)	CBU-08PMES-TC7001	CBU-08AFDM-TL7A**	CBU-08BFDA-TL7001

* Design and specification are subject to change without notice.

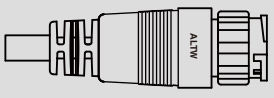
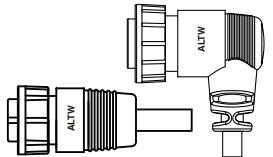
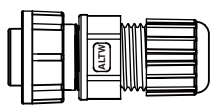
Large Size: 1"-20 UNEF > In-line

<ul style="list-style-type: none"> • Male Connector (Housing) • Male Contacts • 2 Points Lock Bayonet 		<p>Overmolded with Cable →</p>  <p>** Select cable length from 01~99m</p>	<p>Overmolded with Cable →</p>  <p>** Select cable length from 01~99m</p>	<p>Field Installable</p> 
Current Rating (Code)	Contacts	Male Connector (M) Male Contacts (M)	Female Connector (F) Female Contacts (F)	Female Connector (F) Female Contacts (F)
5A (DD)	18	DD-18AMMM-LL7A** DD-18BMMM-LL6A**	DD-18AFFM-LL7A** DD-18AFFM-LR7A** DD-18BFFM-LL6A**	DD-18BFFA-LL7001

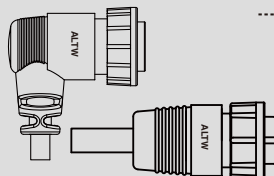
Large Size: 1"-20 UNEF > In-line

<ul style="list-style-type: none"> • Female Connector (Housing) • Female Contacts • 2 Points Lock Bayonet 		<p>Overmolded with Cable →</p>  <p>** Select cable length from 01~99m</p>	<p>Overmolded with Cable →</p>  <p>** Select cable length from 01~99m</p>	<p>Field Installable</p> 
Current Rating (Code)	Contacts	Female Connector (F) Female Contacts (F)	Male Connector (M) Male Contacts (M)	Male Connector (M) Male Contacts (M)
5A (DD)	18	DD-18AFFM-LL7A** DD-18AFFM-LR7A** DD-18BFFM-LL6A**	DD-18AMMM-LL7A** DD-18BMMM-LL6A**	DD-18BMMA-LL7001

Large Size: 1"-20 UNEF > In-line

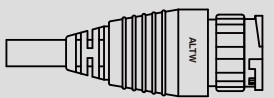
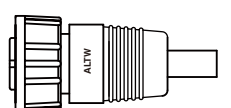
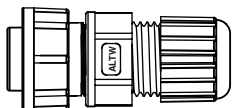
<ul style="list-style-type: none"> • Male Connector (Housing) • Female Contacts • 2 Points Lock Bayonet 		<p>Overmolded with Cable →</p>  <p>** Select cable length from 01~99m</p>	<p>Overmolded with Cable →</p>  <p>** Select cable length from 01~99m</p>	<p>Field Installable</p> 
Current Rating (Code)	Contacts	Male Connector (M) Female Contacts (F)	Female Connector (F) Male Contacts (M)	Female Connector (F) Male Contacts (M)
5A (DD)	18	DD-18AMFM-LL7A** DD-18BMFM-LL6A**	DD-18AFMM-LL7A** DD-18BFMM-LL6A**	DD-18BFMA-LL7001

↘ Large Size: 1"-20 UNEF > In-line

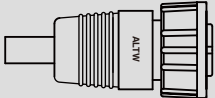
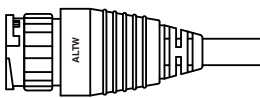
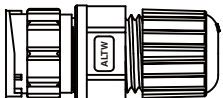
<ul style="list-style-type: none"> • Female Connector (Housing) • Male Contacts • 2 Points Lock Bayonet 		<p>Overmolded with Cable</p>  <p>** Select cable length from 01-99m</p>	<p>Overmolded with Cable</p>  <p>** Select cable length from 01-99m</p>	<p>Field Installable</p> 
Current Rating (Code)	Contacts	Female Connector (F) Male Contacts (M)	Male Connector (M) Female Contacts (F)	Male Connector (M) Female Contacts (F)
5A (DD)	18	DD-18AFMM-LL7A** DD-18BFMM-LL6A**	DD-18AMFM-LL7A** DD-18BMFM-LL6A**	DD-18BMFA-LL7001

↘ Large Size: 1"-20 UNEF > In-line

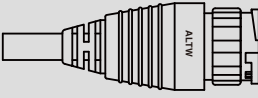
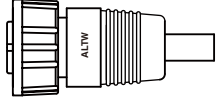
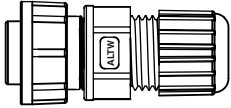
<ul style="list-style-type: none"> • Male Connector (Housing) • Female Power+Male Signal • 2 Points Lock Bayonet 		<p>Overmolded with Cable</p>  <p>** Select cable length from 01-99m</p>	<p>Overmolded with Cable</p>  <p>** Select cable length from 01-99m</p>	<p>Field Installable</p> 
Current Rating (Code)	Contacts	Male Connector (M) Female Power+Male Signal (D)	Female Connector (F) Male Power+Female Signal (E)	Female Connector (F) Male Power+Female Signal (E)
20A+2A (DCU)	(3+5)	DCU-08AMDM-LL7B**	DCU-08AFEM-LL7B**	DCU-08BFEA-LL7001
20A+5A (DCD)	(3+9)	DCD-12AMDM-LL7A**	DCD-12AFEM-LL7A** DCD-12AFEM-LR7A**	DCD-12BFEA-LL7001

↘ Large Size: 1"-20 UNEF > In-line

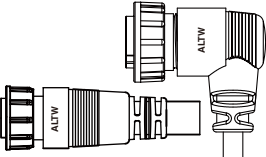
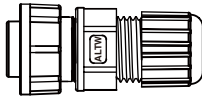
<ul style="list-style-type: none"> • Male Connector (Housing) • Female Power+Male Signal • 2 Points Lock Bayonet 		<p>Field Installable</p> 	<p>Overmolded with Cable</p>  <p>** Select cable length from 01-99m</p>	<p>Field Installable</p> 
Current Rating (Code)	Contacts	Male Connector (M) Female Power+Male Signal (D)	Female Connector (F) Male Power+Female Signal (E)	Female Connector (F) Male Power+Female Signal (E)
20A+2A (DCU)	(3+5)	DCU-08BMDA-LL7001	DCU-08AFEM-LL7B**	DCU-08BFEA-LL7001
20A+5A (DCD)	(3+9)	DCD-12BMDA-LL7001	DCD-12AFEM-LL7A** DCD-12AFEM-LR7A**	DCD-12BFEA-LL7001

* Design and specification are subject to change without notice.

➤ Large Size: 1"-20 UNEF > In-line

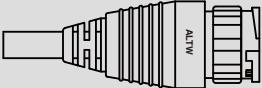
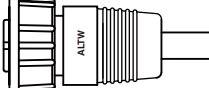
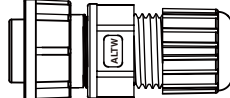
<ul style="list-style-type: none"> • Male Connector (Housing) • Male Power+Female Signal • 2 Points Lock Bayonet 		<p>Overmolded with Cable -----></p>  <p>** Select cable length from 01-99m</p>	<p>Overmolded with Cable -----></p>  <p>** Select cable length from 01-99m</p>	<p>Field Installable</p> 
		<p>Current Rating (Code)</p> <p>20A+2A (DCU)</p> <p>20A+5A (DCD)</p>	<p>Contacts</p> <p>(3+5)</p> <p>(3+9)</p>	<p>Male Connector (M) Male Power+Female Signal (E)</p> <p>DCU-08AMEM-LL7B**</p> <p>DCD-12AMEM-LL7A**</p>

➤ Large Size: 1"-20 UNEF > In-line

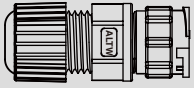
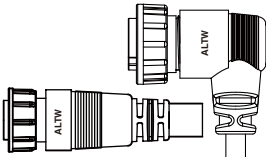
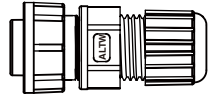
<ul style="list-style-type: none"> • Male Connector (Housing) • Male Power+Female Signal • 2 Points Lock Bayonet 		<p>Field Installable -----></p> 	<p>Overmolded with Cable -----></p>  <p>** Select cable length from 01-99m</p>	<p>Field Installable</p> 
		<p>Current Rating (Code)</p> <p>20A+2A (DCU)</p> <p>20A+5A (DCD)</p>	<p>Contacts</p> <p>(3+5)</p> <p>(3+9)</p>	<p>Male Connector (M) Male Power+Female Signal (E)</p> <p>DCU-08BMEA-LL7001</p> <p>DCD-12BMEA-LL7001</p>

Large Size: 1"-20 UNEF > Receptacle and Mating Pair

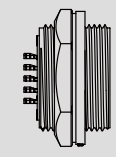
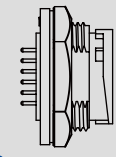
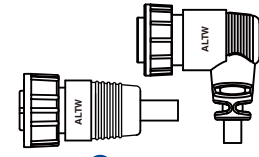
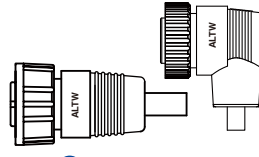
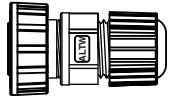
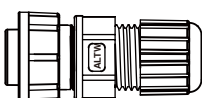
<ul style="list-style-type: none"> • Male Connector (Housing) • Male Contacts • Screw Thread & 2 Points Lock Bayonet 		<p>Receptacle</p>  <p>7 Screw Thread (S)</p>  <p>7 2 Points Lock Bayonet (L)</p> <p>6 Choose PCB (P/R) or Solder Type (S)</p>	<p>Overmolded with Cable</p>  <p>7 Screw Thread (S)</p>  <p>7 2 Points Lock Bayonet (L)</p> <p>** Select cable length from 01-99m</p>		<p>Field Installable</p>  <p>7 Screw Thread (S)</p>  <p>7 2 Points Lock Bayonet (L)</p>
		<p>Current Rating (Code)</p>	<p>Contacts 2</p>	<p>Male Connector (M) Male Contacts (M)</p>	<p>Female Connector (F) Female Contacts (F)</p>
2A (DU)	20,21,22	DU- 2 PMM 6 - 7 C7001	DU- 2 AFFM- 7 L7A** DU- 2 BFFM- 7 L6A**	DU- 2 BFFA-SL7001	
5A (DD)	18	DD-18PMM 6 - 7 C7001 DD-18RMMS- 7 C7001	DD-18AFFM- 7 L7A** DD-18AFFM- 7 R7A** DD-18BFFM- 7 L6A**	DD-18BFFA- 7 L7001	
20A (DC)	02,03,04, 05,06,07	DC- 2 PMM 6 - 7 C7001 DC- 2 PMM 6 - 7 S7001 DC- 2 RMMS- 7 C7001	DC- 2 AFFM- 7 L7A** DC- 2 BFFM- 7 L6A**	DC- 2 BFFA- 7 L7001 DC-02BFFB- 7 L7001	

* Design and specification are subject to change without notice.

Large Size: 1"-20 UNEF

Receptacle and Mating Pair
Screw Thread & 2 Points Lock Bayonet

↘ **Large Size: 1"-20 UNEF > Receptacle and Mating Pair**

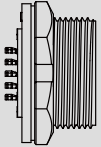
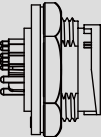
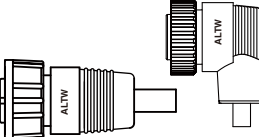
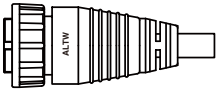
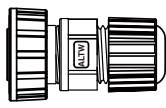
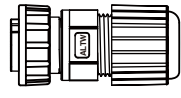
<ul style="list-style-type: none"> • Male Connector (Housing) • Female Contacts • Screw Thread & 2 Points Lock Bayonet 		<p>Receptacle</p>  <p>7 Screw Thread (S)</p>  <p>7 2 Points Lock Bayonet (L)</p> <p>6 Choose PCB (P/R) or Solder Type (S)</p>	<p>Overmolded with Cable</p>  <p>7 Screw Thread (S)</p>  <p>7 2 Points Lock Bayonet (L)</p> <p>** Select cable length from 01~99m</p>	<p>Field Installable</p>  <p>7 Screw Thread (S)</p>  <p>7 2 Points Lock Bayonet (L)</p>
		<p>Current Rating (Code)</p> <p>Contacts 2</p> <p>Male Connector (M) Female Contacts (F)</p>	<p>Female Connector (F) Male Contacts (M)</p>	<p>Female Connector (F) Male Contacts (M)</p>
5A (DD)	18	DD-18PMF 6 - 7 C7001 DD-18PMF 6 - 7 S7001 DD-18RMFS - 7 C7001	DD-18AFMM- 7 L7A** DD-18BFMM- 7 L6A**	DD-18BFMA- 7 L7001
5A (DSD)	18	DSD-18PMF 6 - SS8001 DSD-18PMF 6 - SS8002	DSD-18BFMM-SL6A** DSD-18BFMM-SR6A**	-
20A (DC)	02,03	DC- 2 PMFP- 7 C7001	DC- 2 AFMM- 7 L7AXX DC- 2 BFMM- 7 L6AXX	DC- 2 BFMB- 7 L7001

↘ Large Size: 1"-20UNEF > Receptacle and Mating Pair

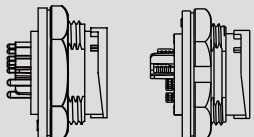
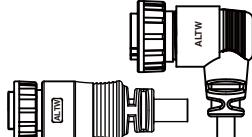
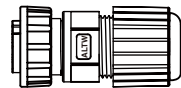
<ul style="list-style-type: none"> • Male Connector (Housing) • Female Power+Male Signal • 2 Points Lock Bayonet 		<p>Receptacle</p>  <p>PCB (P/R) Type Solder Type (S)</p> <p>6 Choose PCB (P/R) or Solder Type (S)</p>	<p>Overmolded with Cable</p>  <p>** Select cable length from 01-99m</p>	<p>Field Installable</p> 
Current Rating (Code)	Contacts	Male Connector (M) Female Power+Male Signal (D)	Female Connector (F) Male Power+Female Signal (E)	Female Connector (F) Male Power+Female Signal (E)
20A+2A (DCU)	(3+5)	DCU-08PMDS-LC7001	DCU-08AFEM-LL7B**	DCU-08BFEA-LL7001
20A+5A (DCD)	(3+9)	DCD-12PMD 6 -LC7001	DCD-12AFEM-LL7A** DCD-12AFEM-LR7A**	DCD-12BFEA-LL7001

↘ Large Size: 1"-20 UNEF > Receptacle and Mating Pair

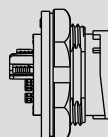
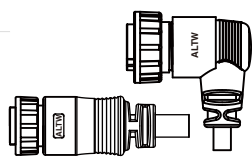
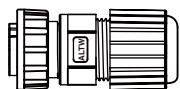
<ul style="list-style-type: none"> • Male Connector (Housing) • Male Power+Female Signal • 2 Points Lock Bayonet 		<p>Receptacle</p> 	<p>Overmolded with Cable</p>  <p>** Select cable length from 01-99m</p>	<p>Field Installable</p> 
Current Rating (Code)	Contacts	Male Connector (M) Male Power+Female Signal (E)	Female Connector (F) Female Power+Male Signal (D)	Female Connector (F) Female Power+Male Signal (D)
20A+2A (DCU)	(3+5)	DCU-08PMES-LC7001	DCU-08AFDM-LL7B**	DCU-08BFDA-LL7001
20A+5A (DCD)	(3+9)	DCD-12PMES-LC7001	DCD-12AFDM-LL7A** DCD-12AFDM-LR7A**	DCD-12BFDA-LL7001

↘ Macro Size: 1 3/16"-20 UNS > Receptacle and Mating pair

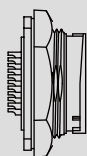
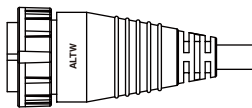
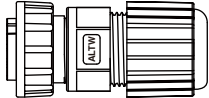
<ul style="list-style-type: none"> • Male Connector (Housing) • Female Contacts • 2 Points Lock Bayonet 		<p>Receptacle</p>  <p>6 Choose PCB (P) or Solder Type (S)</p>	<p>Overmolded with Cable</p>  <p>** Select cable length from 01-99m</p>	<p>Field Installable</p> 
Current Rating (Code)	Contacts	Male Connector (M) Female Contacts (F)	Female Connector (F) Male Contacts (M)	Female Connector (F) Male Contacts (M)
5A (ED)	31	ED-31PMF 6 -LS7001	ED-31AFMM-LL7A**	-

* Design and specification are subject to change without notice.

Other Size



In-line
2 & 3 Points Lock Bayonet

IP 66 ~ 68 9
Unmated or Mated

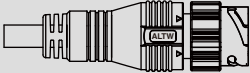
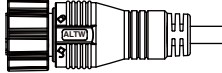
Other Size > In-line

<ul style="list-style-type: none"> • Male Connector (Housing) • Female Power+Male Signal • 3 Points Lock Bayonet 		<p>Receptacle</p>  <p>** Select cable length from 01~99m</p>	<p>Overmolded with Cable</p>  <p>** Select cable length from 01~99m</p>	<p>Field Installable</p>
Current Rating (Code)	Contacts	Male Connector (M) Male Contacts (M)	Female Connector (F) Female Contacts (F)	Female Connector (F) Female Contacts (F)
5A (GBD)	08	GBD-08AMMM-TL8A** GBD-08BMMM-TL7A**	GBD-08AFFM-TL8A** GBD-08BFFM-TL7A**	-

Other Size > In-line

<ul style="list-style-type: none"> • Male Connector (Housing) • Female Power+Male Signal • 2 Points Lock Bayonet 		<p>Receptacle</p>  <p>** Select cable length from 01~99m</p>	<p>Overmolded with Cable</p>  <p>** Select cable length from 01~99m</p>	<p>Field Installable</p>
Current Rating (Code)	Contacts	Male Connector (M) Female Contacts (F)	Female Connector (F) Male Contacts (M)	Female Connector (F) Male Contacts (M)
10A (MAB)	04	MAB-04AMFM-LL7A** MAB-04BMFM-LL6A**	MAB-04AFMM-LL7A** MAB-04BFMM-LL6A**	-

∟ **Other Size > Receptacle and Mating Pair**

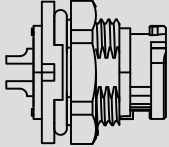
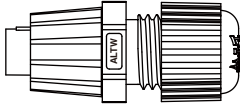
<ul style="list-style-type: none"> • Male Connector (Housing) • Female Contacts • Push Lock 		Receptacle 	Field Installable 	Field Installable
Current Rating (Code)	Contacts 2	Male Connector (M) Female Contacts (F)	Female Connector (F) Male Contacts (M)	Female Connector (F) Male Contacts (M)
5A (PLD)	02,03,04	PLD- 2 PMFS-QC7001	PLD- 2 BFMA-QL7001	-

∟ **Other Size > In-line**

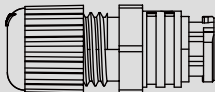
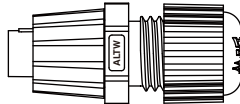
<ul style="list-style-type: none"> • Male Connector (Housing) • Female Contacts • Push Lock 		Field Installable 	Field Installable 	Field Installable
Current Rating (Code)	Contacts 2	Male Connector (M) Female Contacts (F)	Female Connector (F) Male Contacts (M)	Female Connector (F) Male Contacts (M)
5A (PLD)	02,03,04	PLD- 2 BMFA-QL7001	PLD- 2 BFMA-QL7001	-

* Design and specification are subject to change without notice.

Power Connector

PWE, PWF, PWG



PWC, PWCU



PWL



PWJ, PWH



PWCU



Range Overview

Receptacle to Overmolded with Cable

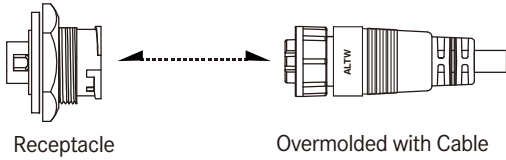

Receptacle to Field Installable

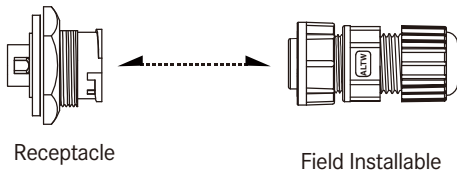

In Line

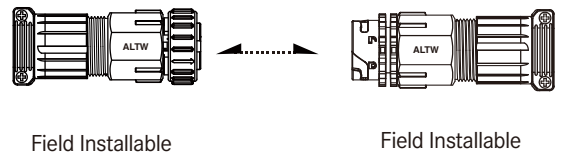
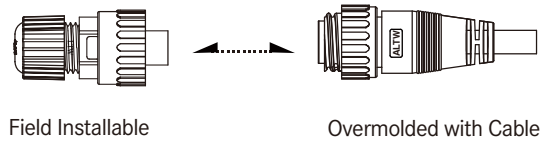
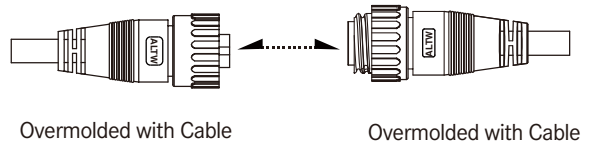

Accessories



Waterproof Cap
See page 21-13

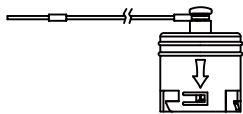

Waterproof Cap
See page 21-13

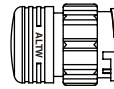

Waterproof Cap
See page 21-13

* Design and specification are subject to change without notice.

Specification

Identifications	Power Connector
Description	Receptacle Overmolded with Cable Field Installable
Current Rating / Data	8A, 12A, 16A, 20A, 25A, 30A, 10A+2A, 20A+2A
Material	Contacts: Copper Alloy, Gold Plated Connector Body (Housing) : Nylon+GF, UL Recognized, PPE
Waterproof Rating	IP66~68
Temperature Range	Receptacle : -40°C ~ +105°C Overmolded with Cable : -20°C ~ +80°C Field Installable : -40 °C~105 °C
Contact Resistance	≤ 5mΩ
Insulation Resistance	≥ 100MΩ at DC500V
Durability	500 cycles
Breakdown Voltage	≥ AC1000V / 1 minute
More to know	Standard Cable Length: 01~99M

Ordering Information

	1 — 2	3	4	5	6 — 7	8	9	10
Specification / Current Rating								
(PWE) 8A		(PWCU) 20A+2A						
(PWF) 12A		(PWG) 16A						
(PWC) 20A		(PWJ) 30A*						
(PWH) 25A		(PWL) 30A*						
Number of Contacts								
02, 03, 04, 05, 06, 07....								
EX. (02) = 2 Contacts								
Connector Body (Style)								
<u>> For Receptacle</u>			<u>> For Overmolded with Cable</u>					
(P) Front Fastened		(A) With Strain Relief						
(R) Rear Fastened		(B) Without Strain Relief						
<u>> For Field installable</u>								
(B) Without Strain Relief								
Connector (Housing) Gender								
(M) Male Connector			(F) Female Connector					
Contact Gender								
(M) Male (Machine)			(C) Combo (Machine)					
(F) Female (Machine)								
Assemble Style								
<u>> For Receptacle</u>			<u>> For Overmolded with Cable</u>					
(S) Solder Type		(M) Overmolded with Cable						
(B) Screw in Type		<u>> For Field Installable</u>						
(C) Crimp Type		(A) Field installable (Solder)						
		(B) Screw in Type						
		(C) Crimp Type						
Mating Style								
(S) Screw Thread			(L) 2 or 3 Points Lock Bayonet					
(T) 3 Points Lock Bayonet								
Backshell								
<u>> For Receptacle</u>			<u>> For Overmolded with Cable</u>			<u>> For Field Installable</u>		
(C) Circular		(L) Straight		(L) Straight				
(S) Square		(R) Right Angle		(R) Right Angle				
Waterproof Rating								
(6) IP 66								
(7) IP 67								
(8) IP 68								
More Information								
<u>> For Receptacle</u>			<u>> For Overmolded with Cable</u>			<u>> For Field Installable</u>		
001, 002, 003.....			(□)+(■) : Cable Type + Cable Length			(001) Cable OD range 12-16mm		
Without Cable : Different Versions			EX. (A01) = UL2464 Cable + 1M			(002) Cable OD range 09-12mm		
			(■) : Cable Type		(■) : Cable Length			
(A) UL2464 Cable		(D) SJTW Cable		From 1M to 99M				
(B) Power Cable(TC-ER)		(E) H05 Cable		EX. (01) = 1M				
(C) SJTOW Cable		(F) H07 Cable						

* 30A (PWJ) Recommended For Inverter Application

* 30A (PWL) Recommended For LED Application

* Design and specification are subject to change without notice.

Physical Dimension

Receptacle Cut-Out

Panel Cut-Out

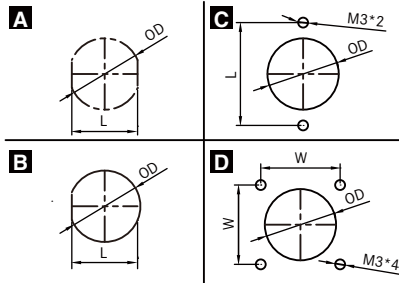

Connector(Housing) Gender Current Rating	Type	L / W		OD	
		Male		Female	
8A (PWE)	C	31.1	21.55	31.1	21.55
12A (PWF)	C	31.1	21.55	31.1	21.55
16A (PWG)	C	31.1	21.60	31.1	21.60
20A (PWC)	B	19.4	20.80	-	-
25A (PWH)	B	30.2	32.00	-	-
	A	23.2	25.20	-	-
20A+2A (PWCU)	B	19.4	20.80	-	-
30A (PWL)	D	23.0	23.00	-	-
30A (PWJ)	A	23.2	25.20	-	-

Dimensions are shown in millimeters

Connector Dimension

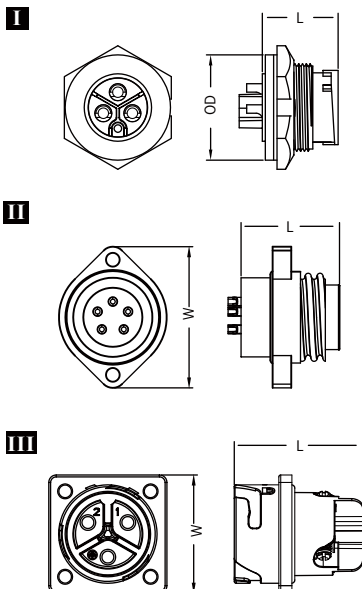

Connector(Housing) Gender Current Rating	Type	L		OD / W		Recommend Panel Thickness
		Female	Male	Female	Male	Female & Male
8A (PWE)	II	27.50	26.50	38.00	38.00	-
12A (PWF)	II	27.50	26.50	38.00	38.00	-
16A (PWG)	II	32.40	31.00	38.00	38.00	-
20A (PWC)	I	-	18.00	-	25.00	4.5 mm Max.
25A (PWH)	I	-	55.00	-	40.00	5.0 mm Max.
		-	47.00	-	35.00	0.5~8 mm
20A+2A (PWCU)	I	-	18.00	-	25.00	4.5 mm Max.
30A (PWL)	III	-	34.60	-	31.80	-
30A (PWJ)	I	-	47.00	-	35.00	0.5~8 mm

Dimensions are shown in millimeters

∟ **Overmolded with Cable**

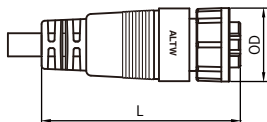

Connector(Housing) Gender Current Rating	L		OD	
	Female	Male	Female	Male
8A (PWE)	70.3	72.0	30.2	30.2
12A (PWF)	70.3	72.0	30.2	30.2
20A (PWC)	60.0	65.5	22.2 (L) 23.0 (T)	18.0
25A (PWH)	91.55	100.4	40.0	31.75
20A+2A (PWCU)	60.0	65.5	22.2	18.0

* (L) 2 Points Lock Bayonet | (T) 3 Points Lock Bayonet

∟ **Field Installable**

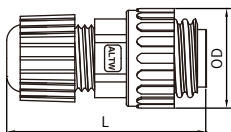

(See 3rd top-right hand chart)

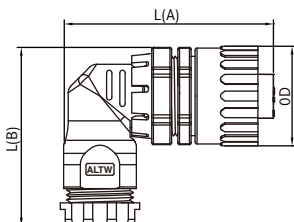

(See bottom right hand chart)









Connector(Housing) Gender Current Rating	L		OD	
	Female	Male	Female	Male
8A (PWE)	60.7	60.4	30.2	30.2
12A (PWF)	60.7	60.4	30.2	30.2
16A (PWG)	67.0	67.0	30.2	30.2
20A (PWC)	48.15	-	22.2	-
20A+2A (PWCU)	88.4	91.0	33.0	26.9
	48.15	-	22.2	-
25A (PWH)	87.4	84.1	38.0	38.0
30A (PWL)	92.14	-	35.2	-
30A (PWJ)	87.4	84.1	38.0	38.0

Connector(Housing) Gender Current Rating	L [A]	L [B]	OD
	Female / Male	Female / Male	Female / Male
16A (PWG)	62.0	54.0	30.2

Dimensions are shown in millimeters

* Design and specification are subject to change without notice.

Contact Configuration

	8A (PWE)		12A (PWF)		16A (PWG)		20A (PWC)	
	MM or FF	MF or FM	MM or FF	MF or FM	MM or FF	MF or FM	MM or FF	MF or FM
4 5								
2Contacts (02)			 R C F					
3Contacts (03)			 R C F				 R C	 R C
4Contacts (04)			 R C F		 F			
5Contacts (05)	 R C F							
6Contacts (06)	 R C F							
7Contacts (07)	 R C F							
12Contacts (12)								

25A (PWH)		20A+2A (PWCU)		30A (PWL)/(PWJ)	
MM or FF	MF or FM	MM or FF	MF or FM	MM or FF	MF or FM
R C				R F	R F
		R C F	R C F		
R F	R F				
			F		

R: receptacle
C: overmolded with cable
F: field installable

- 1**
- △ 8A (PWE)
 - 12A (PWF)
 - ◆ 16A (PWG)
 - ◇ 20A (PWC)
 - 25A (PWH)
 - 20A+2A (PWCU)
 - 30A (PWL)

Number of Contacts: **2**
 Ex.2 contacts (02)

Connector (Housing) Gender: **4**
 Male(M) or Female(F)

Contact Gender: **5**
 Male(M) or Female(F)

More to Choose: **6**

- Solder (S)
 - Solder Cup
 - Solder Contact



- Screw In (B)



- Crimped (C)

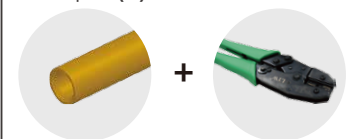

* Design and specification are subject to change without notice.

Product Features

┘ Receptacle

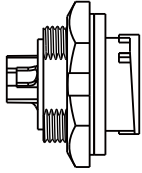

Backshell 8

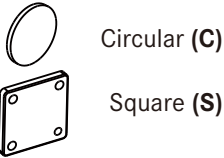

Mating Style 7

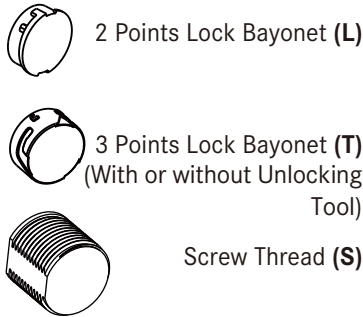

Connector Body(Style) 3

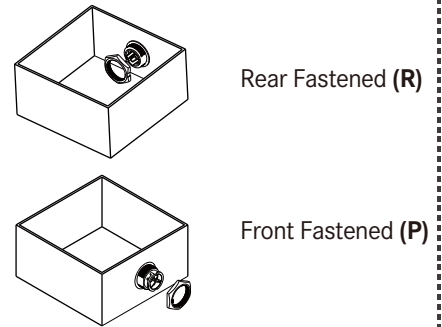

┘ Overmolded with Cable

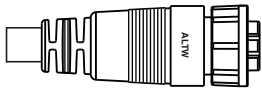

Backshell 8

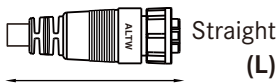

Mating Style 7

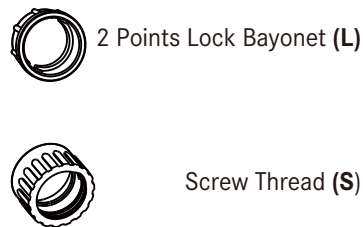

Connector Body(Style) 3

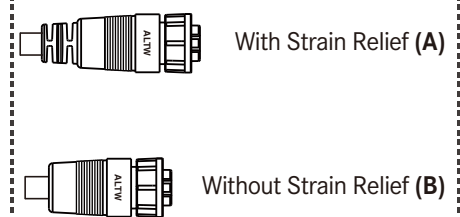

┘ Field Installable

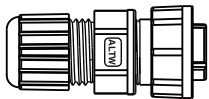

Backshell 8

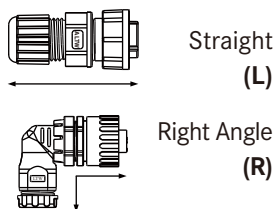

Mating Style 7

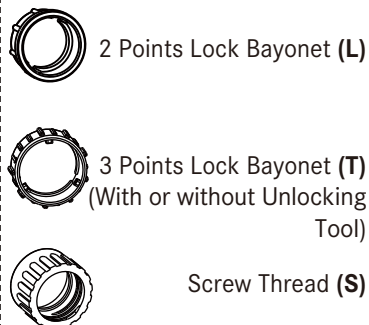



Connector Body(Style) 3



Find Our Standard Products

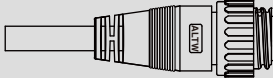

└ In-line

<ul style="list-style-type: none"> • Male Connector (Housing) • Male Contacts • Screw Thread 		<p>Overmolded with Cable</p>  <p>** Selecting the proper cable length from 1~99m for your connector</p>	<p>Overmolded with Cable</p>  <p>** Selecting the proper cable length from 1~99m for your connector</p>	<p>Field Installable</p> 
Current Rating (Code)	Contacts ②	Male Connector (M) Male Contacts (M)	Female Connector (F) Female Contacts (F)	Female Connector (F) Female Contacts (F)
8A (PWE)	05,06,07	PWE- ② AMMM-SL7A**	PWE- ② AFFM-SL7A**	PWE- ② BFFA-SL7001
12A (PWF)	02,03,04	PWF- ② AMMM-SL7A**	PWF- ② AFFM-SL7A**	PWF- ② BFFA-SL7001
25A (PWH)	03	PWH-03AMMM-SL7A**	PWH-03AFFM-SL7A**	-

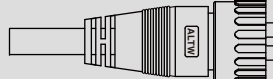
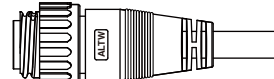
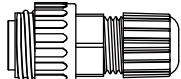
└ In-line

<ul style="list-style-type: none"> • Female Connector (Housing) • Female Contacts • Screw Thread 		<p>Overmolded with Cable</p>  <p>** Selecting the proper cable length from 1~99m for your connector</p>	<p>Overmolded with Cable</p>  <p>** Selecting the proper cable length from 1~99m for your connector</p>	<p>Field Installable</p> 
Current Rating (Code)	Contacts ②	Female Connector (F) Female Contacts (F)	Male Connector (M) Male Contacts (M)	Male Connector (M) Male Contacts (M)
8A (PWE)	05,06,07	PWE- ② AFFM-SL7A**	PWE- ② AMMM-SL7A**	PWE- ② BMMA-SL7001
12A (PWF)	02,03,04	PWF- ② AFFM-SL7A**	PWF- ② AMMM-SL7A**	PWF- ② BMMA-SL7001
25A (PWH)	03	PWH-03AFFM-SL7A**	PWH-03AMMM-SL7A**	-

└ In-line

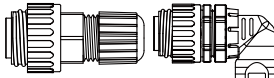
<ul style="list-style-type: none"> • Female Connector (Housing) • Female Contacts • Screw Thread 		<p>Field Installable</p>  <p>⑧ Choose straight (L) or right angle (R) *** Choose Pin Plated: Gold Plated (001) / Silver Plated (002) / Tin Plated (003)</p>	<p>Overmolded with Cable</p> 	<p>Field Installable</p>  <p>⑧ Choose straight (L) or right angle (R) *** Choose Pin Plated: Gold Plated (001) / Silver Plated (002) / Tin Plated (003)</p>
Current Rating (Code)	Contacts ②	Female Connector (F) Female Contacts (F)	Male Connector (M) Male Contacts (M)	Male Connector (M) Male Contacts (M)
8A (PWE)	05~07	PWE- ② BFFA-SL7001	-	PWE- ② BMMA-SL7001
12A (PWF)	02~04	PWF- ② BFFA-SL7001	-	PWF- ② BMMA-SL7001
16A (PWG)	04	PWG-04BFFB-S ⑧ 7***	-	PWG-04BMMB-S ⑧ 7***

* Design and specification are subject to change without notice.

↘ In-line

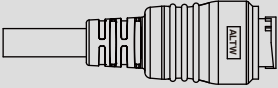
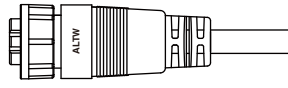
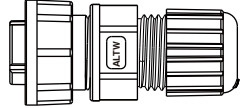
<ul style="list-style-type: none"> • Male Connector (Housing) • Male Contacts • 2 Points Lock Bayonet & 3 Points Lock Bayonet 		<p>Overmolded with Cable →</p>  <p>** Selecting the proper cable length from 1~99m for your connector</p>	<p>Overmolded with Cable →</p>  <p>** Selecting the proper cable length from 1~99m for your connector</p>	<p>Field Installable</p>  <p>*** Selecting UL (002) or Non-UL (001)</p>
Current Rating (Code)	Contacts	Male Connector (M) Male Contacts (M)	Female Connector (F) Female Contacts (F)	Female Connector (F) Female Contacts (F)
20A (PWC)	03	PWC-03AMMM-LL7A** PWC-03AMMM-LL7B** PWC-03AMMM-LL7D** PWC-03AMMM-LL7E** PWC-03BMMM-LL7D** PWC-03BMMM-LL7E** PWC-03AMMM-TL7A** PWC-03AMMM-TL7B**	PWC-03AFFM-LL7A** PWC-03AFFM-LL7B** PWC-03AFFM-LL7D** PWC-03AFFM-LL7E** PWC-03BFFM-LL7D** PWC-03BFFM-LL7E** PWC-03AFFM-TL7A** PWC-03AFFM-TL7B**	PWC-03BFFA-LL7*** PWC-03BFFA-TL7001
20A+2A (PWCU)	04	PWCU-04AMMM-LL7A** PWCU-04AMMM-LL7B** PWCU-04AMMM-TL7A** PWCU-04AMMM-TL7B**	PWCU-04AFFM-LL7A** PWCU-04AFFM-LL7B** PWCU-04AFFM-TL7A** PWCU-04AFFM-TL7B**	PWCU-04BFFA-LL7*** PWCU-04BFFA-TL7001

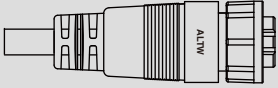
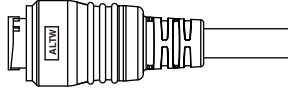

↘ In-line

<ul style="list-style-type: none"> • Female Connector (Housing) • Female Contacts • 2 Points Lock Bayonet 		<p>Overmolded with Cable →</p>  <p>** Selecting the proper cable length from 1~99m for your connector</p>	<p>Overmolded with Cable →</p>  <p>** Selecting the proper cable length from 1~99m for your connector</p>	<p>Field Installable</p>
Current Rating (Code)	Contacts	Female Connector (F) Female Contacts (F)	Male Connector (M) Male Contacts (M)	-
20A (PWC)	03	PWC-03AFFM-LL7A** PWC-03AFFM-LL7B** PWC-03AFFM-LL7D** PWC-03AFFM-LL7E**	PWC-03AMMM-LL7A** PWC-03AMMM-LL7B** PWC-03AMMM-LL7D** PWC-03AMMM-LL7E**	-
20A+2A (PWCU)	(1+3)	PWCU-04AFFM-LL7A** PWCU-04AFFM-LL7B**	PWCU-04AMMM-LL7A** PWCU-04AMMM-LL7B**	-

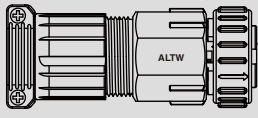
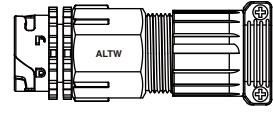
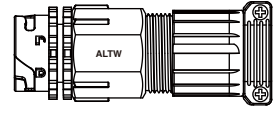
∟ In-line

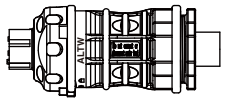
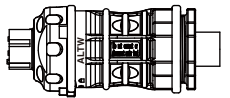

<ul style="list-style-type: none"> • Female Connector (Housing) • Female Contacts • 3 Points Lock Bayonet 		Field Installable 	Overmolded with Cable 	Field Installable 
Current Rating (Code)	Contacts	Female Connector (F) Female Contacts (F)	Male Connector (M) Male Contacts (M)	Male Connector (M) Male Contacts (M)
20A+2A (PWCU)	(6+6)	PWCU-12BFFA-TL7001	-	PWCU-12BMMA-TL7001

∟ In-line

<ul style="list-style-type: none"> • Male Connector (Housing) • Male Contacts • 3 Points Lock Bayonet • Unlock Tool Needed (Part Number: ANB00010649) 		Field Installable  <p>***Selecting the cable OD range 12~16mm (001) or OD 09~12mm (002)</p>	Overmolded with Cable  <p>***Selecting the cable OD range 12~16mm (001) or OD 09~12mm (002)</p>	Field Installable  <p>***Selecting the cable OD range 12~16mm (001) or OD 09~12mm (002)</p>
Current Rating (Code)	Contacts	Male Connector (M) Male Contacts (M)	Female Connector (F) Female Contacts (F)	Female Connector (F) Female Contacts (F)
25A (PWH)	05	PWH-05BMMC-LL8***	-	PWH-05BFFC-LL8***
30A (PWJ)	03	PWJ-03BMMB-LL8***	-	PWJ-03BFFB-LL8***

* Design and specification are subject to change without notice.

↘ In-line

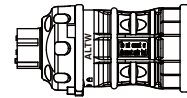
<ul style="list-style-type: none"> • Male Connector (Housing) • Female Contacts • 3 Points Lock Bayonet • Unlock Tool Needed (Part Number: ANB00010649) 		<p>Field Installable</p>  <p>***Selecting the cable OD range 12~16mm (001) or OD 09~12mm (002)</p>	<p>Overmolded with Cable</p> 	<p>Field Installable</p>  <p>***Selecting the cable OD range 12~16mm (001) or OD 09~12mm (002)</p>
Current Rating (Code)	Contacts	Male Connector (M) Female Contacts (F)	Female Connector (F) Male Contacts (M)	Female Connector (F) Male Contacts (M)
25A (PWH)	05	PWH-05BMFC-LL8***	-	PWH-05BFMC-LL8***
30A (PWJ)	03	PWJ-03BMFB-LL8***	-	PWJ-03BFMB-LL8***

↘ In-line

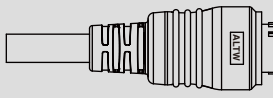
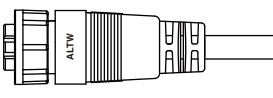
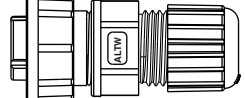
<ul style="list-style-type: none"> • Male Connector (Housing) • Male Contacts • 2 Points Lock Bayonet & 3 Points Lock Bayonet 		<p>Overmolded with Cable</p>  <p>** Selecting the proper cable length from 1~99m for your connector</p>	<p>Overmolded with Cable</p>  <p>** Selecting the proper cable length from 1~99m for your connector</p>	<p>Field Installable</p>  <p>*** Selecting UL (002) or Non-UL (001)</p>
Current Rating (Code)	Contacts	Male Connector (M) Female Contacts (F)	Female Connector (F) Male Contacts (M)	Female Connector (F) Male Contacts (M)
20A (PWC)	03	PWC-03AMFM-LL7A** PWC-03AMFM-LL7B** PWC-03AMFM-LL7D** PWC-03AMFM-LL7E** PWC-03BMFM-LL7D** PWC-03BMFM-LL7E** PWC-03AMFM-TL7A** PWC-03AMFM-TL7B**	PWC-03AFMM-LL7A** PWC-03AFMM-LL7B** PWC-03AFMM-LL7D** PWC-03AFMM-LL7E** PWC-03BFMM-LL7D** PWC-03BFMM-LL7E** PWC-03AFMM-TL7A** PWC-03AFMM-TL7B**	PWC-03BFMA-LL7***
20A+2A (PWCU)	04	PWCU-04AMFM-LL7A** PWCU-04AMFM-LL7B**	PWCU-04AFMM-LL7A** PWCU-04AFMM-LL7B**	-

Receptacle and Mating Pair

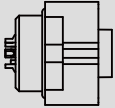
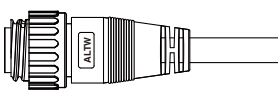
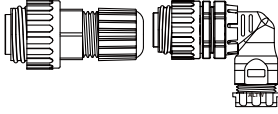
<ul style="list-style-type: none"> • Female Connector (Housing) • Female Contacts • Screw Thread 		Receptacle 	Overmolded with Cable 	Field Installable 
		*** Choose Pin Plated: Gold Plated (001) / Silver Plated (002) / Tin Plated (003)	** Choose the proper cable length from 1~99m for your connector	8 Choose straight (L) or right angle (R) *** Choose Pin Plated: Gold Plated (001) / Silver Plated (002) / Tin Plated (003)
Current Rating (Code)	Contacts 2	Female Connector (F) Female Contacts (F)	Male Connector (M) Male Contacts (M)	Male Connector (M) Male Contacts (M)
8A (PWE)	05~07	PWE-2 PFFS-SC7001	PWE-2 AMMM-SL7A**	PWE-2 BMMA-SL7001
12A (PWF)	02~04	PWF-2 PFFS-SC7001	PWF-2 AMMM-SL7A**	PWF-2 BMMA-SL7001
16A (PWG)	04	PWG-04PFFB-SC7***	-	PWG-04BMMB-S 8 7***

Receptacle and Mating Pair

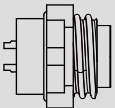
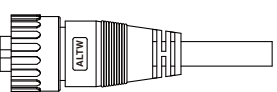
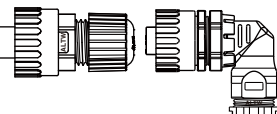
<ul style="list-style-type: none"> • Male Connector (Housing) • Male Contacts • Screw Thread 		Receptacle 	Overmolded with Cable 	Field Installable 
		*** Choose Pin Plated: Gold Plated (001) / Silver Plated (002) / Tin Plated (003)	** Choose the proper cable length from 1~99m for your connector	8 Choose straight (L) or right angle (R) *** Choose Pin Plated: Gold Plated (001) / Silver Plated (002) / Tin Plated (003)
Current Rating (Code)	Contacts 2	Male Connector (M) Male Contacts (M)	Female Connector (F) Female Contacts (F)	Female Connector (F) Female Contacts (F)
8A (PWE)	05~07	PWE-2 PMMS-SC7001	PWE-2 AFFM-SL7A**	PWE-2 BFFA-SL7001
12A (PWF)	02~04	PWF-2 PMMS-SC7001	PWF-2 AFFM-SL7A**	PWF-2 BFFA-SL7001
16A (PWG)	04	PWG-2 PMMB-SC7***	-	PWG-04BFFB-S 8 7***
25A (PWH)	03	PWH-03PMMB-SC7001	PWH-03AFFM-SL7A**	-

* Design and specification are subject to change without notice.



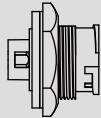
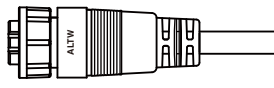
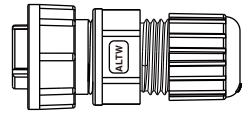

Receptacle and Mating Pair

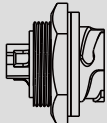
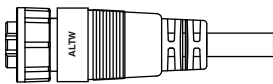
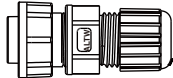
<ul style="list-style-type: none"> • Male Connector (Housing) • Male Contacts • 2 Points Lock Bayonet 		<p>Receptacle</p> 	<p>Overmolded with Cable</p> 	<p>Field Installable</p> 
			<p>** Selecting the proper cable length from 1~99m for your connector</p>	<p>*** Selecting UL (002) or Non-UL (001)</p>
Current Rating (Code)	Contacts	Male Connector (M) Male Contacts (M)	Female Connector (F) Female Contacts (F)	Female Connector (F) Female Contacts (F)
20A (PWC)	03	PWC-03PMMS-LC7001 (UL) PWC-03RMMS-LC7001 (Non UL) PWC-03RMMS-LC7002 (UL)	PWC-03AFFM-LL7A** PWC-03AFFM-LL7B** PWC-03AFFM-LL7D** PWC-03AFFM-LL7E** PWC-03BFFM-LL7D** PWC-03BFFM-LL7E**	PWC-03BFFA-LL7***
20A+2A (PWCU)	(3+1)	PWCU-04RMMS-LC7001 (Non UL) PWCU-04RMMS-LC7002 (UL)	PWCU-04AFFM-LL7A** PWCU-04AFFM-LL7B**	-

Receptacle and Mating Pair

<ul style="list-style-type: none"> • Male Connector (Housing) • Female Contacts • 3 Points Lock Bayonet 		<p>Receptacle</p> 	<p>Overmolded with Cable</p>  <p>** Cable length from 1~99m for your connector</p>	<p>Field Installable</p>  <p>***Selecting UL(002) or Non-UL (001)</p>
Current Rating (Code)	Contacts	Male Connector (M) Male Contacts (M)	Female Connector (F) Female Contacts (F)	Female Connector (F) Female Contacts (F)
20A (PWC)	03	PWC-03RMMS-TC7001	PWC-03AFFM-TL7A** PWC-03AFFM-TL7B**	-
30A (PWL)	03	PWL-03PMMB-TS7001	-	PWL-03BFFA-TL7***

Receptacle and Mating Pair



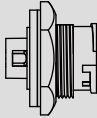
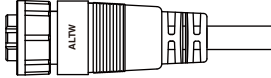
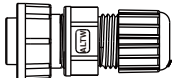

<ul style="list-style-type: none"> • Male Connector (Housing) • Female Contacts • 3 Points Lock Bayonet • PWH For Inverter Application • Unlock Tool Needed  (Part Number: ANB00010649) 		<p>Receptacle</p> 	<p>Overmolded with Cable</p>  <p>UL 6703A Certification (E-Number 346280)</p> <p>***Selecting the cable OD range 12~16mm (001) or OD 09~12mm (002)</p>	<p>Field Installable</p> 
Current Rating (Code)	Contacts	Male Connector (M) Male Contacts (M)	Female Connector (F) Female Contacts (F)	Female Connector (F) Female Contacts (F)
25A (PWH)	05	PWH-05PMMC-LC8001	-	PWH-05BFFC-LL8***
30A (PWJ)	03	PWJ-03PMMB-LC8001	-	PWJ-03BFFB-LL8***

* Design and specification are subject to change without notice.

Receptacle and Mating Pair

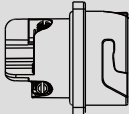
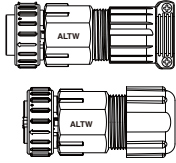
<ul style="list-style-type: none"> • Male Connector (Housing) • Female Contacts • 2 Points Lock Bayonet 		<p>Receptacle</p>  <p>***Selecting UL (002) or Non-UL (001)</p>	<p>Overmolded with Cable</p>  <p>** Cable length from 1~99m for your connector</p>	<p>Field Installable</p>  <p>***Selecting UL(002) or Non-UL (001)</p>
Current Rating (Code)	Contacts	Male Connector (M) Female Contacts (F)	Female Connector (M) Male Contacts (F)	Female Connector (M) Male Contacts (F)
20A (PWC)	03	PWC-03PMFS-LC7001 PWC-03RMFS-LC7*** PWC-03RMFS-TC7001	PWC-03AFMM-LL7A** PWC-03AFMM-LL7B** PWC-03AFMM-LL7D** PWC-03AFMM-LL7E** PWC-03AFMM-TL7A** PWC-03AFMM-TL7B**	PWC-03BFMA-LL7***
20A+2A (PWCU)	(3+1)	PWCU-04RMFS-LC7***	PWCU-04AFMM-LL7A** PWCU-04AFMM-LL7B**	PWCU-04BFMA-LL7002

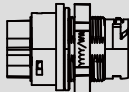
Receptacle and Mating Pair

<ul style="list-style-type: none"> • Male Connector (Housing) • Female Contacts • 3 Points Lock Bayonet 		<p>Receptacle</p> 	<p>Overmolded with Cable</p>	<p>Field Installable</p>  <p>***Selecting UL(002) or Non-UL (001)</p>
Current Rating (Code)	Contacts	Male Connector (M) Female Contacts (F)	Female Connector (F) Male Contacts (M)	Female Connector (F) Male Contacts (M)
20A (PWC)	03	PWC-03RMFS-TC7001	-	PWC-03BFMA-TL7001
30A (PWL)	03	PWL-03PMFB-TS7001	-	PWL-03BFMA-TL7***
<ul style="list-style-type: none"> • Male Connector (Housing) • Female Contacts • 3 Points Lock Bayonet • PWJ & PWH For Inverter Application • Unlock Tool Needed  (Part Number: ANB00010649) 		<p>Receptacle</p> 	<p>Overmolded with Cable</p>	<p>Field Installable</p>  <p>UL 6703A Certification (E-Number 346280) ***Selecting the cable OD range 12~16mm (001) or OD 09~12mm (002)</p>
Current Rating (Code)	Contacts	Male Connector (M) Female Contacts (F)	Female Connector (F) Male Contacts (M)	Female Connector (F) Male Contacts (M)
25A (PWH)	05	PWH-05PMFC-LC8001	-	PWH-05BFMC-LL8***
30A (PWJ)	03	PWJ-03PMFB-LC8001	-	PWJ-03BFMB-LL8***

M Series Sensor Connector



Range Overview

Receptacle to Overmolded with Cable

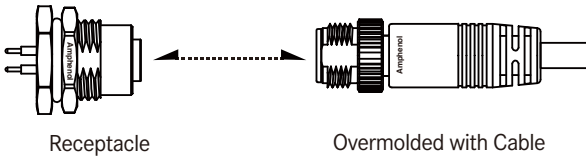

Receptacle

Overmolded with Cable

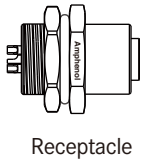

Receptacle

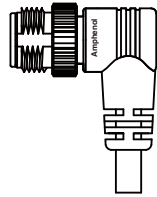

Overmolded with Cable

Receptacle to Field Installable

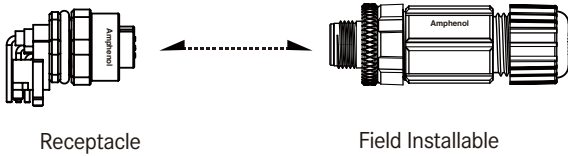

Receptacle

Field Installable

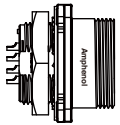

Receptacle

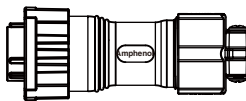

Field Installable

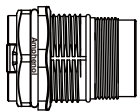

Receptacle



Field Installable

In Line

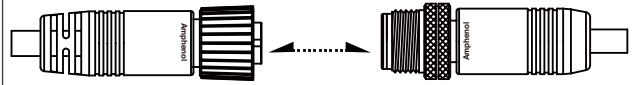

Overmolded with Cable

Overmolded with Cable

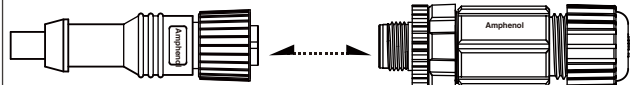

Overmolded with Cable

Field Installable

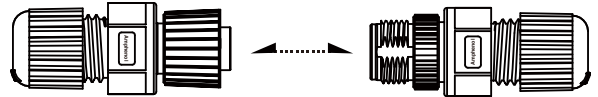

Field Installable

Field Installable

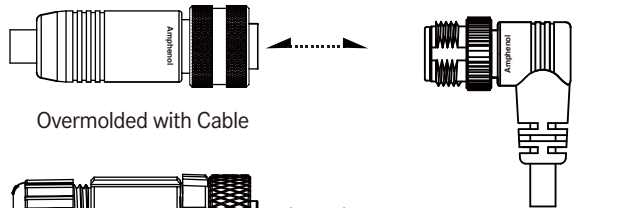

Overmolded with Cable

Overmolded with Cable

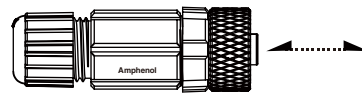

Field Installable

Others

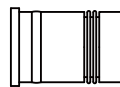

Insert

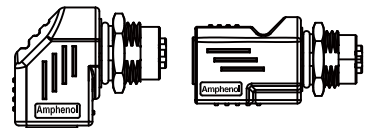

M12 to RJ45 Adaptor

Accessories

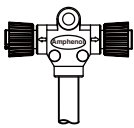

T Cable
See page 21-2



Y Cable
See page 21-3

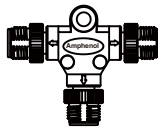

T Adaptor
See page 21-5



Y Adaptor
See page 21-6

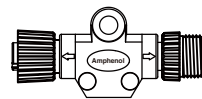

I Adaptor
See page 21-8



Waterproof Cap
See page 21-14

Specification

Identifications	M8, M10.5, M12 (A, B, D code), Heavy Duty Shielded Connector, M23
Description	Receptacle Overmolded with Cable Field Installable
Current Rating / Data	1.5A~28A
Material	Contacts: Copper Alloy, Gold Plated Connector Body (Housing) : Nylon+GF or PU, UL Recognized Metal Screw Nut: Zinc Alloy or Copper Ally, Nickel Plated
Waterproof Rating	IP65, IP67~68
Temperature Range	Receptacle: -40°C~105°C Overmolded with Cable: PVC Cable: -20°C~80°C PU Cable: -20°C~85°C Field Installable: -40°C~105°C * Higher working temperature upon request.
Contact Resistance	≤ 10mΩ
Standard Cable Length	01~99M
Mating Cycle	100* Minimum
Vibration	10 ~ 500 Hz and 0.35 mm
Standards	IEC 61076-2-101 IEC 61076-2-104

* Design and specification are subject to change without notice.

Ordering Information

	1	2	3	4	5	6	7	8	9	10	
Specification / Size											
<u>>M8 Size</u>											
(8) M8	<u>>Heavy Duty Shielded Connector,</u>										
(8P) M8 (Plastic)	(HB20)	Metal, Salt Spray Test 500H, 10A									
(8A) M8 W/ KEY	(LB20)	Metal, Salt Spray Test 48H, 10A									
(8AP) M8 W/ KEY (Plastic)	(HC20)	Metal, Salt Spray Test 500H, 20A									
<u>>M10.5 Size</u>											
(105) M10.5	(LC20)	Metal, Salt Spray Test 48H, 20A									
<u>>M12 Size:</u>											
(12) M12 A-Coded	(HD20)	Metal, Salt Spray Test 500H, 5A									
(12L) M12 A-Coded inserted with LED	(LD20)	Metal, Salt Spray Test 48H, 5A									
(12P) M12 A-Coded (Plastic)	<u>>M23 Size</u>										
(12S) M12 A-Coded (Shielded)	(LJ23)	Metal, Salt Spray Test 48H, 28A									
(12B) M12 B-Coded											
(SBP) M12 B-Coded (Plastic)											
(SBS) M12 B-Coded (Shielded)											
(12D) M12 D-Coded											
(SDP) M12 D-Coded (Plastic)											
(SDS) M12 D-Coded (Shielded)											
Number of Contacts											
02, 03.....,14...Contacts											
EX. (02) = 2 Contacts											
Connector Body (Style)											
<u>> For Receptacle</u>											
(P) Panel	<u>> For Overmolded with Cable</u>				<u>> For Field installable</u>						
	(A) With Strain Relief				(B) Without Strain Relief						
	(B) Without Strain Relief				(D) With Ground Pin						
Connector (Housing) Gender											
(M) Male Connector	(F) Female Connector										
Contact Gender											
(M) Male	(I) I style (Male+Female)										
(F) Female											
Assemble Style											
<u>> For Receptacle</u>											
(S) Solder Type	<u>> For Field Installable</u>				<u>> For Overmolded with Cable</u>						
(P) 180° PCB Type	(A) Field installable(Solder)				(M) Overmolded with Cable						
(R) 90° PCB Type	(B) Field installable(Screw)										
(C) Crimp Type	(C) Field installable(Crimp)										
	(D) Field Installable (IDC)										
Mating Style											
(S) Screw Thread	(Q) Quick										
Backshell											
<u>> For Receptacle</u>											
(C) Circular (Rear Fastened)	<u>> For Receptacle</u>				<u>> For Overmolded with Cable</u>			<u>> For Field Installable</u>			
(F) Hexagonal Front Fastened	(W) Square Front Fastened with Screw				(L) Straight			(L) Straight			
(H) Rear Hexagonal (Rear Fastened)	(N) Square Rear Fastened with Nut				(R) Right Angle			(R) Right Angle			
Waterproof Rating											
(5) IP65 (Quick Type)	(8) IP 68										
(7) IP 67											
Cable information											
<u>> For Receptacle</u>											
(001) / (002) : PG9	<u>> For Overmolded with Cable</u>				<u>> For Receptacle with wire harness</u>						
(003) / (004) / (005) : M16	(□)+(■) : Cable Type + Cable Length				(□)+(■) : Cable Type + Wire Length						
(006) : M12	EX. (A01) = UL2464 Cable + 1M				EX. (A15) = UL 1007 (For M8) + 150mm						
	(□) : Cable Type (■) : Cable Length				(□) Cable Type						
	(A) PVC UL2464 Cable From 1M to 99M				(A) UL 1007 (For M8)						
	EX.(01)= 1M				(B) UL1061 (For M12-PG9 W/ O Logo)						
					(C) UL1061 (For M12-M16 W / O Logo)						
					(■) Wire length						
					(15) 150mm						
					(30) 300mm						
					(50) 500mm						

* UL2517 / UL20549 available by 2014

Physical Dimension

Receptacle

Panel Cut-Out

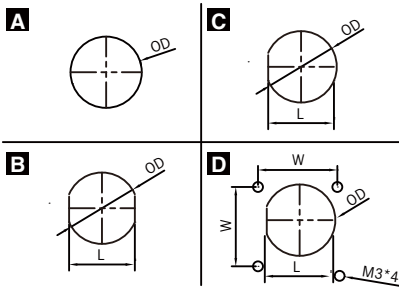

Size		Dimension			Type	L / W	OD
Size	Thread Description	Female			Male		
M105	M10.5 X 0.75	-	-	-	A	-	10.9
M8	M8 X 1.0	B	7.1	8.1	B	7.1	8.1
		-	-	-	A	-	8.1
M12	M12 X 1.0 - PG9	B	13.6	15.4	B	13.6	15.4
	M12 X 1.0 - M16.0 X 1.5	B	13.6	16.1	B	13.6	16.1
	M12.0 X 1.0	B	10.5	12.2	B	10.5	12.2
HDSC*	M22 X 1.0	-	-	-	C	19.2	20.2
		-	-	-	D	19.2 / 23.0	20.2
M23	M23 X 1.0	-	-	-	C	24.4	25.1

*HDSC: Heavy Duty Shielded Connector

Connector Dimension

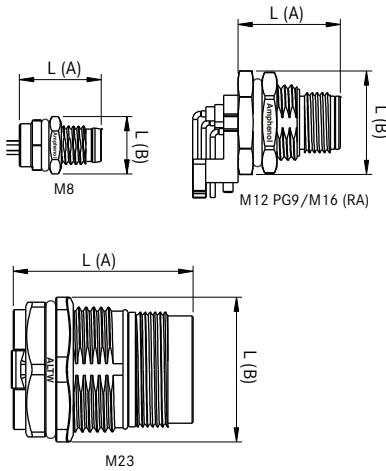

Series	Conn. Gender	Receptacle				Panel Thickness		
		Female		Male		Front Fastened	Rear Fastened	
Type	L (A)	L (B)	L (A)	L (B)				
M8	Straight	18.0	13.8	16.4	11.5	3.0 mm Max.	3.5 mm Max.	
M105	Straight	-	-	18.0	15.0	-	6.0 mm Max.	
M12	PG9/ M16	Straight	20.0	20.8	20.5	20.8	4.5mm Max. 4.0mm Max.(Plastic)	4.5mm Max.
		Right Angle	20.0	20.8	20.5	20.8		
	M12 * 1.0	Right Angle	16.9	15.0	16.2	15.0	3.0mm Max.	
HDSC*	Straight	-	-	23.5	29.0	9.0mm Min.	5.0 mm Max.	
M23	Straight	-	-	36.0	29.0	6.0 mm Max.	-	

*HDSC: Heavy Duty Shielded Connector

Overmolded with Cable

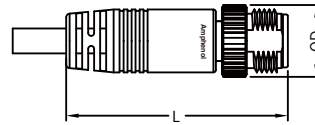
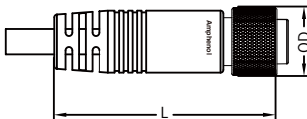

Size		Dimension	
Size	Thread Description	L	OD
Female			
M105	M10.5 X 0.75	36.5	8.4

Size		Dimension			
Size	Thread Description	L		OD	
M105	M10.5 X 0.75	Female	Male	Female	Male
M8	M8 X 1.0	38.1	42.7	10.1	10.5
M12	M12.0 X 1.0	43.3	44.4	14.5	14.4

Dimensions are shown in millimeters

M Series Sensor Connector | Physical Dimension

Receptacle | Overmolded with Cable | Field Installable

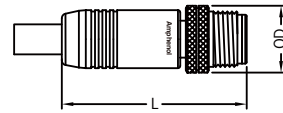
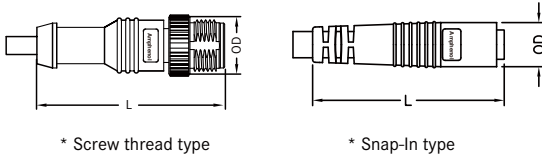

Size		Dimension		L		OD	
Size	Type	Female	Male	Female	Male	Female	Male
M8	Screw Thread M8 X 1.0	36.0	40.5	10.1	10.5		
M8	Snap-In M8 X 1.0	36.5	-	8.4	-		
M105	Screw Thread M10.5 X 0.75	37.2	-	12.0	-		
M12	Screw Thread M12.0 X 1.0	43.3	44.4	14.5	14.4		

Size		Dimension		L		OD	
Size	Thread Description	Female	Male	Female	Male	Female	Male
M12	M12.0 X 1.0	39.2	40.1	14.5	14.5		

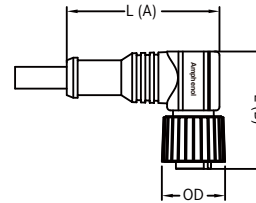
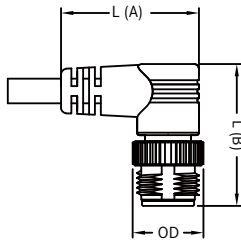

Size		Dimension		L [A]		L [B]		OD	
Size	Thread Description	Female	Male	Female	Male	Female	Male	Female	Male
M105	M10.5 X 0.75	24.0	-	24.0	-	12.0	-		
M8	M8 X 1.0	20.7	20.7	20.0	25.5	10.1	10.5		
M12	M12.0 X 1.0	28.0	28.0	27.9	28.9	14.5	14.4		

Size		Dimension		L [A]		L [B]		OD	
Size	Thread Description	Female	Male	Female	Male	Female	Male	Female	Male
M105	M10.5 X 0.75	19.0	-	24.0	-	12.0	-		
M8	M8 X 1.0	25.0	25.0	21.0	25.6	10.1	10.5		
M12	M12.0 X 1.0	35.0	35.0	26.9	27.9	14.5	14.4		

Field Installable

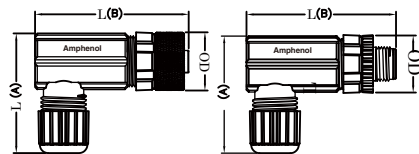
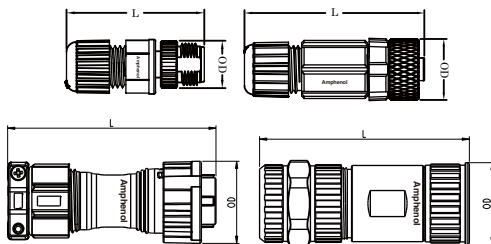

Size		Dimension		L		OD	
Size	Type	Pin Type	Female	Male	Female	Male	Male
M8	M8 X 1.0	Screw In	55.4	59.1	16.7	16.7	
M12	M12.0 X 1.0	Solder	40.5	41.8	14.5	14.4	
		Screw In	61.3	61.3	20.8	20.8	
M12 Plastic	M12.0 X 1.0	Solder	40.5	41.8	14.8	13.8	
		Screw In	61.3	61.3	20.8	20.4	
HDSC*	M22 X 1.0	-	72.5	-	27.7	-	
M23	M23 X 1.0	-	73.0	-	28.5	-	

Size		Dimension		L [A]		L [B]		OD	
Size	Thread Description	Pin Type	Female	Male	Female	Male	Female	Male	Male
M12	M12.0 X 1.0	Screw In	38.9	38.9	52.3	52.3	20.8	20.8	
M12 Plastic			38.9	38.9	52.3	52.3	20.8	20.8	

Dimensions are shown in millimeters

*HDSC: Heavy Duty Shielded Connector

* Design and specification are subject to change without notice.

Contact Configuration

	M8			M105 (2A)	M12 A Code (3~5P: 4A 8P: 2A)	M12 B Code (4A)	M12 D Code (4A)	M12 I Style (4A)				
	(1.5A)	(3A)		(2A)	(3~5P: 4A 8P: 2A)	(4A)	(4A)	(4A)				
④ ⑤	MM or FF	MM or FF	MM or FF	MF or FM	MM or FF	MF or FM	MM or FF	MF or FM	MM or FF	MF or FM	MME or FFM	MF or FM
2Pin (02)												
		R C F		R C								
3Pin (03)												
		R C F	R C F	R C	R C F		R F		R F			
4Pin (04)												
		R C F	R C F	R C	R C F		R C F		R C F			
5Pin (05)												
	R C F			R C	R C F		R C F		R C F		R C F	
6Pin (06)												
	R C F											
7Pin (07)												
8Pin (08)												
					R C F							
10Pin (10)												
12Pin (12)												
14Pin (14)												

More to know:

No. of Poles & Contact Configuration (Connection side view)

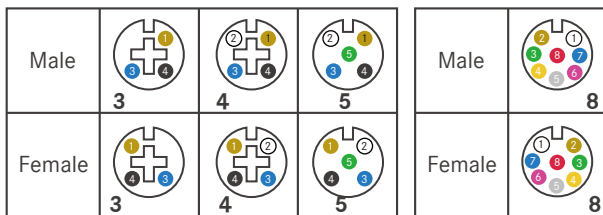

Color Identification:
1 = Brown, 2 = White, 3 = Blue, 4 = Black, 5 = Green

Color Identification:
1 = White, 2 = Brown, 3 = Green, 4 = Yellow,
5 = Gray, 6 = Pink, 7 = Blue, 8 = Red

HDSC* (5A)		HDSC* (10A)		HDSC* (20A)		M23 (28A)	
MM or FF	MF or FM	MM or FF	MF or FM	MM or FF	MF or FM	MM or FF	MF or FM
					R F		
					R F		
			R F				
			R F				
						R F	R F
			R F				
	R F						
	R F						
	R F						

*HDSC: Heavy Duty Shielded Connector

M12 Panel Version	Screw Thread Size	Logo
001	M12XPG9	With Logo
002	M12XPG9	Without Logo
003	M12XM16.0X1.5	With Logo
004	M12XM16.0X1.5	Without Logo
005	M12XM16.0X1.5	Without Logo
006	M12X1.0	With Logo
007	M12X1.0	Without Logo

* Design and specification are subject to change without notice.

R: receptacle
C: overmolded with cable
F: field installable

- 1**
- 1.5A (M8)
 - 2A (M105/M12 A)
 - 3A (M8)
 - 4A (M12 A/M12 B/M12 D/M12 I Style)
 - 5A (HDSC*)
 - 10A (HDSC*)
 - 20A (HDSC*)
 - 28A (M23)

2

Contact Number:
 Ex.2 contacts (02)

4

Connector (Housing) Gender:
 Male(M) or Female(F)



5

Contact Gender:
 Male(M) or Female(F)
 Male + Female (I)

6





More to Choose:

- Solder (S)
 - Solder Cup
- PCB Type
 - 90° PCB (R) - 180° PCB (P)

More to know:

A-Code B-Code D-Code I-Style

Product Features

Receptacle

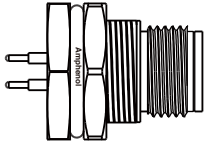

Mating Style 7



Screw Thread (S)

Backshell 8



Circular (C)



Hexagonal (H)(F)



Square (N)(W)

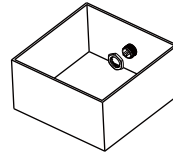

Rear Fastened

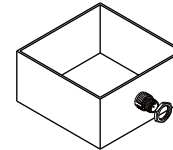

Front Fastened (P)

Overmolded with Cable

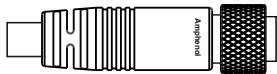

Mating Style 7



Screw Thread (S)
(For M12)



Quick (Q)
(For M8)

Backshell 8

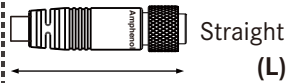

Straight (L)

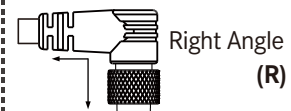

Right Angle (R)

Connector Body (Style) 3



With Strain Relief (A)

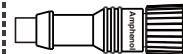

Without Strain Relief (B)

Field Installable

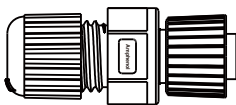

Mating Style 7



Screw Thread (S)

Backshell 8

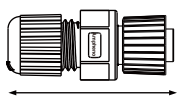

Straight (L)

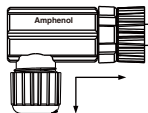

Right Angle (R)



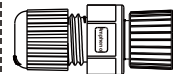





Connector Body (Style) 3

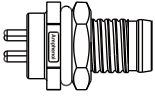

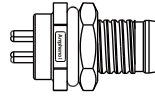





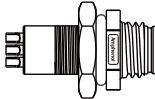

Without Strain Relief (B)

Find Our Standard Products

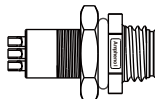
∟ M8 (Metal) > Receptacle > Male Connector > Front Fastened

> IEC 61076-2-104						
						
Backshell: Hexagonal						
Type	2 Contacts	3 Contacts	4 Contacts	5 Contacts	6 Contacts	
PCB Pin	-	8-03PMMP-SF7001	8-04PMMP-SF7001	-	-	
Solder Pin	-	8-03PMMS-SF7001	8-04PMMS-SF7001	-	-	
Wire Leads (150mm)	-	8-03PMMS-SF715	8-04PMMS-SF715	-	-	
Wire Leads (300mm)	-	8-03PMMS-SF730	8-04PMMS-SF730	-	-	
Wire Leads (500mm)	-	8-03PMMS-SF750	8-04PMMS-SF750	-	-	
> with alignment Key						
						
Backshell: Hexagonal						
Type	2 Contacts	3 Contacts	4 Contacts	5 Contacts	6 Contacts	
PCB Pin	8A-02PMMP-SF7001	8A-03PMMP-SF7001	8A-04PMMP-SF7001	8A-05PMMP-SF7001	8A-06PMMP-SF7001	
Solder Pin	8A-02PMMS-SF7001	8A-03PMMS-SF7001	8A-04PMMS-SF7001	8A-05PMMS-SF7001	8A-06PMMS-SF7001	

∟ M8 (Metal) > Receptacle > Male Connector > Rear Fastened

> IEC 61076-2-104						
						
Backshell: Hexagonal						
Type	2 Contacts	3 Contacts	4 Contacts	5 Contacts	6 Contacts	
PCB Pin	-	8-03PMMP-SH7001	8-04PMMP-SH7001	-	-	
Solder Pin	-	8-03PMMS-SH7001	8-04PMMS-SH7001	-	-	
Wire Leads (150mm)	-	8-03PMMS-SH715	8-04PMMS-SH715	-	-	
Wire Leads (300mm)	-	8-03PMMS-SH730	8-04PMMS-SH730	-	-	
Wire Leads (500mm)	-	8-03PMMS-SH750	8-04PMMS-SH750	-	-	
> with alignment Key						
						
Backshell: Hexagonal						
Type	2 Contacts	3 Contacts	4 Contacts	5 Contacts	6 Contacts	
Solder Pin	8A-02PMMS-SH7001	8A-03PMMS-SH7001	8A-04PMMS-SH7001	8A-05PMMS-SH7002	8A-06PMMS-SH7002	

* Design and specification are subject to change without notice.

M8 (Metal)







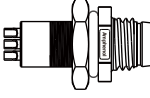
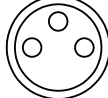

Receptacle > Female Connector

Overmolded with Cable > Male Connector

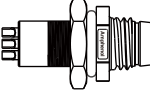





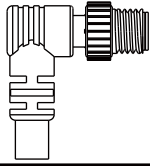
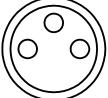

IP 65 . 67 

Receptacle | Unmated
Overmolded with Cable | Mated
Field Installable | Mated

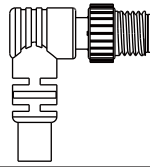
∟ M8 (Metal) Receptacle > Female Connector > Rear Fastened







> IEC 61076-2-104						
						
Backshell: Hexagonal						
Type	2 Contacts	3 Contacts	4 Contacts	5 Contacts	6 Contacts	
Solder Pin	-	8-03PFFS-SH7001	8-04PFFS-SH7001	-	-	
Wire Leads (150mm)	-	8-03PFFS-SH715	8-04PFFS-SH715	-	-	
Wire Leads (300mm)	-	8-03PFFS-SH730	8-04PFFS-SH730	-	-	
Wire Leads (500mm)	-	8-03PFFS-SH750	8-04PFFS-SH750	-	-	
> with alignment Key						
						
Backshell: Hexagonal						
Type	2 Contacts	3 Contacts	4 Contacts	5 Contacts	6 Contacts	
Solder Pin	8A-02PFFS-SH7001	8A-03PFFS-SH7001	8A-04PFFS-SH7001	8A-05PFFS-SH7002	8A-06PFFS-SH7002	

∟ M8 (Metal) > Overmolded with cable > Male Connector > Right Angle

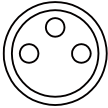
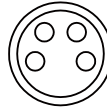





> IEC 61076-2-104						
						
Type	2 Contacts	3 Contacts	4 Contacts	5 Contacts	6 Contacts	
With Strain Relief	-	8-03AMMM-SR7	8-04AMMM-SR7	-	-	
Without Strain Relief	-	8-03BMMM-SR7	8-04BMMM-SR7	-	-	
> with alignment Key						
						
Type	2 Contacts	3 Contacts	4 Contacts	5 Contacts	6 Contacts	
With Strain Relief	8A-02AMMM-SR7	8A-03AMMM-SR7	8A-04AMMM-SR7	8A-05AMMM-SR7	8A-06AMMM-SR7	

Cable Type	1M	3M	5M	10M
PVC	A01	A02	A05	A10
PU	B01	B02	B05	B10

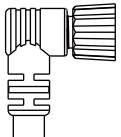
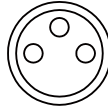
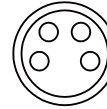
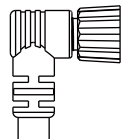
➤ **M8 (Metal) > Overmolded with cable > Male Connector > Straight**

➤ IEC 61076-2-104					
					
Type	2 Contacts	3 Contacts	4 Contacts	5 Contacts	6 Contacts
With Strain Relief	-	8-03AMMM-SL7	8-04AMMM-SL7	-	-
Without Strain Relief	-	8-03BMMM-SL7	8-04BMMM-SL7	-	-
➤ with alignment Key					
					
Type	2 Contacts	3 Contacts	4 Contacts	5 Contacts	6 Contacts
With Strain Relief	8A-02AMMM-SL7	8A-03AMMM-SL7	8A-04AMMM-SL7	8A-05AMMM-SL7	8A-06AMMM-SL7

➤ **M8 (Metal) > Overmolded with cable > Female Connector > Right Angle**

➤ IEC 61076-2-104					
					
Type	2 Contacts	3 Contacts	4 Contacts	5 Contacts	6 Contacts
With Strain Relief	-	8-03AFFM-SR7	8-04AFFM-SR7	-	-
Without Strain Relief	-	8-03BFFM-SR7	8-04BFFM-SR7	-	-
➤ with alignment Key					
					
Type	2 Contacts	3 Contacts	4 Contacts	5 Contacts	6 Contacts
With Strain Relief	8A-02AFFM-SR7	8A-03AFFM-SR7	8A-04AFFM-SR7	8A-05AFFM-SR7	8A-06AFFM-SR7

Cable Type	1M	3M	5M	10M
PVC	A01	A02	A05	A10
PU	B01	B02	B05	B10

* Design and specification are subject to change without notice.







M8 (Metal)

Overmolded with Cable > Female Connector

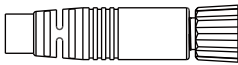
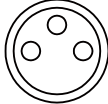
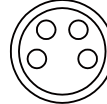
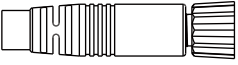
IP 67 . 68 







Receptacle | Unmated
Overmolded with Cable | Mated
Field Installable | Mated

∨ **M8 (Metal) > Overmolded with cable > Female Connector > Straight**

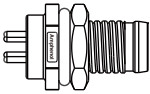
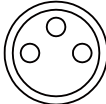
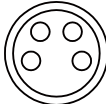
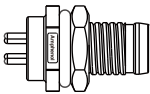





> IEC 61076-2-104					
					
Type	2 Contacts	3 Contacts	4 Contacts	5 Contacts	6 Contacts
With Strain Relief	-	8-03AFFM-SL7	8-04AFFM-SL7	-	-
Without Strain Relief	-	8-03BFFM-SL7	8-04BFFM-SL7	-	-
> with alignment Key					
					
Type	2 Contacts	3 Contacts	4 Contacts	5 Contacts	6 Contacts
With Strain Relief	8A-02AFFM-SL7	8A-03AFFM-SL7	8A-04AFFM-SL7	8A-05AFFM-SL7	8A-06AFFM-SL7

Cable Type	1M	3M	5M	10M
PVC	A01	A02	A05	A10
PU	B01	B02	B05	B10

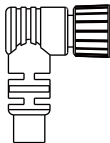
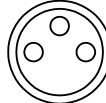
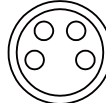
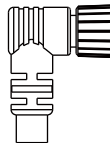
∟ **M8 (Plastic) > Receptacle > Male Connector > Front Fastened**

> IEC 61076-2-104					
					
Backshell: Hexagonal					
Type	2 Contacts	3 Contacts	4 Contacts	5 Contacts	6 Contacts
PCB Pin	-	8P-03PMMP-SF7001	8P-04PMMP-SF7001	-	-
Solder Pin	-	8P-03PMMS-SF7001	8P-04PMMS-SF7001	-	-
> with alignment Key					
					
Backshell: Hexagonal					
Type	2 Contacts	3 Contacts	4 Contacts	5 Contacts	6 Contacts
PCB Pin	8AP-02PMMP-SF7001	8AP-03PMMP-SF7001	8AP-04PMMP-SF7001	8AP-05PMMP-SF7001	8AP-06PMMP-SF7001
Solder Pin	8AP-02PMMS-SF7001	8AP-03PMMS-SF7001	8AP-04PMMS-SF7001	8AP-05PMMS-SF7001	8AP-06PMMS-SF7001

∟ **M8 (Plastic) > Overmolded with cable > Male Connector > Right Angle**

> IEC 61076-2-104					
					
Type	2 Contacts	3 Contacts	4 Contacts	5 Contacts	6 Contacts
With Strain Relief	-	8P-03AMMM-SR7	8P-04AMMM-SR7	-	-
Without Strain Relief	-	8P-03BMMM-SR7	8P-04BMMM-SR7	-	-
> with alignment Key					
					
Type	2 Contacts	3 Contacts	4 Contacts	5 Contacts	6 Contacts
With Strain Relief	8AP-02AMMM-SR7	8AP-03AMMM-SR7	8AP-04AMMM-SR7	8AP-05AMMM-SR7	8AP-06AMMM-SR7

Cable Type	1M	3M	5M	10M
PVC	A01	A02	A05	A10
PU	B01	B02	B05	B10

* Design and specification are subject to change without notice.







M8 (Plastic)

Overmolded with Cable > Male / Female Connector

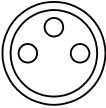
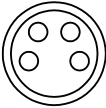





IP 67 . 68 9

Receptacle | Unmated
Overmolded with Cable | Mated
Field Installable | Mated

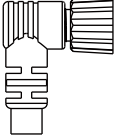
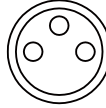
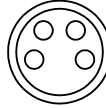
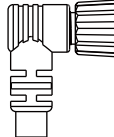
➤ **M8 (Plastic) > Overmolded with cable > Male Connector > Straight**

> IEC 61076-2-104					
					
Type	2 Contacts	3 Contacts	4 Contacts	5 Contacts	6 Contacts
With Strain Relief	-	8P-03AMMM-SL7	8P-04AMMM-SL7	-	-
Without Strain Relief	-	8P-03BMMM-SL7	8P-04BMMM-SL7	-	-
> with alignment Key					
					
Type	2 Contacts	3 Contacts	4 Contacts	5 Contacts	6 Contacts
With Strain Relief	8AP-02AMMM-SL7	8AP-03AMMM-SL7	8AP-04AMMM-SL7	8AP-05AMMM-SL7	8AP-06AMMM-SL7





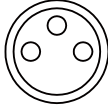
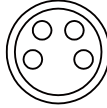

➤ **M8 (Plastic) > Overmolded with cable > Female Connector > Right Angle**

> IEC 61076-2-104					
					
Type	2 Contacts	3 Contacts	4 Contacts	5 Contacts	6 Contacts
With Strain Relief	-	8P-03AFFM-SR7	8P-04AFFM-SR7	-	-
Without Strain Relief	-	8P-03BFFM-SR7	8P-04BFFM-SR7	-	-
> with alignment Key					
					
Type	2 Contacts	3 Contacts	4 Contacts	5 Contacts	6 Contacts
With Strain Relief	8AP-02AFFM-SR7	8AP-03AFFM-SR7	8AP-04AFFM-SR7	8AP-05AFFM-SR7	8AP-06AFFM-SR7

Cable Type	1M	3M	5M	10M
PVC	A01	A02	A05	A10
PU	B01	B02	B05	B10

∟ **M8 (Plastic) > Overmolded with cable > Female Connector > Straight**

> IEC 61076-2-104					
					
Type	2 Contacts	3 Contacts	4 Contacts	5 Contacts	6 Contacts
With Strain Relief	-	8P-03AFFM-SL7	8P-04AFFM-SL7	-	-
Without Strain Relief	-	8P-03BFFM-SL7	8P-04BFFM-SL7	-	-
* Mating style (Quick) also available for 3 & 4 contacts					

> with alignment Key						
						
Type	2 Contacts	3 Contacts	4 Contacts	5 Contacts	6 Contacts	
With Strain Relief	8AP-02AFFM-SL7	8AP-03AFFM-SL7	8AP-04AFFM-SL7	8AP-05AFFM-SL7	8AP-06AFFM-SL7	

Cable Type	1M	3M	5M	10M
PVC	A01	A02	A05	A10
PU	B01	B02	B05	B10

* Mating style (Quick) also available for 3 & 4 contacts

∟ **M8 (Plastic) > Field Installable > Male Connector > Straight**

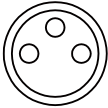
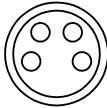
					
Type	Contact Type	3 Contacts	4 Contacts	5 Contacts	6 Contacts
Without Strain Relief	Solder	-	-	-	-
	Screw-in	8P-03BMMB-SL7001	8P-04BMMB-SL7001		

∟ **M8 (Plastic) > Field Installable > Female Connector > Straight**

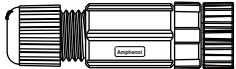
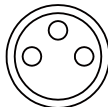
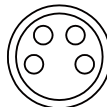
					
Type	Contact Type	3 Contacts	4 Contacts	5 Contacts	6 Contacts
Without Strain Relief	Solder	-	-	-	-
	Screw-in	-	8P-04BFFB-SL7001	-	-

* Design and specification are subject to change without notice.

M10.5 (Metal)

Receptacle > Male Connector



Overmolded with Cable > Male Connector

Receptacle | Unmated
Overmolded with Cable | Mated
Field Installable | Mated

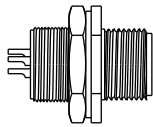
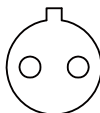
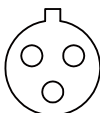
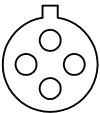
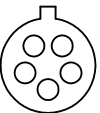

∟ **M10.5 (Metal) > Receptacle > Male Connector > Rear Fastened**

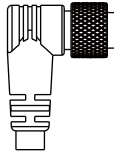
				
Backshell: Hexagonal Backshell: Circular				
Type	2 Contacts	3 Contacts	4 Contacts	5 Contacts
Backshell: Hexagonal Solder Pin (180°)	105-02PMFS-SH7001	105-03PMFS-SH7001	105-04PMFS-SH7001	105-05PMFS-SH7001
Backshell: Circular Solder Pin (180°)	105-02PMFS-SC7001	105-03PMFS-SC7001	105-04PMFS-SC7001	105-05PMFS-SC7001

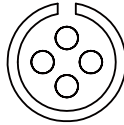
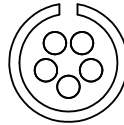
∟ **M10.5 (Metal) > Overmolded with cable > Male Connector > Right Angle**

				
Type	2 Contacts	3 Contacts	4 Contacts	5 Contacts
With Strain Relief	105-02AMMM-SR7A	105-03AMMM-SR7A	105-04AMMM-SR7A	105-05AMMM-SR7A
Without Strain Relief	105-02BFMM-SR7A	105-03BFMM-SR7A	105-04BFMM-SR7A	105-05BFMM-SR7A

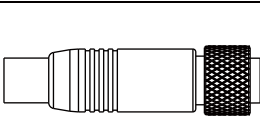
∟ **M10.5 (Metal) > Overmolded with cable > Male Connector > Straight**

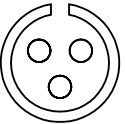
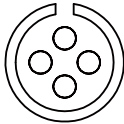
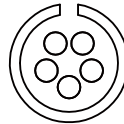
				
Type	2 Contacts	3 Contacts	4 Contacts	5 Contacts
With Strain Relief	105-02AFMM-SL7A	105-03AFMM-SL7A	105-04AFMM-SL7A	105-05AFMM-SL7A
Without Strain Relief	105-02BFMM-SL7A	105-03BFMM-SL7A	105-04BFMM-SL7A	105-05BFMM-SL7A

Cable Type	1M	3M	5M	10M
PVC	A01	A02	A05	A10
PU	B01	B02	B05	B10

∨ M12 A (Metal) > Receptacle > Male Connector > Front Fastened

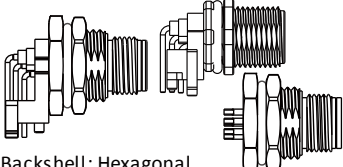
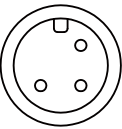
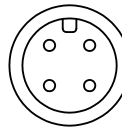
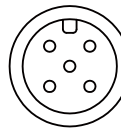
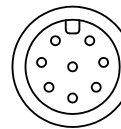
 <p>Backshell: Hexagonal</p>					
Type	Mounting Thread	3 Contacts	4 Contacts	5 Contacts	8 Contacts
PCB Pin (180°)	PG9	12-03PMMP-SF8001	12-04PMMP-SF8001	12-05PMMP-SF8001	12-08PMMP-SF8001
	M16.0	12-03PMMP-SF8003 12-03PMMP-SF8004	12-04PMMP-SF8003 12-04PMMP-SF8004	12-05PMMP-SF8003 12-05PMMP-SF8004	12-08PMMP-SF8003 12-08PMMP-SF8004
PCB Pin (90°)	M12	12-03PMMR-SF7001	12-04PMMR-SF7001	12-05PMMR-SF7001	12-08PMMR-SF7001
	M12 (Shielded)	12S-03PMMR-SF7001	12S-04PMMR-SF7001	12S-05PMMR-SF7001	12S-08PMMR-SF7001
	PG9	12-03PMMR-SF8001	12-04PMMR-SF8001	12-05PMMR-SF8001	-
	M16.0	12-03PMMR-SF8003	12-04PMMR-SF8003	12-05PMMR-SF8003	-
Solder Pin (180°)	PG9	12-03PMMS-SF8001	12-04PMMS-SF8001	12-05PMMS-SF8001	12-08PMMS-SF8001
	M16.0	12-03PMMS-SF8003 12-03PMMS-SF8004	12-04PMMS-SF8003 12-04PMMS-SF8004	12-05PMMS-SF8003 12-05PMMS-SF8004	12-08PMMS-SF8003 12-08PMMS-SF8004
Wire Leads (150mm)	PG9	12-03PMMS-SF8B15	12-04PMMS-SF8B15	12-05PMMS-SF8B15	12-08PMMS-SF8B15
	M16.0	12-03PMMS-SF8C15	12-04PMMS-SF8C15	12-05PMMS-SF8C15	12-08PMMS-SF8C15
Wire Leads (300mm)	PG9	12-03PMMS-SF8B30	12-04PMMS-SF8B30	12-05PMMS-SF8B30	12-08PMMS-SF8B30
	M16.0	12-03PMMS-SF8C30	12-04PMMS-SF8C30	12-05PMMS-SF8C30	12-08PMMS-SF8C30
Wire Leads (500mm)	PG9	12-03PMMS-SF8B50	12-04PMMS-SF8B50	12-05PMMS-SF8B50	12-08PMMS-SF8B50
	M16.0	12-03PMMS-SF8C50	12-04PMMS-SF8C50	12-05PMMS-SF8C50	12-08PMMS-SF8C50

∨ M12 A (Metal) > Receptacle > Male Connector > Rear Fastened

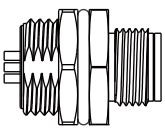
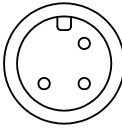
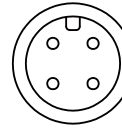
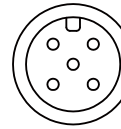
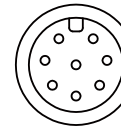
					
Type	Mounting Thread	3 Contacts	4 Contacts	5 Contacts	8 Contacts
Solder Pin (180°)	PG9	12-03PMMS-SH8001	12-04PMMS-SH8001	12-05PMMS-SH8001	12-08PMMS-SH8001
	M16.0	12-03PMMS-SH8003 12-03PMMS-SH8004	12-04PMMS-SH8003 12-04PMMS-SH8004	12-05PMMS-SH8003 12-05PMMS-SH8004	12-08PMMS-SH8003 12-08PMMS-SH8004
Wire Leads (150mm)	PG9	12-03PMMS-SH8B15	12-04PMMS-SH8B15	12-05PMMS-SH8B15	12-08PMMS-SH8B15
	M16.0	12-03PMMS-SH8C15	12-04PMMS-SH8C15	12-05PMMS-SH8C15	12-08PMMS-SH8C15
Wire Leads (300mm)	PG9	12-03PMMS-SH8B30	12-04PMMS-SH8B30	12-05PMMS-SH8B30	12-08PMMS-SH8B30
	M16.0	12-03PMMS-SH8C30	12-04PMMS-SH8C30	12-05PMMS-SH8C30	12-08PMMS-SH8C30
Wire Leads (500mm)	PG9	12-03PMMS-SH8B50	12-04PMMS-SH8B50	12-05PMMS-SH8B50	12-08PMMS-SH8B50
	M16.0	12-03PMMS-SH8C50	12-04PMMS-SH8C50	12-05PMMS-SH8C50	12-08PMMS-SH8C50

* Design and specification are subject to change without notice.

∟ M12 A (Metal) > Receptacle > Female Connector > Front Fastened

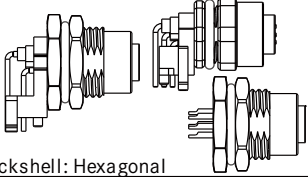
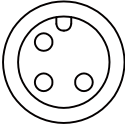
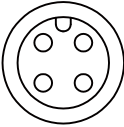
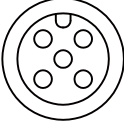
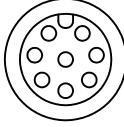
					
Backshell: Hexagonal					
Type	Mounting Thread	3 Contacts	4 Contacts	5 Contacts	8 Contacts
PCB Pin (180°)	PG9	12-03PFFP-SF8001	12-04PFFP-SF8001	12-05PFFP-SF8001	12-08PFFP-SF8001
	M16.0	12-03PFFP-SF8003	12-04PFFP-SF8003	12-05PFFP-SF8003	12-08PFFP-SF8003
		12-03PFFP-SF8004	12-04PFFP-SF8004	12-05PFFP-SF8004	12-08PFFP-SF8004
PCB Pin (90°)	M12	12-03PFFR-SF7001	12-04PFFR-SF7001	12-05PFFR-SF7001	12-08PFFR-SF7001
	M12 (Shielded)	12S-03PFFR-SF7001	12S-04PFFR-SF7001	12S-05PFFR-SF7001	12S-08PFFR-SF7001
	PG9	12-03PFFR-SF8001	12-04PFFR-SF8001	12-05PFFR-SF8001	-
	M16.0	12-03PFFR-SF8003	12-04PFFR-SF8003	12-05PFFR-SF8003	-
Solder Pin (180°)	PG9	12-03PFFS-SF8001	12-04PFFS-SF8001	12-05PFFS-SF8001	12-08PFFS-SF8001
	M16.0	12-03PFFS-SF8003	12-04PFFS-SF8003	12-05PFFS-SF8003	12-08PFFS-SF8003
Wire Leads (150mm)	PG9	12-03PFFS-SF8B15	12-04PFFS-SF8B15	12-05PFFS-SF8B15	12-08PFFS-SF8B15
	M16.0	12-03PFFS-SF8C15	12-04PFFS-SF8C15	12-05PFFS-SF8C15	12-08PFFS-SF8C15
Wire Leads (300mm)	PG9	12-03PFFS-SF8B30	12-04PFFS-SF8B30	12-05PFFS-SF8B30	12-08PFFS-SF8B30
	M16.0	12-03PFFS-SF8C30	12-04PFFS-SF8C30	12-05PFFS-SF8C30	12-08PFFS-SF8C30
Wire Leads (500mm)	PG9	12-03PFFS-SF8B50	12-04PFFS-SF8B50	12-05PFFS-SF8B50	12-08PFFS-SF8B50
	M16.0	12-03PFFS-SF8C50	12-04PFFS-SF8C50	12-05PFFS-SF8C50	12-08PFFS-SF8C50

∟ M12 A (Metal) > Receptacle > Female Connector > Rear Fastened

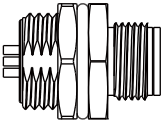
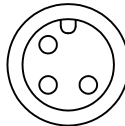
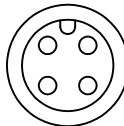
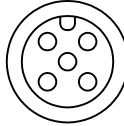
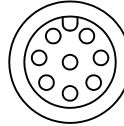
					
Type	Mounting Thread	3 Contacts	4 Contacts	5 Contacts	8 Contacts
Solder Pin (180°)	PG9	12-03PFFS-SH8001	12-04PFFS-SH8001	12-05PFFS-SH8001	12-08PFFS-SH8001
	M16.0	12-03PFFS-SH8003	12-04PFFS-SH8003	12-05PFFS-SH8003	12-08PFFS-SH8003
Wire Leads (150mm)	PG9	12-03PFFS-SH8B15	12-04PFFS-SH8B15	12-05PFFS-SH8B15	12-08PFFS-SH8B15
Wire Leads (300mm)	PG9	12-03PFFS-SH8B30	12-04PFFS-SH8B30	12-05PFFS-SH8B30	12-08PFFS-SH8B30
Wire Leads (500mm)	PG9	12-03PFFS-SH8B50	12-04PFFS-SH8B50	12-05PFFS-SH8B50	12-08PFFS-SH8B50

∟ **M12 A (Metal) > Overmolded with cable > Male Connector > Right Angle**

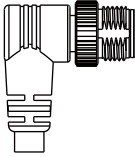
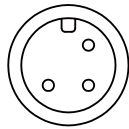
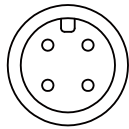
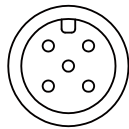
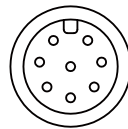
				
Type	3 Contacts	4 Contacts	5 Contacts	8 Contacts
With Strain Relief	12-03AMMM-SR7	12-04AMMM-SR7	12-05AMMM-SR7	12-08AMMM-SR7
Without Strain Relief	12-03BMMM-SR7 12-03BMMM-SR8	12-04BMMM-SR7 12-04BMMM-SR8	12-05BMMM-SR7 12-05BMMM-SR8	12-08BMMM-SR7 12-08BMMM-SR8

∟ **M12 A (Metal) > Overmolded with cable > Male Connector > Straight**

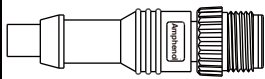
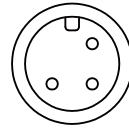
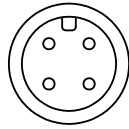
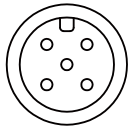
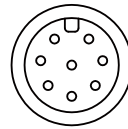
				
Type	3 Contacts	4 Contacts	5 Contacts	8 Contacts
With Strain Relief	12-03AMMM-SL7	12-04AMMM-SL7	12-05AMMM-SL7	12-08AMMM-SL7
Without Strain Relief	12-03BMMM-SL7 12-03BMMM-SL8	12-04BMMM-SL7 12-04BMMM-SL8	12-05BMMM-SL7 12-05BMMM-SL8	12-08BMMM-SL7 12-08BMMM-SL8
	12S-03BMMM-SL7 (Shielded)	12S-04BMMM-SL7 (Shielded)	12S-05BMMM-SL7 (Shielded)	12S-08BMMM-SL7 (Shielded)

Cable Type	1M	3M	5M	10M
PVC	A01	A02	A05	A10
PU	B01	B02	B05	B10

* Design and specification are subject to change without notice.

M12 A Code (Metal)

Overmolded with cable > Female Connector



IP 67 . 68 

Receptacle | Unmated
Overmolded with Cable | Mated
Field Installable | Mated

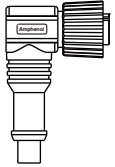
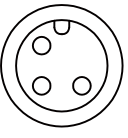
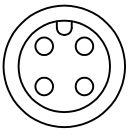
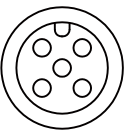
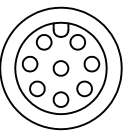
➤ **M12 A (Metal) > Overmolded with cable > Female Connector > Right Angle**

				
Type	3 Contacts	4 Contacts	5 Contacts	8 Contacts
With Strain Relief	12-03AFFM-SR7	12-04AFFM-SR7	12-05AFFM-SR7	12-08AFFM-SR7
Without Strain Relief	12L-03BFFM-SR7 (With LED)	12-04BFFM-SR8	12-05BFFM-SR8	12-08BFFM-SR8
	12-03BFFM-SR8			

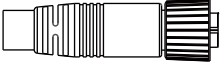
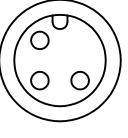
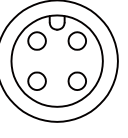
➤ **M12 A (Metal) > Overmolded with cable > Female Connector > Straight**

				
Type	3 Contacts	4 Contacts	5 Contacts	8 Contacts
With Strain Relief	12-03AFFM-SL7	12-04AFFM-SL7	12-05AFFM-SL7	12-08AFFM-SL7
Without Strain Relief	12S-03BFFM-SL7 (Shielded)	12S-04BFFM-SL7 (Shielded)	12S-05BFFM-SL7 (Shielded)	12S-08BFFM-SL7 (Shielded)
	12-03BFFM-SL8	12-04BFFM-SL8	12-05BFFM-SL8	12-08BFFM-SL8

Cable Type	1M	3M	5M	10M
PVC	A01	A02	A05	A10
PU	B01	B02	B05	B10

➤ M12 A (Metal) > Field Installable > Male Connector > Right Angle

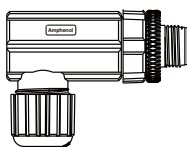
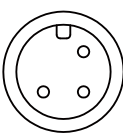
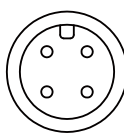
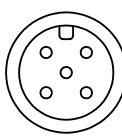
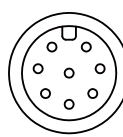
					
Type	Contact Type	3 Contacts	4 Contacts	5 Contacts	8 Contacts
Without Strain Relief	Screw Type	12-03BMMB-SR700 1	12-04BMMB-SR700 1	12-05BMMB-SR700 1	-



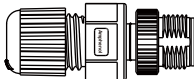
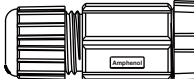
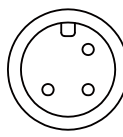
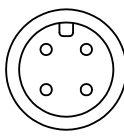
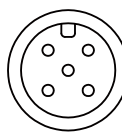
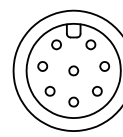

➤ M12 A (Metal) > Field Installable > Male Connector > Straight

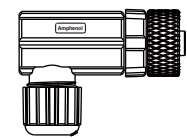
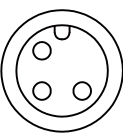
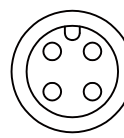
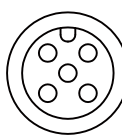
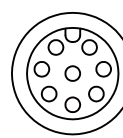
 Solder Type  Screw Type					
Type	Contact Type	3 Contacts	4 Contacts	5 Contacts	8 Contacts
Without Strain Relief	Solder Type	12-03BMMA-SL800 1	12-04BMMA-SL800 1	12-05BMMA-SL800 1	12-08BMMA-SL800 1
	Screw Type	12-03BMMB-SL700 1	12-04BMMB-SL700 1	12-05BMMB-SL700 1	-

➤ M12 A (Metal) > Field Installable > Female Connector > Right Angle

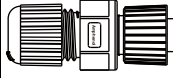
					
Type	Contact Type	3 Contacts	4 Contacts	5 Contacts	8 Contacts
Without Strain Relief	Screw Type	12-03BFFB-SR700 1	12-04BFFB-SR700 1	12-05BFFB-SR700 1	-

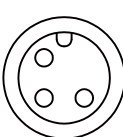
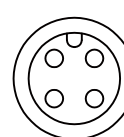
➤ M12 A (Metal) > Field Installable > Female Connector > Straight

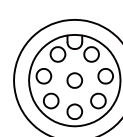
 Solder Type  Screw Type					
Type	Contact Type	3 Contacts	4 Contacts	5 Contacts	8 Contacts
Without Strain Relief	Solder Type	12-03BFFA-SL800 1	12-04BFFA-SL800 1	12-05BFFA-SL800 1	12-08BFFA-SL800 1
	Screw Type	12-03BFFB-SL700 1	12-04BFFB-SL700 1	12-05BFFB-SL700 1	-

* Design and specification are subject to change without notice.

∟ M12 A (Plastic) > Receptacle > Male Connector > Front Fastened

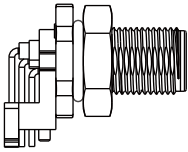
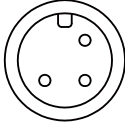
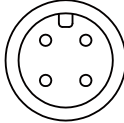
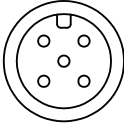
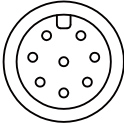
					
Backshell: Hexagonal					
Type	Mounting Thread	3 Contacts	4 Contacts	5 Contacts	8 Contacts
PCB Pin (90°)	M12	12P-03PMMR-SF8001	12P-04PMMR-SF8001	12P-05PMMR-SF8001	-

∟ M12 A (Plastic) > Receptacle > Female Connector > Front Fastened

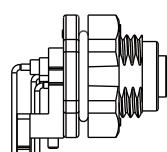
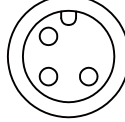
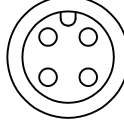
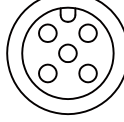
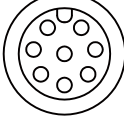
					
Backshell: Hexagonal					
Type	Mounting Thread	3 Contacts	4 Contacts	5 Contacts	8 Contacts
PCB Pin (180°)	M16.0	12P-03PFFP-SF8003	12P-04PFFP-SF8003	12P-05PFFP-SF8003	12P-08PFFP-SF8003
PCB Pin (90°)	M16.0	12P-03PFFR-SF8003	12P-04PFFR-SF8003	12P-05PFFR-SF8003	-
Solder Pin (180°)	M16.0	12P-03PFFS-SF8003	12P-04PFFS-SF8003	12P-05PFFS-SF8003	12P-08PFFS-SF8003

➤ **M12 A (Plastic) > Overmolded with cable > Male Connector > Right Angle**

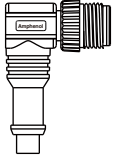
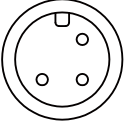
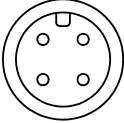
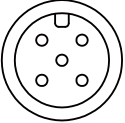
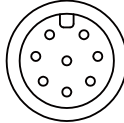
				
Type	3 Contacts	4 Contacts	5 Contacts	8 Contacts
Without Strain Relief	12P-03BMMM-SR8	12P-04BMMM-SR8	12P-05BMMM-SR8	12P-08BMMM-SR8

➤ **M12 A (Plastic) > Overmolded with cable > Male Connector > Straight**

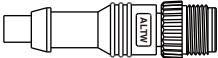
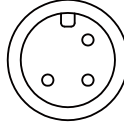
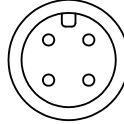
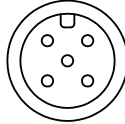
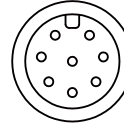
				
Type	3 Contacts	4 Contacts	5 Contacts	8 Contacts
Without Strain Relief	12P-03BMMM-SL8	12P-04BMMM-SL8	12P-05BMMM-SL8	12P-08BMMM-SL8

➤ **M12 A (Plastic) > Overmolded with cable > Female Connector > Right Angle**

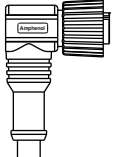
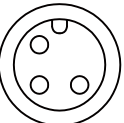
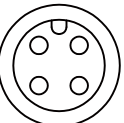
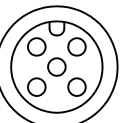
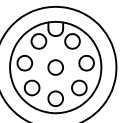
				
Type	3 Contacts	4 Contacts	5 Contacts	8 Contacts
Without Strain Relief	12P-03BFFM-SR8	12P-04BFFM-SR8	12P-05BFFM-SR8	12P-08BFFM-SR8

➤ **M12 A (Plastic) > Overmolded with cable > Female Connector > Straight**

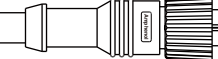
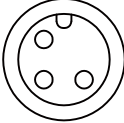
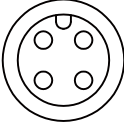
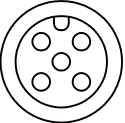
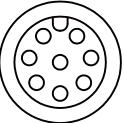
				
Type	3 Contacts	4 Contacts	5 Contacts	8 Contacts
Without Strain Relief	12P-03BFFM-SL8	12P-04BFFM-SL8	12P-05BFFM-SL8	12P-08BFFM-SL8

Cable Type	1M	3M	5M	10M
PVC	A01	A02	A05	A10
PU	B01	B02	B05	B10

* Design and specification are subject to change without notice.

∟ M12 A (Plastic) > Field Installable > Male Connector > Right Angle

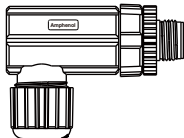
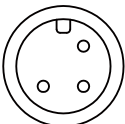
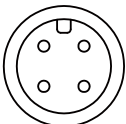
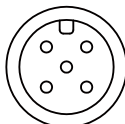
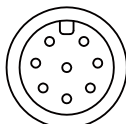
					
Type	Contact Type	3 Contacts	4 Contacts	5 Contacts	8 Contacts
Without Strain Relief	Solder Type	-	-	-	-
	Screw Type	12P-03BMMB-SR7001	12P-04BMMB-SR7001	12P-05BMMB-SR7001	-

∟ M12 A (Plastic) > Field Installable > Male Connector > Straight

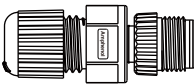
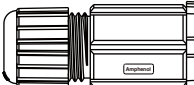
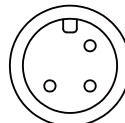
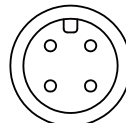
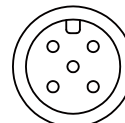
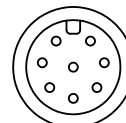
 Solder Type  Screw Type					
Type	Contact Type	3 Contacts	4 Contacts	5 Contacts	8 Contacts
Without Strain Relief	Solder Type	12P-03BMMA-SL7001 12P-03BMMA-SL8001	12P-04BMMA-SL7001 12P-04BMMA-SL8001	12P-05BMMA-SL7001 12P-05BMMA-SL8001	12P-08BMMA-SL8001
	Screw Type	12P-03BMMB-SL7001	12P-04BMMB-SL7001	12P-05BMMB-SL7001	

∟ M12 A (Plastic) > Field Installable > Female Connector > Right Angle

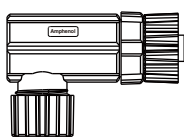
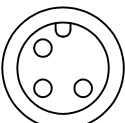
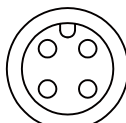
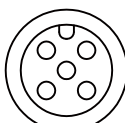
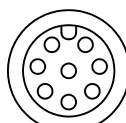
					
Type	Contact Type	3 Contacts	4 Contacts	5 Contacts	8 Contacts
Without Strain Relief	Solder Type	-	-	-	-
	Screw Type	12P-03BFFB-SR7001	12P-04BFFB-SR7001	12P-05BFFB-SR7001	-

∟ M12 A (Plastic) > Field Installable > Female Connector > Straight

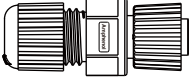
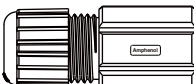
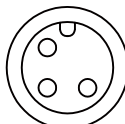
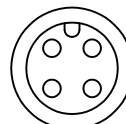
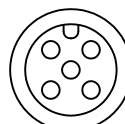
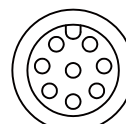
 Solder Type  Screw Type					
Type	Contact Type	3 Contacts	4 Contacts	5 Contacts	8 Contacts
Without Strain Relief	Solder Type	12P-03BFFA-SL8001	12P-04BFFA-SL8001	12P-05BFFA-SL8001	12P-08BFFA-SL8001
	Screw Type	12P-03BFFB-SL7001	12P-04BFFB-SL7001	12P-05BFFB-SL7001	

▾ M12 B (Metal) > Receptacle > Male Connector > Front Fastened

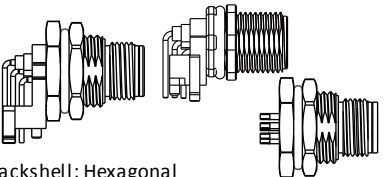
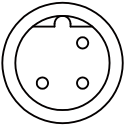
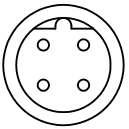
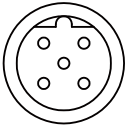

				
Backshell: Hexagonal		3 Contacts	4 Contacts	5 Contacts
Type	Mounting Thread	3 Contacts	4 Contacts	5 Contacts
PCB Pin (180°)	PG9	12B-03PMMP-SF8001	12B-04PMMP-SF8001	12B-05PMMP-SF8001
	M16	12B-03PMMP-SF8003	12B-04PMMP-SF8003 12B-04PMMP-SF8004	12B-05PMMP-SF8003 12B-05PMMP-SF8004
PCB Pin (90°)	M12	-	-	SBS-05PMMR-SF7001
	PG9	12B-03PMMR-SF8001	12B-04PMMR-SF8001	12B-05PMMR-SF8001 12B-05PMMR-SF7001
	M16	12B-03PMMR-SF8003	12B-04PMMR-SF8003	12B-05PMMR-SF8003
Solder Pin (180°)	PG9	12B-03PMMS-SF8001	12B-04PMMS-SF8001	12B-05PMMS-SF8001
	M16	12B-03PMMS-SF8003	12B-04PMMS-SF8003 12B-04PMMS-SF8004	12B-05PMMS-SF8003 12B-05PMMS-SF8004
Wire Leads (150mm)	PG9	-	-	12B-05PMMS-SF8B15
	M16	-	-	12B-05PMMS-SF8C15
Wire Leads (300mm)	PG9	-	-	12B-05PMMS-SF8B30
	M16	-	-	12B-05PMMS-SF8C30
Wire Leads (500mm)	PG9	-	-	12B-05PMMS-SF8B50
	M16	-	-	12B-05PMMS-SF8C50

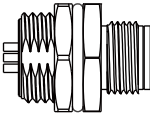
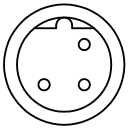
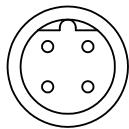
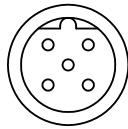
▾ M12 B (Metal) > Receptacle > Male Connector > Rear Fastened

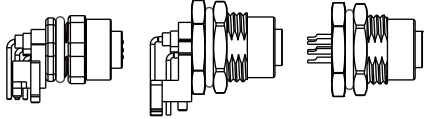
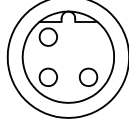
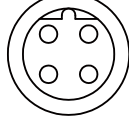

				
Type	Mounting Thread	3 Contacts	4 Contacts	5 Contacts
PCB Pin (180°)	PG9	12B-03PMMS-SH8001	12B-04PMMS-SH8001	12B-05PMMS-SH8001
	M16	12B-03PMMS-SH8003	12B-04PMMS-SH8003 12B-04PMMS-SH8004	12B-05PMMS-SH8003 12B-05PMMS-SH8004
Wire Leads (150mm)	PG9	-	-	12B-05PMMS-SH8B15
	M16	-	-	12B-05PMMS-SH8C15
Wire Leads (300mm)	PG9	-	-	12B-05PMMS-SH8B30
	M16	-	-	12B-05PMMS-SH8C30
Wire Leads (500mm)	PG9	-	-	12B-05PMMS-SH8B50
	M16	-	-	12B-05PMMS-SH8C50

* Design and specification are subject to change without notice.

∟ **M12 B (Metal) Receptacle > Female Connector > Front Fastened**

				
Backshell: Hexagonal				
Type	Mounting Thread	3 Contacts	4 Contacts	5 Contacts
PCB Pin (180°)	PG9	12B-03PFFP-SF8001	12B-04PFFP-SF8001	12B-05PFFP-SF8001
	M16	12B-03PFFP-SF8003	12B-04PFFP-SF8003 12B-04PFFP-SF8004 12B-04PFFP-SF8005	12B-05PFFP-SF8003 12B-05PFFP-SF8004 12B-05PFFP-SF8005
PCB Pin (90°)	M12	-	-	SBS-05PFFR-SF7001
	PG9	12B-03PFFR-SF8001	12B-04PFFR-SF8001	12B-05PFFR-SF8001 12B-05PFFR-SF7001
	M16	12B-03PFFR-SF8003	12B-04PFFR-SF8003	12B-05PFFR-SF8003
Solder Pin (180°)	PG9	12B-03PFFS-SF8001	12B-04PFFS-SF8001	12B-05PFFS-SF8001
	M16	12B-03PFFS-SF8003	12B-04PFFS-SF8003 12B-04PFFS-SF8004	12B-05PFFS-SF8003 12B-05PFFS-SF8004
Wire Leads (150mm)	PG9	-	-	12B-05PFFS-SF8B15
	M16	-	-	12B-05PFFS-SF8C15
Wire Leads (300mm)	PG9	-	-	12B-05PFFS-SF8B30
	M16	-	-	12B-05PFFS-SF8C30
Wire Leads (500mm)	PG9	-	-	12B-05PFFS-SF8B50
	M16	-	-	12B-05PFFS-SF8C50

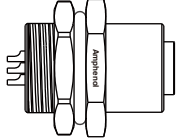
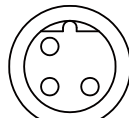
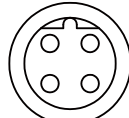
∟ **M12 B (Metal) > Receptacle > Female Connector > Rear Fastened**

				
Type	Mounting Thread	3 Contacts	4 Contacts	5 Contacts
PCB Pin (180°)	PG9	12B-03PFFS-SH8001	12B-04PFFS-SH8001	12B-05PFFS-SH8001
	M16	12B-03PFFS-SH8003	12B-04PFFS-SH8003 12B-04PFFS-SH8004	12B-05PFFS-SH8003 12B-05PFFS-SH8004
Wire Leads (150mm)	PG9	-	-	12B-05PFFS-SH8B15
Wire Leads (300mm)	PG9	-	-	12B-05PFFS-SH8B30
Wire Leads (500mm)	PG9	-	-	12B-05PFFS-SH8B50

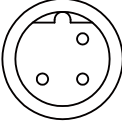
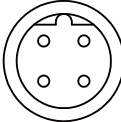
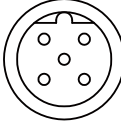

∟ **M12 B (Metal) > Overmolded with cable > Male Connector > Right Angle**

			
Type	3 Contacts	4 Contacts	5 Contacts
Without Strain Relief	12B-03BMMM-SR8	12B-04BMMM-SR8	12B-05BMMM-SR8

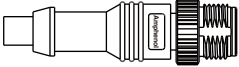
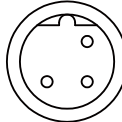
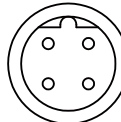
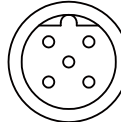

∟ **M12 B (Metal) > Overmolded with cable > Male Connector > Straight**

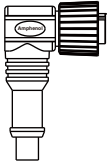
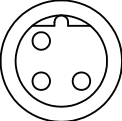
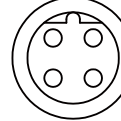
			
Type	3 Contacts	4 Contacts	5 Contacts
Without Strain Relief	12B-03BMMM-SL8	12B-04BMMM-SL8	12B-05BMMM-SL8

∟ **M12 B (Metal) > Overmolded with cable > Female Connector > Right Angle**

			
Type	3 Contacts	4 Contacts	5 Contacts
Without Strain Relief	12B-03BFFM-SR8	12B-04BFFM-SR8	12B-05BFFM-SR8

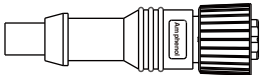
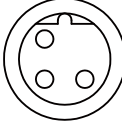
∟ **MM12 B (Metal) > Overmolded with cable > Female Connector > Straight**

			
Type	3 Contacts	4 Contacts	5 Contacts
Without Strain Relief	12B-03BFFM-SL8	12B-04BFFM-SL8	12B-05BFFM-SL8



Cable Type	1M	3M	5M	10M
PVC	A01	A02	A05	A10
PU	B01	B02	B05	B10

* Design and specification are subject to change without notice.

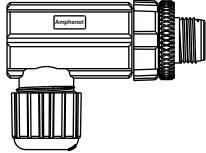
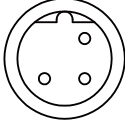
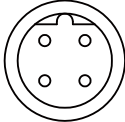
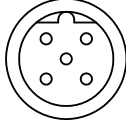

∟ M12 B (Metal) > Field Installable > Male Connector > Right Angle

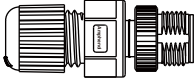
				
Type	Contact Type	3 Contacts	4 Contacts	5 Contacts
Without Strain Relief	Screw Type	12B-03BMMB-SR7001	12B-04BMMB-SR7001	12B-05BMMB-SR7001

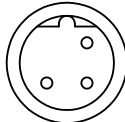
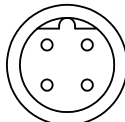
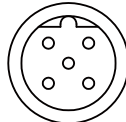

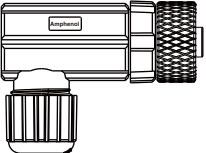
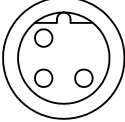
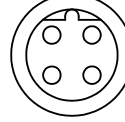

∟ M12 B (Metal) > Field Installable > Male Connector > Straight

 Solder Type  Screw Type				
Type	Contact Type	3 Contacts	4 Contacts	5 Contacts
Without Strain Relief	Solder Type	12B-03BMMA-SL8001	12B-04BMMA-SL8001	12B-05BMMA-SL8001
	Screw Type	12B-03BMMB-SL7001	12B-04BMMB-SL7001	12B-05BMMB-SL7001

∟ M12 B (Metal) > Field Installable > Female Connector > Right Angle

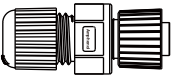
				
Type	Contact Type	3 Contacts	4 Contacts	5 Contacts
Without Strain Relief	Screw Type	12B-03BFFB-SR7001	12B-04BFFB-SR7001	12B-05BFFB-SR7001

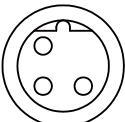
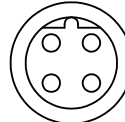
∟ M12 B (Metal) > Field Installable > Female Connector > Straight

 Solder Type  Screw Type				
Type	Contact Type	3 Contacts	4 Contacts	5 Contacts
Without Strain Relief	Solder Type	12B-03BFFA-SL8001	12B-04BFFA-SL8001	12B-05BFFA-SL8001
	Screw Type	12B-03BFFB-SL7001	12B-04BFFB-SL7001	12B-05BFFB-SL7001

∟ **M12 B (Plastic) > Receptacle > Male Connector > Front Fastened**

Backshell: Hexagonal				
Type	Mounting Thread	3 Contacts	4 Contacts	5 Contacts
PCB Pin (90°)	M12	-	-	SBP-05PMMR-SF8001

∟ **M12 B (Plastic) > Receptacle > Female Connector > Front Fastened**

Backshell: Hexagonal				
Type	Mounting Thread	3 Contacts	4 Contacts	5 Contacts
PCB Pin (90°)	M12	-	-	SBP-05PFFR-SF8001

∟ **M12 B (Plastic) > Overmolded with cable > Male Connector > Right Angle**

Type	3 Contacts	4 Contacts	5 Contacts
Without Strain Relief	SBP-03BMMM-SR8	SBP-04BMMM-SR8	SBP-05BMMM-SR8

∟ **M12 B (Plastic) > Overmolded with cable > Male Connector > Straight**

Type	3 Contacts	4 Contacts	5 Contacts
Without Strain Relief	SBP-03BMMM-SL8	SBP-04BMMM-SL8	SBP-05BMMM-SL8

Cable Type	1M	3M	5M	10M
PVC	A01	A02	A05	A10
PU	B01	B02	B05	B10

* Design and specification are subject to change without notice.

M12 B Code (Plastic)

Overmolded with cable > Female Connector
 Field Installable > Male Connector

IP 67 . 68 9

Receptacle | Unmated
 Overmolded with Cable | Mated
 Field Installable | Mated

∟ **M12 B (Plastic) > Overmolded with cable > Female Connector > Right Angle**

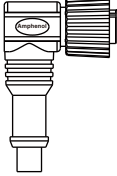
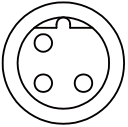
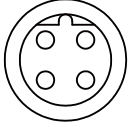
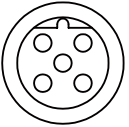
			
Type	3 Contacts	4 Contacts	5 Contacts
Without Strain Relief	SBP-03BFFM-SR8	SBP-04BFFM-SR8	SBP-05BFFM-SR8

∟ **M12 B (Plastic) > Overmolded with cable > Female Connector > Straight**

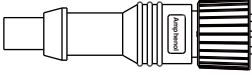
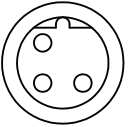
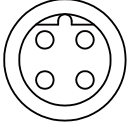
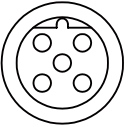
			
Type	3 Contacts	4 Contacts	5 Contacts
Without Strain Relief	SBP-03BFFM-SL8	SBP-04BFFM-SL8	SBP-05BFFM-SL8

Cable Type	1M	3M	5M	10M
PVC	A01	A02	A05	A10
PU	B01	B02	B05	B10

∟ **M12 B (Plastic) > Field Installable > Male Connector > Right Angle**

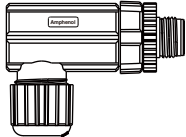
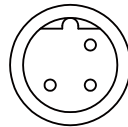
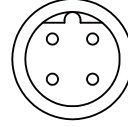
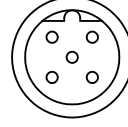
				
Type	Contact Type	3 Contacts	4 Contacts	5 Contacts
Without Strain Relief	Screw Type	SBP-03BMMB-SR7001	SBP-04BMMB-SR7001	SBP-05BMMB-SR7001

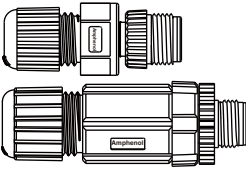
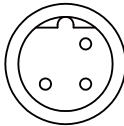
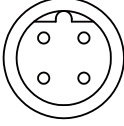
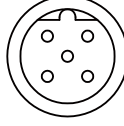

∟ **M12 B (Plastic) > Field Installable > Male Connector > Straight**

		Solder Type			
		Screw Type			
Type	Contact Type	3 Contacts	4 Contacts	5 Contacts	
Without Strain Relief	Solder Type	SBP-03BMMA-SL800 1	SBP-04BMMA-SL800 1	SBP-05BMMA-SL800 1	
	Screw Type	SBP-03BMMB-SL700 1	SBP-04BMMB-SL700 1	SBP-05BMMB-SL700 1	

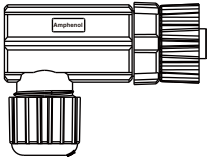
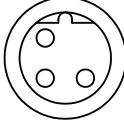
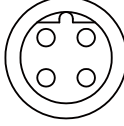
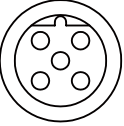
∟ **M12 B (Plastic) > Field Installable > Female Connector > Right Angle**

				
Type	Contact Type	3 Contacts	4 Contacts	5 Contacts
Without Strain Relief	Screw Type	SBP-03BFFB-SR700 1	SBP-04BFFB-SR700 1	SBP-05BFFB-SR700 1

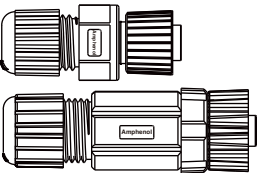
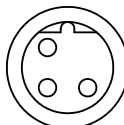
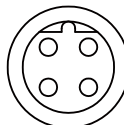
∟ **M12 B (Plastic) > Field Installable > Female Connector > Straight**

				
Type	Contact Type	3 Contacts	4 Contacts	5 Contacts
Without Strain Relief	Solder Type	SBP-03BFFA-SL800 1	SBP-04BFFA-SL800 1	SBP-05BFFA-SL800 1
	Screw Type	SBP-03BFFB-SL700 1	SBP-04BFFB-SL700 1	SBP-05BFFB-SL700 1

* Design and specification are subject to change without notice.

∟ M12 D (Metal) > Receptacle > Male Connector > Front Fastened

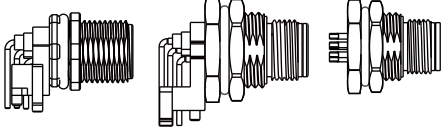
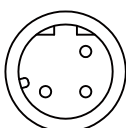
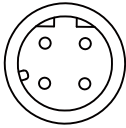
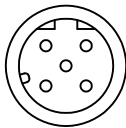
				
Backshell: Hexagonal				
Type	Mounting Thread	3 Contacts	4 Contacts	5 Contacts
PCB Pin (180°)	PG9	-	12D-04PMMP-SF8001	12D-05PMMP-SF8001
	M16.0	-	12D-04PMMP-SF8003 12D-04PMMP-SF8004	12D-05PMMP-SF8003 12D-05PMMP-SF8004
PCB Pin (90°)	PG9	-	12D-04PMMR-SF7001 12D-04PMMR-SF8001	-
	M12	-	12D-04PMMR-SF7007	-
	M12 (Shielded)	-	SDS-04PMMR-SF7007	-
Solder Pin (180°)	PG9	12D-03PMMS-SF8001	12D-04PMMS-SF8001	12D-05PMMS-SF8001
	M16.0	-	12D-04PMMS-SF8003 12D-04PMMS-SF8004	12D-05PMMS-SF8003 12D-05PMMS-SF8004
Wire Leads (150mm)	PG9	-	12D-04PMMS-SF8B15	-
	M16.0	-	12D-04PMMS-SF8C15	-
Wire Leads (300mm)	PG9	-	12D-04PMMS-SF8B30	-
	M16.0	-	12D-04PMMS-SF8C30	-
Wire Leads (500mm)	PG9	-	12D-04PMMS-SF8B50	-
	M16.0	-	12D-04PMMS-SF8C50	-

∟ M12 D (Metal) > Receptacle > Male Connector > Rear Fastened

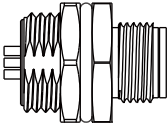
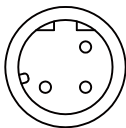
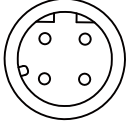
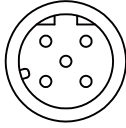
				
Type	Mounting Thread	3 Contacts	4 Contacts	5 Contacts
Solder Pin (180°)	PG9	12D-03PMMS-SH8001	12D-04PMMS-SH8001	12D-05PMMS-SH8001
	M16.0	-	12D-04PMMS-SH8003 12D-04PMMS-SH8004	12D-05PMMS-SH8003 12D-04PMMS-SH8004
Wire Leads (150mm)	PG9	-	12D-04PMMS-SH8B15	-
	M16.0	-	12D-04PMMS-SH8C15	-
Wire Leads (300mm)	PG9	-	12D-04PMMS-SH8B30	-
	M16.0	-	12D-04PMMS-SH8C30	-
Wire Leads (500mm)	PG9	-	12D-04PMMS-SH8B50	-
	M16.0	-	12D-04PMMS-SH8C50	-

∟ **M12 D (Metal) > Receptacle > Female Connector > Front Fastened**

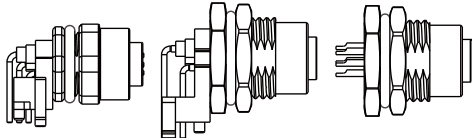
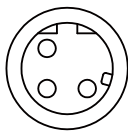
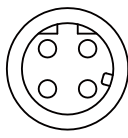
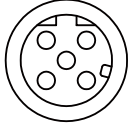
				
Backshell: Hexagonal				
Type	Mounting Thread	3 Contacts	4 Contacts	5 Contacts
PCB Pin (180°)	PG9	12D-03PFFP-SF8001	12D-04PFFP-SF8001	12D-05PFFP-SF8001
	M16.0	-	12D-04PFFP-SF8003 12D-04PFFP-SF8004 12D-04PFFP-SF8005	12D-05PFFP-SF8003 12D-05PFFP-SF8004 12D-05PFFP-SF8005
PCB Pin (90°)	PG9	12D-03PFFR-SF8001	12D-04PFFR-SF7001 12D-04PFFR-SF8001	12D-05PFFR-SF8001
	M16.0	12D-03PFFR-SF8003	12D-04PFFR-SF8003	12D-05PFFR-SF8003
	M12	-	12D-04PFFR-SF7007	-
	M12 (Shielded)		SDS-04PFFR-SF7007	
Solder Pin (180°)	PG9	12D-03PFFS-SF8001	12D-04PFFS-SF8001	12D-05PFFS-SF8001
	M16.0	12D-03PFFS-SF8003	12D-04PFFS-SF8003 12D-04PFFS-SF8004	12D-05PFFS-SF8003 12D-05PFFS-SF8004
Wire Leads (150mm)	PG9	-	12D-04PFFS-SF8B15	-
	M16.0	-	12D-04PFFS-SF8C15	-
Wire Leads (300mm)	PG9	-	12D-04PFFS-SF8B30	-
	M16.0	-	12D-04PFFS-SF8C30	-
Wire Leads (500mm)	PG9	-	12D-04PFFS-SF8B50	-
	M16.0	-	12D-04PFFS-SF8C50	-

∟ **M12 D (Metal) > Receptacle > Female Connector > Rear Fastened**

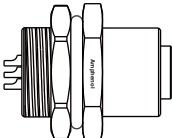
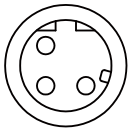
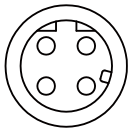
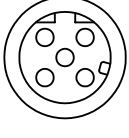
				
Type	Mounting Thread	3 Contacts	4 Contacts	5 Contacts
Solder Pin (180°)	PG9	12D-03PFFS-SH8001	12D-04PFFS-SH8001	12D-05PFFS-SH8001
	M16.0	12D-03PFFS-SH8003	12D-04PFFS-SH8003 12D-04PFFS-SH8004	12D-05PFFS-SH8003 12D-05PFFS-SH8004
Wire Leads (150mm)	PG9	-	12D-04PFFS-SH8B15	-
Wire Leads (300mm)	PG9	-	12D-04PFFS-SH8B30	-
Wire Leads (500mm)	PG9	-	12D-04PFFS-SH8B50	-

* Design and specification are subject to change without notice.

M12 D Code (Metal)

Overmolded with cable > Male / Female Connector

IP 67 . 68 9

Receptacle | Unmated
Overmolded with Cable | Mated
Field Installable | Mated

➤ **M12 D (Metal) > Overmolded with cable > Male Connector > Right Angle**

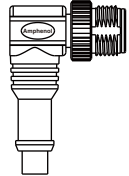
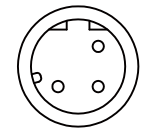
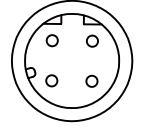
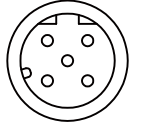
			
Type	3 Contacts	4 Contacts	5 Contacts
Without Strain Relief	12D-03BMMM-SR8	12D-04BMMM-SR8	12D-05BMMM-SR8

➤ **M12 D (Metal) > Overmolded with cable > Male Connector > Straight**

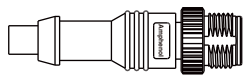
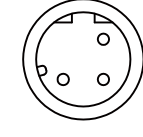
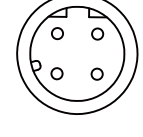
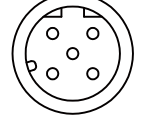
			
Type	3 Contacts	4 Contacts	5 Contacts
Without Strain Relief	12D-03BMMM-SL8	12D-04BMMM-SL8	12D-05BMMM-SL8

➤ **M12 D (Metal) > Overmolded with cable > Female Connector > Right Angle**

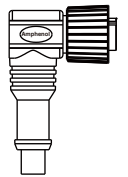
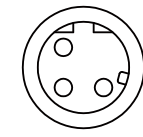
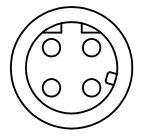
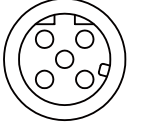
			
Type	3 Contacts	4 Contacts	5 Contacts
Without Strain Relief	12D-03BFFM-SR8	12D-04BFFM-SR8	12D-05BFFM-SR8

➤ **M12 D (Metal) > Overmolded with cable > Female Connector > Straight**

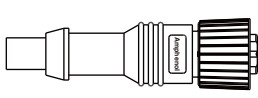
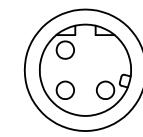
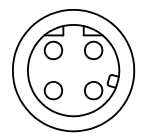
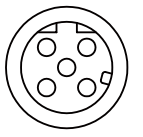
			
Type	3 Contacts	4 Contacts	5 Contacts
Without Strain Relief	12D-03BFFM-SL8	12D-04BFFM-SL8	12D-05BFFM-SL8

Cable Type	1M	3M	5M	10M
PVC	A01	A02	A05	A10
PU	B01	B02	B05	B10

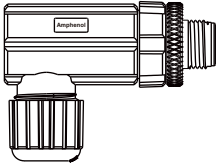
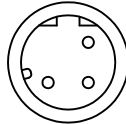
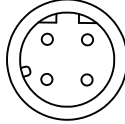
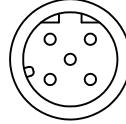

∟ **M12 D (Metal) > Field Installable > Male Connector > Right Angle**

				
Type	Contact Type	3 Contacts	4 Contacts	5 Contacts
Without Strain Relief	Screw Type	12D-03BMMB-SR7001	12D-04BMMB-SR7001	12D-05BMMB-SR7001

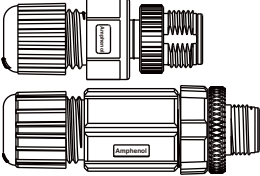
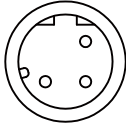
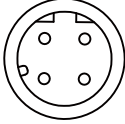
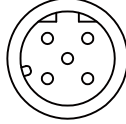
∟ **M12 D (Metal) > Field Installable > Male Connector > Straight**

				
Type	Contact Type	3 Contacts	4 Contacts	5 Contacts
Without Strain Relief	Solder Type	12D-03BMMA-SL8001	12D-04BMMA-SL8001	12D-05BMMA-SL8001
	Screw Type	12D-03BMMB-SL7001	12D-04BMMB-SL7001	12D-05BMMB-SL7001

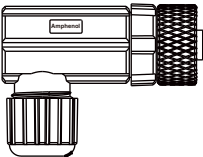
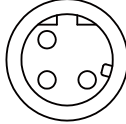
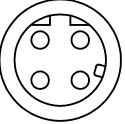
∟ **M12 D (Metal) > Field Installable > Female Connector > Right Angle**

				
Type	Contact Type	3 Contacts	4 Contacts	5 Contacts
Without Strain Relief	Screw Type	12D-03BFFB-SR7001	12D-04BFFB-SR7001	12D-05BFFB-SR7001

∟ **M12 D (Metal) > Field Installable > Female Connector > Straight**

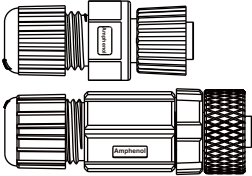
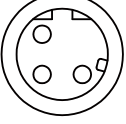
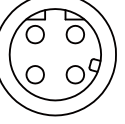
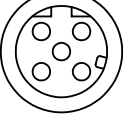
				
Type	Contact Type	3 Contacts	4 Contacts	5 Contacts
Without Strain Relief	Solder Type	12D-03BFFA-SL8001	12D-04BFFA-SL8001	12D-05BFFA-SL8001
	Screw Type	12D-03BFFB-SL7001	12D-04BFFB-SL7001	12D-05BFFB-SL7001

* Design and specification are subject to change without notice.

M12 D Code (Plastic)

Receptacle > Male / Female Connector
 Overmolded with cable > Male Connector

IP 67 . 68 **9**

Receptacle | Unmated
 Overmolded with Cable | Mated
 Field Installable | Mated

≧ **M12 D (Plastic) > Receptacle > Male Connector > Front Fastened**

Backshell: Hexagonal				
Type	Mounting Thread	3 Contacts	4 Contacts	5 Contacts
PCB Pin (90°)	M12	-	SDP-04PMMR-SF8001	-

≧ **M12 D (Plastic) > Receptacle > Female Connector > Front Fastened**

Backshell: Hexagonal				
Type	Mounting Thread	3 Contacts	4 Contacts	5 Contacts
PCB Pin (90°)	M12	-	SDP-04PFFR-SF8001	-

≧ **M12 D (Plastic) > Overmolded with cable > Male Connector > Right Angle**



Type	3 Contacts	4 Contacts	5 Contacts
Without Strain Relief	SDP-03BMMM-SR8	SDP-04BMMM-SR8	SDP-05BMMM-SR8

≧ **M12 D (Plastic) > Overmolded with cable > Male Connector > Straight**



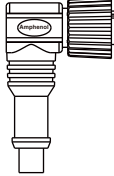
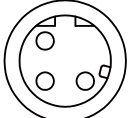
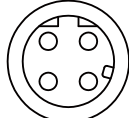

Type	3 Contacts	4 Contacts	5 Contacts
Without Strain Relief	SDP-03BMMM-SL8	SDP-04BMMM-SL8	SDP-05BMMM-SL8

Cable Type	1M	3M	5M	10M
PVC	A01	A02	A05	A10
PU	B01	B02	B05	B10

∨ **M12 D (Plastic) > Overmolded with cable > Female Connector > Right Angle**

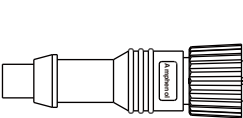
			
Type	3 Contacts	4 Contacts	5 Contacts
Without Strain Relief	SDP-03BFFM-SR8	SDP-04BFFM-SR8	SDP-05BFFM-SR8

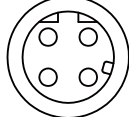
∨ **M12 D (Plastic) > Overmolded with cable > Female Connector > Straight**

			
Type	3 Contacts	4 Contacts	5 Contacts
Without Strain Relief	SDP-03BFFM-SL8	SDP-04BFFM-SL8	SDP-05BFFM-SL8

∨ **M12 D (Plastic) > Field Installable > Male Connector > Right Angle**

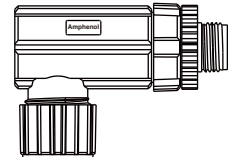
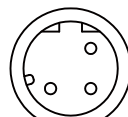
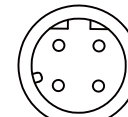
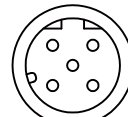
				
Type	Contact Type	3 Contacts	4 Contacts	5 Contacts
Without Strain Relief	Screw Type	SDP-03BMMB-SR700 1	SDP-04BMMB-SR700 1	SDP-05BMMB-SR700 1

∨ **M12 D (Plastic) > Field Installable > Male Connector > Straight**

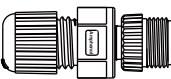
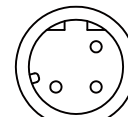
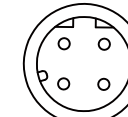
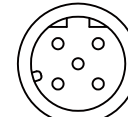
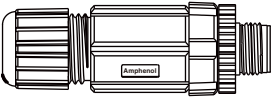

	Solder Type			
	Screw Type			
Type	Contact Type	3 Contacts	4 Contacts	5 Contacts
Without Strain Relief	Solder Type	SDP-03BMMA-SL800 1	SDP-04BMMA-SL800 1	SDP-05BMMA-SL800 1
	Screw Type	SDP-03BMMB-SL700 1	SDP-04BMMB-SL700 1	SDP-05BMMB-SL700 1

* Design and specification are subject to change without notice.

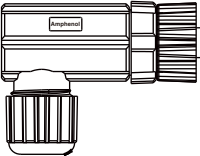
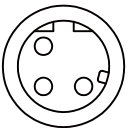
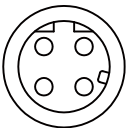
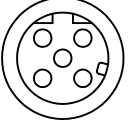
∨ M12 D (Plastic) > Field Installable > Female Connector > Right Angle

				
Type	Contact Type	3 Contacts	4 Contacts	5 Contacts
Without Strain Relief	Screw Type	SDP-03BFFB-SR7001	SDP-04BFFB-SR7001	SDP-05BFFB-SR7001

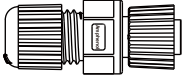

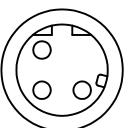
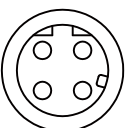
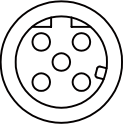
∨ M12 D (Plastic) > Field Installable > Female Connector > Straight

 Solder Type  Screw Type				
Type	Contact Type	3 Contacts	4 Contacts	5 Contacts
Without Strain Relief	Solder Type	SDP-03BFFA-SL8001	SDP-04BFFA-SL8001	SDP-05BFFA-SL8001
	Screw Type	SDP-03BFFB-SL7001	SDP-04BFFB-SL7001	SDP-05BFFB-SL7001

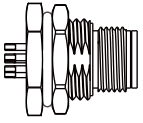
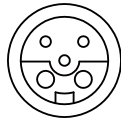

∟ **M12 I (Metal) > Receptacle > Male Connector (Housing) > Front Fastened (Male+Female Contact)**

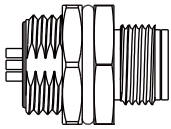
		
Backshell: Hexagonal		
Type	Mounting Thread	5 Contacts
PCB Pin (180°)	PG9	12-05PMIP-SF8001
	M16.0	12-05PMIP-SF8003 12-05PMIP-SF8004
PCB Pin (90°)	PG9	12-05PMIR-SF8001
	M16.0	12-05PMIR-SF8003
Solder Pin (180°)	PG9	12-05PMIS-SF8001
	M16.0	12-05PMIS-SF8003 12-05PMIS-SF8004

∟ **M12 I (Metal) > Receptacle > Male Connector (Housing) > Rear Fastened (Male+Female Contact)**

		
Type	Mounting Thread	5 Contacts
Solder Pin (180°)	PG9	12-05PMIS-SH8001
	M16.0	12-05PMIS-SH8003 12-05PMIS-SH8004

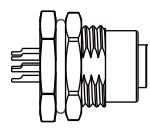
∟ **M12 I (Metal) > Receptacle > Female Connector (Housing) > Front Fastened (Male+Female Contact)**

		
Backshell: Hexagonal		
Type	Mounting Thread	5 Contacts
PCB Pin (180°)	PG9	12-05PFIP-SF8001
	M16.0	12-05PFIP-SF8003 12-05PFIP-SF8004
PCB Pin (90°)	PG9	12-05PFIR-SF8001
	M16.0	12-05PFIR-SF8003
Solder Pin (180°)	PG9	12-05PFIS-SF8001
	M16.0	12-05PFIS-SF8003 12-05PFIS-SF8004

* Design and specification are subject to change without notice.

M12 I Style (Metal)

Receptacle > Female / Male Connector (Housing)
 Overmolded with cable > Male Connector (Housing)



IP 67 . 68 9

Receptacle | Unmated
 Overmolded with Cable | Mated
 Field Installable | Mated

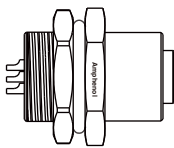
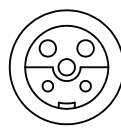

∟ **M12 I (Metal) > Receptacle > Female Connector (Housing) > Rear Fastened (Male+Female Contact)**

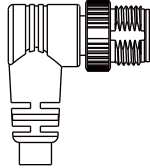
		
Type	Mounting Thread	5 Contacts
Solder Pin (180°)	PG9	12-05PFIS-SH8001
	M16.0	12-05PFIS-SH8003 12-05PFIS-SH8004

∟ **M12 I (Metal) > Overmolded with cable > Male Connector (Housing) > Right Angle (Male+Female Contact)**

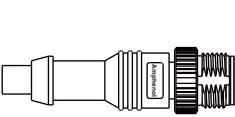

		
Type	5 Contacts	
With Strain Relief	12-05AMIM-SR7	
Without Strain Relief	12-05BMIM-SR8	

∟ **M12 I (Metal) > Overmolded with cable > Male Connector (Housing) > Straight (Male+Female Contact)**

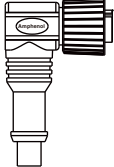

		
Type	5 Contacts	
With Strain Relief	12-05AMIM-SL7	
Without Strain Relief	12-05BMIM-SL8	

Cable Type	1M	3M	5M	10M
PVC	A01	A02	A05	A10
PU	B01	B02	B05	B10

∟ **M12 I (Metal) > Overmolded with cable > Female Connector (Housing) > Right Angle (Male+Female Contact)**

	
Type	5 Contacts
With Strain Relief	12-05AFIM-SR7
Without Strain Relief	12-05BFIM-SR8

∟ **M12 I (Metal) > Overmolded with cable > Female Connector (Housing) > Straight**

	
Type	5 Contacts
With Strain Relief	12-05AFIM-SL7
Without Strain Relief	12-05BFIM-SL8

Cable Type	1M	3M	5M	10M
PVC	A01	A02	A05	A10
PU	B01	B02	B05	B10

* Design and specification are subject to change without notice.



M12 I Style (Metal)

Field Installable > Female / Male Connector (Housing)

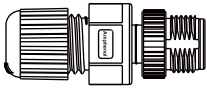

IP 67 . 68 9

Receptacle | Unmated
Overmolded with Cable | Mated
Field Installable | Mated

∟ **M12 I (Metal) > Field Installable>Male Connector (Housing) > Straight (Male+Female Contact)**

		
Type	Contact Type	5 Contacts
Without Strain Relief	Solder Type	12P-05BMIA-SL8001

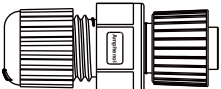
∟ **M12 I (Plastic) > Field Installable > Female Connector (Housing) > Straight (Male+Female Contact)**

		
Type	Contact Type	5 Contacts
Without Strain Relief	Solder Type	12P-05BFIA-SL8001

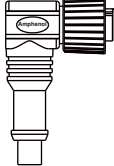
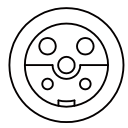

∟ **M12 I (Plastic) > Overmolded with cable > Female Connector (Housing) > Right Angle (Male+Female Contact)**

	
Type	5 Contacts
Without Strain Relief	12P-05BFIM-SR8

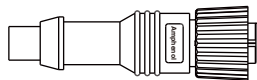
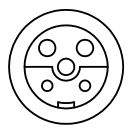
∟ **M12 I (Plastic) > Overmolded with cable > Female Connector (Housing) > Straight (Male+Female Contact)**

	
Type	5 Contacts
Without Strain Relief	12P-05BFIM-SL8

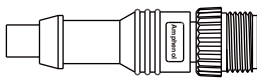
∟ **M12 I (Plastic) > Overmolded with cable > Male Connector (Housing) > Straight (Male+Female Contact)**

	
Type	5 Contacts
Without Strain Relief	12P-05BMIM-SL8

∟ **M12 I (Plastic) > Overmolded with cable > Male Connector (Housing) > Right Angle (Male+Female Contact)**

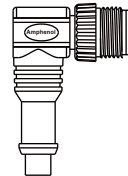
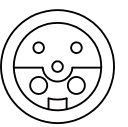
	
Type	5 Contacts
Without Strain Relief	12P-05BMIM-SR8

Cable Type	1M	3M	5M	10M
PVC	A01	A02	A05	A10
PU	B01	B02	B05	B10

* Design and specification are subject to change without notice.

M23 Style (Metal)

Receptacle (Field Installable Type) > Male Connector (Housing)



Field Installable > Female Connector (Housing)

Receptacle | Unmated
Overmolded with Cable | Mated
Field Installable | Mated

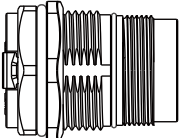
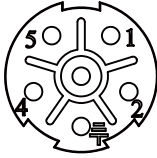
➤ **M23 (Metal) > Receptacle (Field Installable Type) > Male Connector (Housing) > Front Fastened**

		
Backshell: Hexagonal		
Type	Contact Gender	6 Contacts
Crimp Pin	Male	LJ23-06PMMC-SF7001

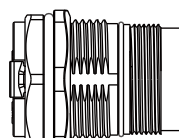

➤ **M23 (Metal) > Receptacle (Field Installable Type) > Male Connector (Housing) > Front Fastened**

		
Backshell: Hexagonal		
Type	Contact Gender	6 Contacts
Crimp Pin	Female	LJ23-06PMFC-SF7001

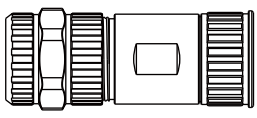
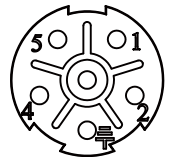



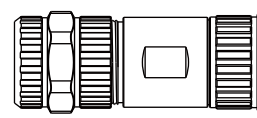

➤ **M23 (Metal) > Field Installable > Female Connector (Housing) > Straight**

			
Type	Contact Type	Contact Gender	6 Contacts
Without Strain Relief	Crimp Pin	Male	LJ23-06DFMC-SL7001

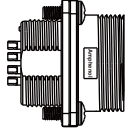

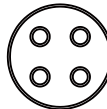
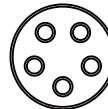
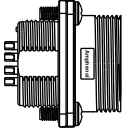
➤ **M23 (Metal) > Field Installable > Female Connector (Housing) > Straight**

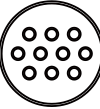
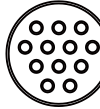
			
Type	Contact Type	Contact Gender	6 Contacts
Without Strain Relief	Crimp Pin	Female	LJ23-06DFFC-SL7001 LJ23-06DFFC-SL7002

∟ Heavy Duty Shielded Connector (Metal) > Receptacle > Male Connector (Housing) > Front Fastened

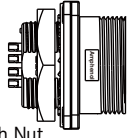

 <p>Backshell: Square Mating style: Screw Thread Mounting Thread: M3*4 pics</p>						
Current Rating	Contact Type	Salt Spray Test	2 Contacts	3 Contacts	4 Contacts	5 Contacts
10A	PCB Pin (180°) / Female	48H	-	-	LB20-04PMFS-SW8001	LB20-05PMFS-SW8001
		500H	-	-	HB20-04PMFS-SW8001	HB20-05PMFS-SW8001
20A	PCB Pin (180°) / Female	48H	LC20-02PMFS-SW8001	LC20-03PMFS-SW8001	-	-
		500H	HC20-02PMFS-SW8001	HC20-03PMFS-SW8001	-	-
 <p>Backshell: Square Mating style: Screw Thread Mounting Thread: M3*4 pics</p>						
Current Rating	Contact Type	Salt Spray Test	7 Contacts	10 Contacts	12 Contacts	14 Contacts
5A	PCB Pin (180°) / Female	48H	-	LD20-10PMFS-SW8001	LD20-12PMFS-SW8001	LD20-14PMFS-SW8001
		500H	-	HD20-10PMFS-SW8001	HD20-12PMFS-SW8001	HD20-14PMFS-SW8001
10A	PCB Pin (180°) / Female	48H	LB20-07PMFS-SW8001	-	-	-
		500H	HB20-07PMFS-SW8001	-	-	-

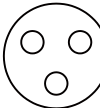
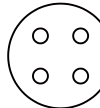
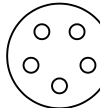
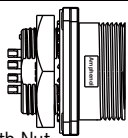
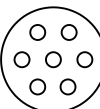
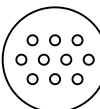
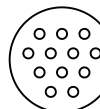
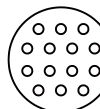
∟ Heavy Duty Shielded Connector (Metal) > Receptacle > Male Connector (Housing) > Rear Fastened

 <p>Backshell: Square Mating style: Screw Thread With Nut Mounting Thread: M20</p>						
Current Rating	Contact Type	Salt Spray Test	2 Contacts	3 Contacts	4 Contacts	5 Contacts
10A	PCB Pin (180°) / Female	48H	-	-	LB20-04PMFS-SN8001	LB20-05PMFS-SN8001
		500H	-	-	HB20-04PMFS-SN8001	HB20-05PMFS-SN8001
20A	PCB Pin (180°) / Female	48H	LC20-02PMFS-SN8001	LC20-03PMFS-SN8001	-	-
		500H	HC20-02PMFS-SN8001	HC20-03PMFS-SN8001	-	-
 <p>Backshell: Square Mating style: Screw Thread With Nut Mounting Thread: M20</p>						
Current Rating	Contact Type	Salt Spray Test	7 Contacts	10 Contacts	12 Contacts	14 Contacts
5A	PCB Pin (180°) / Female	48H	-	LD20-10PMFS-SN8001	LD20-12PMFS-SN8001	LD20-14PMFS-SN8001
		500H	-	HD20-10PMFS-SN8001	HD20-12PMFS-SN8001	HD20-14PMFS-SN8001
10A	PCB Pin (180°) / Female	48H	LB20-07PMFS-SN8001	-	-	-
		500H	HB20-07PMFS-SN8001	-	-	-

* Design and specification are subject to change without notice.

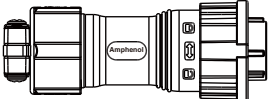
➤ Heavy Duty Shielded Connector (Metal) > Field Installable > Female Connector (Housing) > Straight

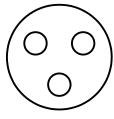
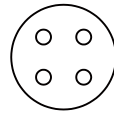
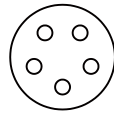
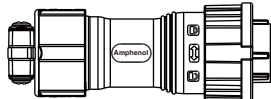
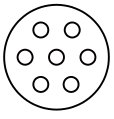
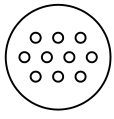
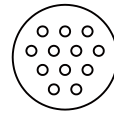
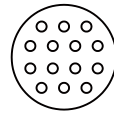
						
Without Strain Relief						
Current Rating	Contact Type	Salt Spray Test	2 Contacts	3 Contacts	4 Contacts	5 Contacts
10A	Solder Type / Male	48H	-	-	LB20-04BFMA-SL8001	LB20-05BFMA-SL8001
		500H	-	-	HB20-04BFMA-SL8001	HB20-05BFMA-SL8001
20A	Solder Type / Male	48H	LC20-02BFMA-SL8001	LC20-03BFMA-SL8001	-	-
		500H	HC20-02BFMA-SL8001	HC20-03BFMA-SL8001	-	-
						
Without Strain Relief						
Current Rating	Contact Type	Salt Spray Test	7 Contacts	10 Contacts	12 Contacts	14 Contacts
5A	Solder Type / Male	48H	-	LD20-10BFMA-SL8001	LD20-12BFMA-SL8001	LD20-14BFMA-SL8001
		500H	-	HD20-10BFMA-SL8001	HD20-12BFMA-SL8001	HD20-14BFMA-SL8001
10A	Solder Type / Male	48H	LB20-07BFMA-SL8001	-	-	-
		500H	HB20-07BFMA-SL8001	-	-	-

USB Connector



Range Overview

Receptacle to Overmolded with Cable

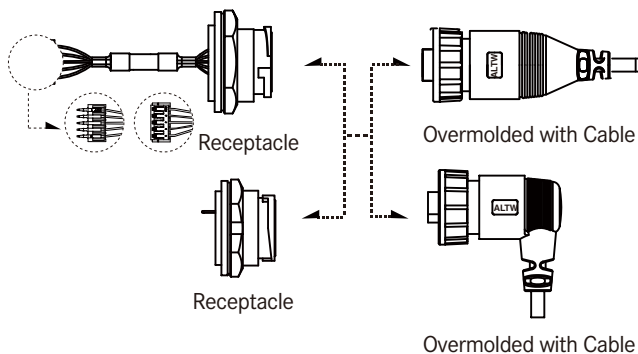

Receptacle with Cable to Overmolded with Cable

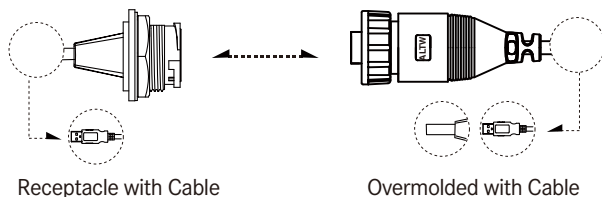

In Line

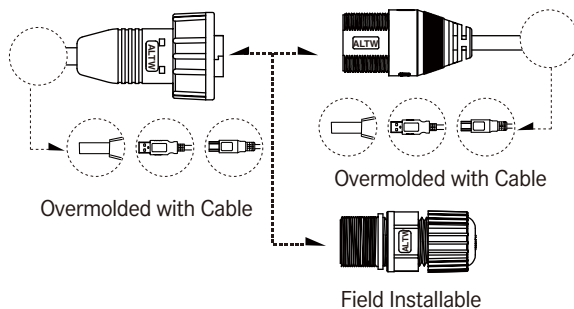

Micro USB



Accessories



Waterproof Cap
See page 21-16



Waterproof Cap
See page 21-16

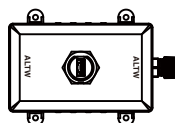

Box
See page 21-21

Specification

Identifications	USB 3.0 A Type USB 2.0 A Type, USB 2.0 B Type Mini USB 2.0 B Type Micro USB: Available soon
Description	Receptacle Receptacle With Cable Overmolded with Cable Field Installable
Current Rating / Data	1.5A
Material	Contacts: Copper Alloy, Gold Plated Connector Body (Housing) : PBT UL94V-0
Waterproof Rating	IP67~68
Temperature Range	Receptacle: Nylon+GF: -40°C~105°C M-PPE: -40°C~105°C ABS: -20°C~80°C Receptacle with cable: Nylon+GF: -20°C~105°C ABS: -20°C~80°C Overmolded with Cable: -20°C~80°C Field Installable: -20°C~80°C
Contact Resistance	≤ 30mΩ
Insulation Resistance	≥ 1000mΩ at DC500V
Breakdown Voltage	≥ AC500V / 1 minute
More to know	USB 2.0: Standard Cable Length: 01-05M USB 3.0: Standard Cable Length: 01-03M Mini USB: Standard Cable Length: 01-04M

* Design and specification are subject to change without notice.

Ordering Information

	1	2	3	4	5	6	7	8	9	10
Specification										
(UA) USB A Type			(NUB) Mini USB B							
(UB) USB B Type										
Data Transfer Rate										
(20) 2.0			(30) 3.0							
Connector Body (Style)										
<u>> For Receptacle</u>			<u>> For Overmolded with Cable</u>							
(P) Front Fastened			(A) With Strain Relief							
<u>> For Field installable</u>			(B) Without Strain Relief							
(B) Without Strain Relief										
Connector (Housing) Gender										
(M) Male			(F) Female							
Contact Gender										
(M) Male (Plug)			(F) Female (Jack)							
Assemble Style										
<u>> For Receptacle</u>			<u>> For Overmolded with Cable</u>							
(P) 180° PCB Type			(M) Overmolded with Cable							
(R) 90° PCB Type			<u>> For Field Installable</u>							
(J) Jack			(A) Field installable (Solder)							
Mating Style										
(S) Screw Thread			(L) 2 Points Lock Bayonet (Nut OD: 28.5mm)							
(N) 2 Points Lock Bayonet (Nut OD: 25.4mm)										
Backshell										
<u>> For Receptacle</u>			<u>> For Overmolded with Cable</u>				<u>> For Field Installable</u>			
(C) Circular			(L) Straight				(L) Straight			
(S) Square			(R) Right Angle							
Waterproof Rating										
(7) IP 67										
(8) IP 68										

More Information

<u>> For Receptacle</u>	<u>> For Overmolded with Cable</u>
(001) Without Cable	(<input type="checkbox"/>)+(<input type="checkbox"/>) : Cable Type + Cable Length
(002) With Cable (Harness (50mm))	EX. (A01) = USB 2.0 Cable + 1M
	<u>(<input type="checkbox"/>) : Cable Type</u> <u>(<input type="checkbox"/>) : Cable Length</u>
(A) USB 2.0 Cable	USB2.0 :From 1M to 5M
(B) USB 3.0 Cable	USB3.0 :From 1M to 3M
	Mini USB2.0: From 1M to 4M
	EX. (01) = 1M

Ordering Information I Double-ended

ALTW waterproof connector to ALTW waterproof connector

ALTW waterproof connector to Standard USB connector (None Waterproof)

	1	2	3	4	5	6	7	8	9
Specification									
(UA) USB A Type									
(UB) USB B Type									
Data Transfer Rate									
(20) 2.0									
(30) 3.0									
Connector Body (Style)									
> For Receptacle									
(P) Front Fastened									
> For Overmolded with Cable									
(A) With Strain Relief									
(B) Without Strain Relief									
Connector (Housing) Gender									
(M) Male									
(F) Female									
Contact Gender									
(M) Male (Plug)									
(F) Female (Jack)									
Mating Style									
(S) Screw Thread									
(L) 2 Points Lock Bayonet (Nut OD: 28.5mm)									
Non-Waterproof (2ne End)									
(A) USB2.0 A Type (Plug)									
(D) USB3.0 A Type (Plug)									
(B) USB2.0 B Type (Plug)									
Waterproof Rating									
(6) IP 66									
(7) IP 67									
(8) IP 68									
More Information									
> For Receptacle with Cable									
(□)+(■) : Cable Type + Cable Length									
EX. (BX10) = USB 3.0 Cable + 100mm									
(□) : Cable Type									
(B) USB 3.0 Cable									
(■) : Cable Length									
USB3.0 :From 100mm to 300mm									
EX. (X10) = 100mm									
> For Overmolded with Cable									
(□)+(■) : Cable Type + Cable Length									
EX. (A01) = USB 2.0 Cable + 1M									
(□) : Cable Type									
(A) USB 2.0 Cable									
(B) USB 3.0 Cable									
(■) : Cable Length									
USB2.0 :From 1M to 5M									
USB3.0 :From 1M to 3M									
Mini USB2.0: From 1M to 4M									
EX. (01) = 1M									

* Design and specification are subject to change without notice.

Physical Dimension

Receptacle

Panel Cut-Out

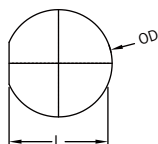

Type		Connector Gender (Housing)	L		OD	
			Male			
USB2.0	Type A	Screw Thread	19.4		20.8	
		2 Points Lock Bayonet	23.6		25.6	
	Type B	Screw Thread	19.4		20.8	
		2 Points Lock Bayonet	23.6		25.6	
USB3.0	Type A	Screw Thread	19.4		20.8	
		2 Points Lock Bayonet	23.6		25.6	
Mini USB	-	Screw Thread	14.8		15.6	

* Maximum Panel Thickness: USB: 4mm I Mini USB: 2.5mm
 * USB: Screw I Middle Size (13/16"-28 UNS)
 2 Points Lock Bayonet I Large Size (1"20 UNEF)
 * Mini USB: Screw I Standard Size (5/8"-27 UNS)

Dimensions are shown in millimeters

Connector Dimension

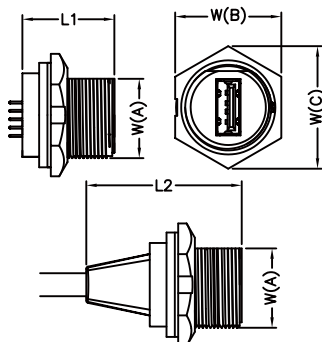

Receptacle with Cable

Type		Connector Gender (Housing)	W(A)	W(B)	W(C)	L1	L2
			Male				
USB2.0	Type A	Screw Thread	19.0	25.4	29.3	22.0	-
		2 Points Lock Bayonet	23.2	28.5	32.9	20.3	-
	Type B	Screw Thread	19.0	25.4	29.3	22.0	-
		2 Points Lock Bayonet	23.2	28.5	32.9	20.3	-
USB3.0	Type A	Screw Thread	19.0	25.4	29.3	-	37.2
		2 Points Lock Bayonet	23.2	28.5	32.9	-	37.5
Mini USB	-	Screw Thread	14.5	20.6	23.5	15.0	-

* USB: Screw I Middle Size (13/16"-28 UNS)
 2 Points Lock Bayonet I Large Size (1"20 UNEF)
 *Mini USB: Screw I Standard Size (5/8"-27 UNS)

Dimensions are shown in millimeters

Overmolded with Cable

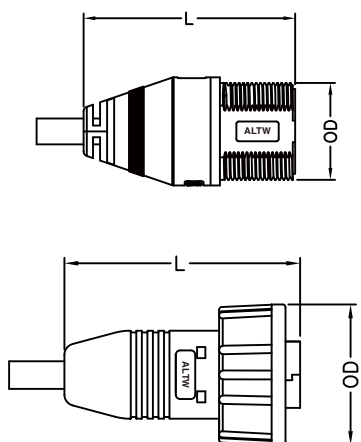

Type		Connector Gender (Housing)	L		OD	
			Female	Male	Female	Male
USB2.0	Type A	Screw Thread	42.6	45.0	25.4	20.6
		2 Points Lock Bayonet	73.3	-	28.5	-
	Type B	Screw Thread	42.6	45.0	25.4	20.6
		2 Points Lock Bayonet	73.3	-	28.5	-
USB3.0	Type A	Screw Thread	42.6	45.0	42.6	20.6
		2 Points Lock Bayonet	75.0	-	28.5	-
Mini USB	-	Screw Thread	42.6	45.0	20.0	15.45

* USB: Screw I Middle Size (13/16"-28 UNS)
 2 Points Lock Bayonet I Large Size (1"20 UNEF)
 *Mini USB: Screw I Standard Size (5/8"-27 UNS)

Dimensions are shown in millimeters

↳ **Overmolded with Cable**

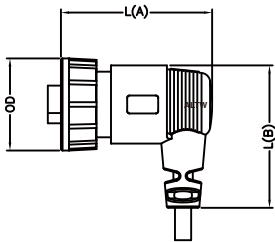

Type	Connector Gender (Housing)	L(A)		L(B)		OD		
		Female	Male	Female	Male	Female	Male	
USB 2.0	Type A	Screw Thread	-	-	-	-	-	-
		2 Points Lock Bayonet	46.8	-	44.1	-	28.5	-
	Type B	Screw Thread	-	-	-	-	-	-
		2 Points Lock Bayonet	46.8	-	44.1	-	28.5	-

* USB: Screw I Middle Size (13/16"-28 UNS) Dimensions are shown in millimeters
 2 Points Lock Bayonet I Large Size (1"20 UNEF)

↳ **Field Installable**

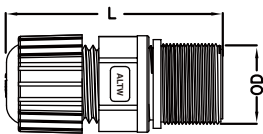

Type	Connector Gender (Housing)	L		OD		
		Female	Male	Female	Male	
USB 2.0	Type A	Screw Thread	-	56.0	-	20.6
		2 Points Lock Bayonet	-	-	-	-
	Type B	Screw Thread	-	56.0	-	20.6
		2 Points Lock Bayonet	-	-	-	-
Mini USB	-	Screw Thread	-	45.0	-	15.45

* USB: Screw I Middle Size (13/16"-28 UNS) Dimensions are shown in millimeters
 2 Points Lock Bayonet I Large Size (1"20 UNEF)
 *Mini USB: Screw I Standard Size (5/8"-27 UNS)

* Design and specification are subject to change without notice.

Product Features

Receptacle

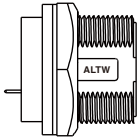

Backshell 8



Circular (C)

Mating Style 7



Screw Thread (S)



2 Points Lock Bayonet (L)
(Nut OD: 28.5mm)

2 Points Lock Bayonet (N)
(Nut OD: 25.4mm)

Connector Body (Style) 3

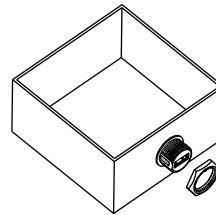

Front Fastened (P)

Overmolded with Cable

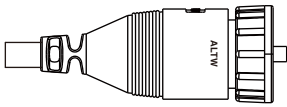

Backshell 8

Straight (L)

Right Angle (R)

Mating Style 7



Screw Thread (S)



2 Points Lock Bayonet (L)
(Nut OD: 28.5mm)

2 Points Lock Bayonet (N)
(Nut OD: 25.4mm)

Connector Body (Style) 3

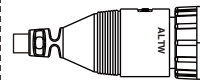

With Strain Relief (A)

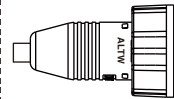

Without Strain Relief (B)

Field Installable

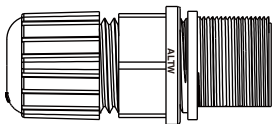

Backshell 8

Straight (L)

Mating Style 7



Screw Thread (S)

Connector Body (Style) 3

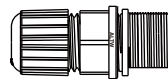

Without Strain Relief (B)

Find Our Standard Products

USB > In-line

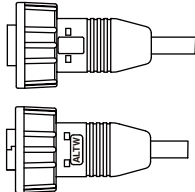
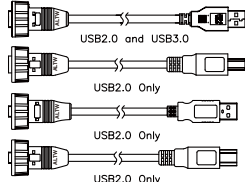
<ul style="list-style-type: none"> • Male Connector (Housing) • Female Contacts • Screw Thread • Middle Size (13/16"-28 UNS) 	<p>Overmolded with Cable-----></p> 	<p>Overmolded with Cable-----></p> 	<p>Overmolded with Cable (Double-Ended)</p>  <p>Non-Waterproof</p>
	<p>** USB 2.0: Choose the cable length from 01~05m ** USB 3.0: Choose the cable length from 01~03m</p>	<p>** USB 2.0: Choose the cable length from 01~05m ** USB 3.0: Choose the cable length from 01~03m</p>	<p>** USB 2.0: Choose the cable length from 01~05m ** USB 3.0: Choose the cable length from 01~03m</p>
Speed (Code)	Male Connector (M) Female Contacts (F)	Female Connector (F) Male Contacts (M)	Female Connector (F) Male Contacts (M)
USB 2.0 Type A	UA-20AMFM-SL7A**	UA-20BFMM-SL7A**	UA-20BFM-SA7A** UA-20BFM-SB7A**
USB 2.0 Type B	UB-20AMFM-SL7A**	UB-20BFMM-SL7A**	UB-20BFM-SA7A** UB-20BFM-SB7A**
USB 3.0 Type A	UA-30AMFM-SL7B**	UA-30BFMM-SL7B**	UA-30BFM-SD7B**

* Refer to P4-4 for ordering information.

USB > In-line

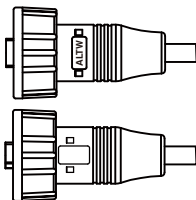
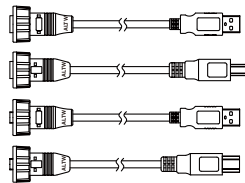
<ul style="list-style-type: none"> • Male Connector (Housing) • Female Contacts • Screw Thread • Middle Size (13/16"-28 UNS) 	<p>Field Installable-----></p> 	<p>Overmolded with Cable-----></p> 	<p>Overmolded with Cable (Double-Ended)</p>  <p>Non-Waterproof</p>
	<p>** USB 2.0: Choose the cable length from 01~05m</p>	<p>** USB 2.0: Choose the cable length from 01~05m</p>	<p>** USB 2.0: Choose the cable length from 01~05m</p>
Speed (Code)	Male Connector (M) Female Contacts (F)	Female Connector (F) Male Contacts (M)	Female Connector (F) Male Contacts (M)
USB 2.0 Type A	UA-20BMFA-SL8001	UA-20BFMM-SL7A**	UA-20BFM-SA7A** UA-20BFM-SB7A**
USB 2.0 Type B	UB-20BMFA-SL8001	UB-20BFMM-SL7A**	UB-20BFM-SA7A** UB-20BFM-SB7A**

* Refer to P4-4 for ordering information.

* Design and specification are subject to change without notice.

➤ **USB > In-line**

<ul style="list-style-type: none"> • Male Connector (Housing) • Female Contacts • Screw Thread • Middle Size (13/16"-28 UNS) 	<p>Overmolded with Cable (Double-Ended)</p> <p>USB2.0 and USB3.0</p> <p>** USB 2.0: Choose the cable length from 01~05m ** USB 3.0: Choose the cable length from 01~03m</p>	<p>Overmolded with Cable (Double-Ended)</p> <p>USB2.0 and USB3.0</p> <p>** USB 2.0: Choose the cable length from 01~05m ** USB 3.0: Choose the cable length from 01~03m</p>	<p>Field Installable</p>												
	<table border="1"> <thead> <tr> <th>Speed (Code)</th> <th>Male Connector (M) Female Contacts (F)</th> <th>Female Connector (F) Male Contacts (M)</th> <th>Female Connector (F) Male Contacts (M)</th> </tr> </thead> <tbody> <tr> <td>USB 2.0 Type A</td> <td>UA-20AMF-SA7A**</td> <td>UA-20BFM-SA7A**</td> <td>-</td> </tr> <tr> <td>USB 3.0 Type A</td> <td>UA-30AMF-SD7B**</td> <td>UA-30BFM-SD7B**</td> <td>-</td> </tr> </tbody> </table>	Speed (Code)	Male Connector (M) Female Contacts (F)	Female Connector (F) Male Contacts (M)	Female Connector (F) Male Contacts (M)	USB 2.0 Type A	UA-20AMF-SA7A**	UA-20BFM-SA7A**	-	USB 3.0 Type A	UA-30AMF-SD7B**	UA-30BFM-SD7B**	-		
Speed (Code)	Male Connector (M) Female Contacts (F)	Female Connector (F) Male Contacts (M)	Female Connector (F) Male Contacts (M)												
USB 2.0 Type A	UA-20AMF-SA7A**	UA-20BFM-SA7A**	-												
USB 3.0 Type A	UA-30AMF-SD7B**	UA-30BFM-SD7B**	-												

* Refer to P4-4 for ordering information.

* Refer to P4-4 for ordering information.

➤ **USB > Receptacle and Mating Pair**

<ul style="list-style-type: none"> • Male Connector (Housing) • Female Contacts • Screw Thread • Middle Size (13/16"-28 UNS) 	<p>Receptacle</p> <p>Type 1 Type 2</p>	<p>Overmolded with Cable</p> <p>** Choose the cable length from 01~05m</p>	<p>Overmolded with Cable (Double-Ended)</p> <p>Non-Waterproof</p> <p>** Choose the cable length from 01~05m</p>												
	<table border="1"> <thead> <tr> <th>Speed (Code)</th> <th>Male Connector (M) Female Contacts (F)</th> <th>Female Connector (F) Male Contacts (M)</th> <th>Female Connector (F) Male Contacts (M)</th> </tr> </thead> <tbody> <tr> <td>USB 2.0 Type A</td> <td>UA-20PMFP-SC8001 UA-20PMFP-SC8002 Type1 UA-20PMFP-SC8003 Type2</td> <td>UA-20BFMM-SL7A**</td> <td>UA-20BFM-SA7A** UA-20BFM-SB7A**</td> </tr> <tr> <td>USB 2.0 Type B</td> <td>UB-20PMFP-SC8001 UB-20PMFP-SC8002 UB-20PMFP-SC8003</td> <td>UB-20BFMM-SL7A**</td> <td>UB-20BFM-SA7A** UB-20BFM-SB7A**</td> </tr> </tbody> </table>	Speed (Code)	Male Connector (M) Female Contacts (F)	Female Connector (F) Male Contacts (M)	Female Connector (F) Male Contacts (M)	USB 2.0 Type A	UA-20PMFP-SC8001 UA-20PMFP-SC8002 Type1 UA-20PMFP-SC8003 Type2	UA-20BFMM-SL7A**	UA-20BFM-SA7A** UA-20BFM-SB7A**	USB 2.0 Type B	UB-20PMFP-SC8001 UB-20PMFP-SC8002 UB-20PMFP-SC8003	UB-20BFMM-SL7A**	UB-20BFM-SA7A** UB-20BFM-SB7A**		
Speed (Code)	Male Connector (M) Female Contacts (F)	Female Connector (F) Male Contacts (M)	Female Connector (F) Male Contacts (M)												
USB 2.0 Type A	UA-20PMFP-SC8001 UA-20PMFP-SC8002 Type1 UA-20PMFP-SC8003 Type2	UA-20BFMM-SL7A**	UA-20BFM-SA7A** UA-20BFM-SB7A**												
USB 2.0 Type B	UB-20PMFP-SC8001 UB-20PMFP-SC8002 UB-20PMFP-SC8003	UB-20BFMM-SL7A**	UB-20BFM-SA7A** UB-20BFM-SB7A**												

* Refer to P4-4 for ordering information.

↳ USB > Receptacle and Mating Pair

<ul style="list-style-type: none"> • Male Connector (Housing) • Female Contacts • 2 Points Lock Bayonet (Nut OD: 28.5mm) • Large Size (1"20 UNEF) 	<p>Receptacle</p> <p>Type 1 Type 2</p>	<p>Overmolded with Cable</p> <p>** Choose the cable length from 01~05m</p>	<p>Field Installable</p>
	<p>Speed (Code)</p> <p>Male Connector (M) Female Contacts (F)</p>	<p>Female Connector (F) Male Contacts (M)</p>	<p>Female Connector (F) Male Contacts (M)</p>
<p>USB 2.0 Type A</p>	<p>UA-20PMFP-LC7001 UA-20PMFP-LC7002 <small>Type1</small> UA-20PMFP-LC7003 <small>Type2</small></p>	<p>UA-20AFMM-LL7A** UA-20AFMM-LR7A**</p>	<p>-</p>
<p>USB 2.0 Type B</p>	<p>UB-20PMFP-LC7001 UB-20PMFP-LC7002 UB-20PMFP-LC7003</p>	<p>UB-20AFMM-LL7A** UB-20AFMM-LR7A**</p>	<p>-</p>

↳ USB > Receptacle and Mating Pair

<ul style="list-style-type: none"> • Male Connector (Housing) • Female Contacts • 2 Points Lock Bayonet (Nut OD: 25.4mm) • Large Size (1"20 UNEF) 	<p>Receptacle</p>	<p>Overmolded with Cable</p> <p>** Choose the cable length from 01~05m</p>	<p>Field Installable</p>
	<p>Speed (Code)</p> <p>Male Connector (M) Female Contacts (F)</p>	<p>Female Connector (F) Male Contacts (M)</p>	<p>Female Connector (F) Male Contacts (M)</p>
<p>USB 2.0 Type A</p>	<p>UA-20PMFJ-NC7001</p>	<p>UA-20BFMM-NL7A**</p>	<p>-</p>

USB

Receptacle with Overmolded Cable and Mating Pair
 2 Points Lock Bayonet
 Large Size

➤ **USB > Receptacle with Overmolded Cable and Mating Pair**

<ul style="list-style-type: none"> • Male Connector (Housing) • Female Contacts • Screw Thread • 2 Points Lock Bayonet (Nut OD: 28.5mm) • Large Size (1"20 UNEF) 	<p>Receptacle with Cable (Double-Ended)</p> <p>Non-Waterproof</p> <p>** USB 3.0: Choose the cable length from 100~300mm</p>	<p>Overmolded with Cable</p>	<p>Overmolded with Cable (Double-Ended)</p> <p>** USB 3.0: Choose the cable length from 01~03m</p>
	<p>Speed (Code)</p> <p>Male Connector (M) Female Contacts (F)</p>	<p>Female Connector (F) Male Contacts (M)</p>	<p>Female Connector (F) Male Contacts (M)</p>
<p>USB 3.0 Type A</p>	<p>UA-30PMF-LD7B** UA-30PMF-SD7B**</p>	<p>UA-30AFMM-LL7BXX UA-30BFMM-SL7BXX</p>	<p>UA-30BFM-SD7B** UA-30AFM-LD7A**</p>

* Refer to P4-4 for ordering information.

* Refer to P4-4 for ordering information.

↳ **Mini USB > In-line**

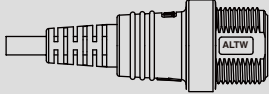
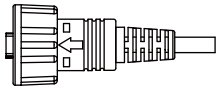
<ul style="list-style-type: none"> • Male Connector (Housing) • Female Contacts • Screw Thread • Standard Size (5/8"-27 UNS) 	<p>Overmolded with Cable-----></p>  <p>** Choose the cable length from 01~04m</p>	<p>Overmolded with Cable</p>  <p>** Choose the cable length from 01~04m</p>	<p>Field Installable</p>
	Speed (Code)	Male Connector (M) Female Contacts (F)	Female Connector (F) Male Contacts (M)
Mini USB 2.0 Type B	NUB-20AMFM-SL7A**	NUB-20AFMM-SL7A**	-

↳ **Mini USB > In-line**

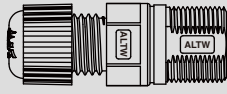
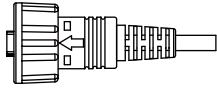
<ul style="list-style-type: none"> • Male Connector (Housing) • Female Contacts • Screw Thread • Standard Size (5/8"-27 UNS) 	<p>Field Installable -----></p>  <p>** Choose the cable length from 01~04m</p>	<p>Overmolded with Cable</p>  <p>** Choose the cable length from 01~04m</p>	<p>Field Installable</p>
	Speed (Code)	Male Connector (M) Female Contacts (F)	Female Connector (F) Male Contacts (M)
Mini USB 2.0 Type B	NUB-20AMFM-SL7A**	NUB-20AFMM-SL7A**	-

↳ **Mini USB > Receptacle and Mating Pair**

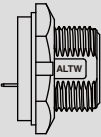
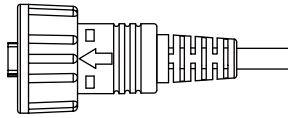
<ul style="list-style-type: none"> • Male Connector (Housing) • Female Contacts • Screw Thread • Standard Size (5/8"-27 UNS) 	<p>Receptacle -----></p> 	<p>Overmolded with Cable</p>  <p>** Choose the cable length from 01~04m</p>	<p>Field Installable</p>
	Speed (Code)	Male Connector (M) Female Contacts (F)	Female Connector (F) Male Contacts (M)
Mini USB 2.0 Type B	NUB-20PMFP-SC7001 NUB-20PMFR-SC7001	NUB-20AFMM-SL7A**	-

IEEE 1394 Connector



Range Overview

Receptacle to Overmolded with Cable

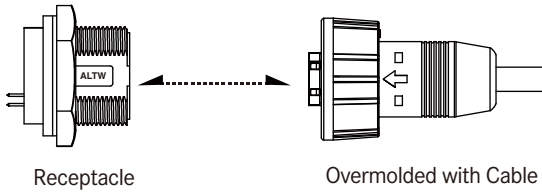

In Line

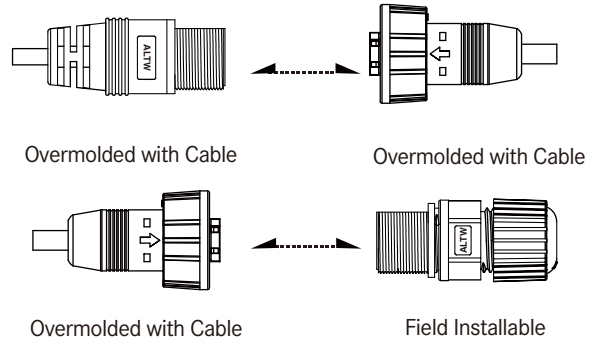

Accessories

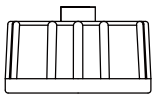

Waterproof Cap
See page 21-16

Specification

Identifications	IEEE 1394
Description	Receptacle Overmolded with Cable Field Installable
Current Rating / Data	1A
Material	Contacts: Copper Alloy, Gold Plated Connector Body (Housing) : PBT UL94V-0
Waterproof Rating	IP67~68
Temperature Range	Receptacle: -20°C~80°C Overmolded with Cable: -20°C~80°C Field Installable: -20°C~80°C
Contact Resistance	≤ 30mΩ Max
Insulation Resistance	≥ 100MΩ at DC500V
Durability	500 cycles
Breakdown Voltage	≥ AC 500V / 1 minute
More to know	Standard Cable Length: 01~04M

* Design and specification are subject to change without notice.

Ordering Information

1 — 2 3 4 5 6 — 7 8 9 10

Specification

(13) 1394 Connector

Type

(AA) 1394A

Connector Body (Style)

> For Receptacle

(P) Front Fastened

> For Field installable

(B) Without Strain Relief

> For Overmolded with Cable

(A) With Strain Relief

(B) Without Strain Relief

Connector (Housing) Gender

(M) Male Connector

(F) Female Connector

Contact Gender

(M) Male (Plug)

(F) Female (Jack)

Assemble Style

> For Receptacle

(P) 180° PCB Type

> For Overmolded with Cable

(M) Overmolded with Cable

> For Field Installable

(A) Field installable (Solder)

Mating Style

(S) Screw Thread

Backshell

> For Receptacle

(C) Circular

> For Field Installable

(L) Straight

> For Overmolded with Cable

(L) Straight

Waterproof Rating

(7) IP 67

(8) IP 68

More Information

> For Receptacle

(001) Without Cable

 (002) With Cable (Harness
 (50mm))

> For Overmolded with Cable

(□)+(■) : Cable Type + Cable Length

EX. (A01) = 1394A Cable + 1M

(□) : Cable Type

(A) 1394A Cable

(■) : Cable Length

From 1M to 4M

EX. (01) = 1M

Physical Dimension

Receptacle

Panel Cut-Out Connector Dimension

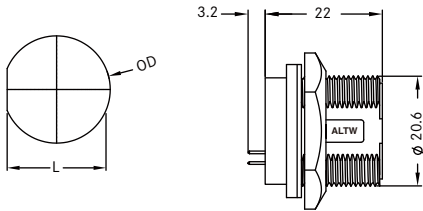

Type \ Dimension	L		OD	
Connector Gender	Male			
IEEE 1394	19.4		20.8	

* Maximum Panel Thickness: 4mm

Dimensions are shown in millimeters

Overmolded with Cable

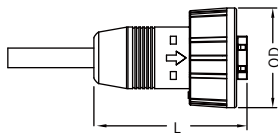

with Strain Relief / Straight

Type \ Dimension	L		OD	
Connector Gender	Female	Male	Female	Male
IEEE 1394	42.6	55.0	25.4	20.6

Dimensions are shown in millimeters

Field Installable

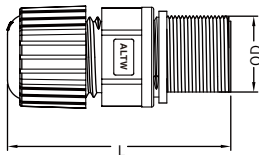

without Strain Relief / Straight

Type \ Dimension	L		OD	
Connector Gender	Female	Male	Female	Male
IEEE 1394	-	56.0	-	20.6

Dimensions are shown in millimeters

Contact Configuration

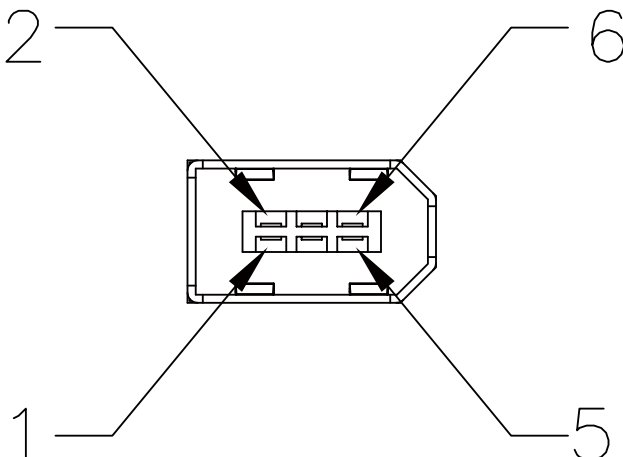

* Design and specification are subject to change without notice.

Product Features

Receptacle

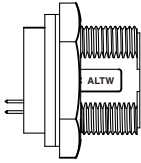

* PCB Pin 180°

Backshell 8



Circular (C)

Mating Style 7



Screw Thread (S)

Connector Body(Style) 3

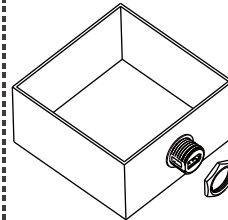

Front Fastened (P)

Overmolded with Cable

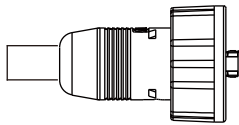

Backshell 8

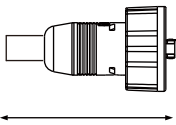

Straight (L)

Mating Style 7



Screw Thread (S)

Connector Body(Style) 3

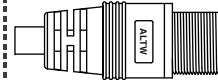

With Strain Relief (A)

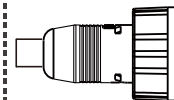

Without Strain Relief (B)

Field Installable

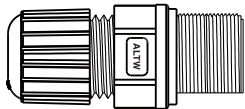

Backshell 8

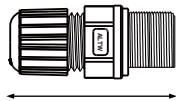

Straight (L)

Mating Style 7



Screw Thread (S)

Connector Body(Style) 3



Without Strain Relief (B)

Find Our Standard Products

↳ In-line

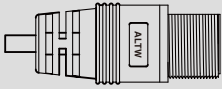
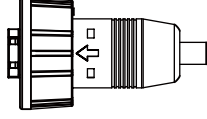
<ul style="list-style-type: none"> • Male Connector (Housing) • Female Contacts • Screw Thread 	Overmolded with Cable → 	Overmolded with Cable → 	Field Installable
	** Choose the cable length from 01~04m		** Choose the cable length from 01~04m
Code	Male Connector (M) Female Contacts (F)	Female Connector (F) Male Contacts (M)	Female Connector (F) Male Contacts (M)
IEEE 1394 A Type (13)	13-AAAMFM-SL7A**	13-AABFMM-SL7A**	-

↳ In-line

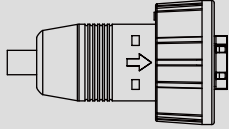
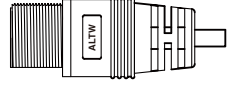
<ul style="list-style-type: none"> • Female Connector (Housing) • Male Contacts • Screw Thread 	Overmolded with Cable → 	Overmolded with Cable → 	Field Installable
	** Choose the cable length from 01~04m		** Choose the cable length from 01~04m
Code	Female Connector (F) Male Contacts (M)	Male Connector (M) Female Contacts (F)	Male Connector (M) Female Contacts (F)
IEEE 1394 A Type (13)	13-AABFMM-SL7A**	13-AAAMFM-SL7A**	13-AABMFA-SL8001

↳ Receptacle and Mating Pair

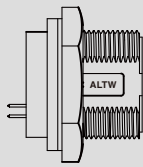
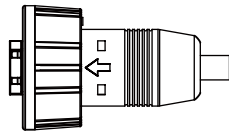
<ul style="list-style-type: none"> • Male Connector (Housing) • Female Contacts • Screw Thread 	Receptacle → 	Overmolded with Cable → 	Field Installable
			** Choose the cable length from 01~04m
Code	Male Connector (M) Female Contacts (F)	Female Connector (F) Male Contacts (M)	Female Connector (F) Male Contacts (M)
IEEE 1394 A Type (13)	13-AAPMFP-SC8001	13-AABFMM-SL7A**	-

* Design and specification are subject to change without notice.

D-Sub Connector



Range Overview

Receptacle to Overmolded with Cable

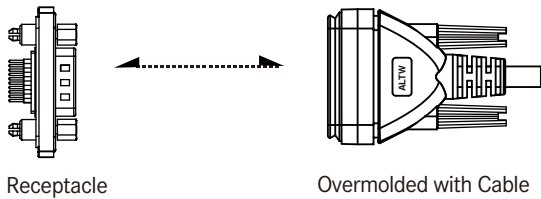

Receptacle to Field Installable

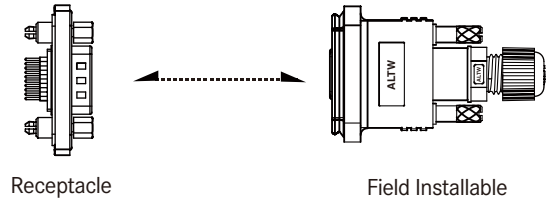

Accessories

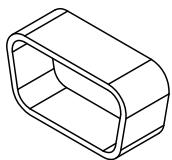

Dust Cap
See page 21-10

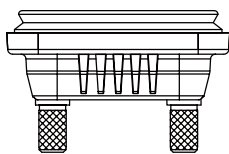

Waterproof Cap
See page 21-16

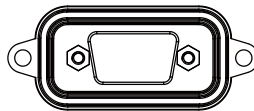

Joint
See page 21-23

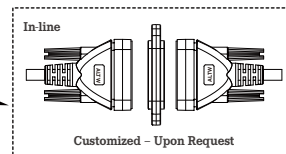

Specification

Identifications	Standard D-Sub Connector High Density D-Sub Connector
Description	Receptacle Overmolded with Cable Field Installable
Current Rating / Data	Standard D-Sub : 5A High Density D-Sub : 2A
Material	Contacts: Copper Alloy, Gold Plated Connector Body (Housing) : Nylon 9T or PBT, UL Recognized Shell: Steel, Nickel Plated
Waterproof Rating	Receptacle: IP68 Overmolded with Cable: IP67 Field Installable: IP67
Temperature Range	Receptacle: -20°C~105°C Overmolded with Cable: -20°C~80°C Field Installable: -20°C~105°C
Contact Resistance	≤ 20mΩ
Insulation Resistance	≥ 500mΩ at DC500V
Durability	500 cycles
Breakdown Voltage	≥ AC500V / 1 minute
More to know	Standard Cable Length: 01~99M

* Design and specification are subject to change without notice.

Ordering Information

1	2	3	4	5	6	7	8	9	10
Specification > Standard (SDB) D-SUB > High Density (HDB) High Density D-SUB									
Number of Contacts 09,15,,25,26...78 Contacts Ex. 09 Pin = (09)									
Connector Body (Style) > For Receptacle (P) Front Fastened > For Overmolded with Cable (A) With Strain Relief > For Field installable (B) Without Strain Relief									
Connector (Housing) Gender (M) Male (F) Female									
Contact Gender (M) Male (Plug) (F) Female (Jack)									
Assemble Style > For Receptacle (S) Solder Type (P) PCB Type (90° / 180°) > For Overmolded with Cable (M) Overmolded with Cable > For Field Installable (A) Field Installable (Solder) (C) Field Installable (Crimped)									
Mating Style (S) Screw Thread (Q) Automated Latch									
Backshell > For Receptacle (With Board Lock) (A) Straight (B) Right Angle (Without Board Lock) (L) Straight (R) Right Angle > For Overmolded with Cable (Without Board Lock) (L) Straight > For Field Installable (Without Board Lock) (L) Straight									
Waterproof Rating (7) IP 67 (8) IP 68									
More Information > For Receptacle (001), (002)..... Without Cable : Different Versions > For Overmolded with Cable (□)+(■) : Cable Type + Cable Length EX. (A01) = UL2464 Cable + 1M (□) : Cable Type (A) UL2464 Cable (■) : Cable Length From 1M to 99M EX. (01) = 1M									

Physical Dimension

Receptacle

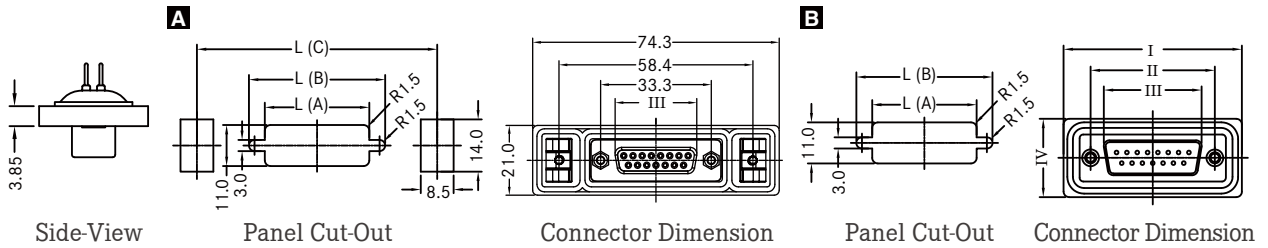

Current Rating		Dimension		Type	L (A)	L (B)	L (C)	I	II	III		IV
Connector	Current Rating	Number of Contacts	Female / Male					Female	Male	Female	Male	Female / Male
Standard D-SUB	5A	9Pins	B	20.0	28.2	-	39.4	25.0	16.33	16.92	21.0	-
		15Pins	A	28.0	36.5	58.4	-	-	24.66	25.25	-	-
			B	28.0	36.5	-	47.8	33.3	24.66	25.25	21.0	-
		25Pins	B	41.5	51.0	-	64.5	47.04	38.38	38.96	21.0	-
		37Pins	B	57.9	67.8	-	78.4	63.5	54.8	55.4	21.3	-
High Density D-SUB	2A	50Pins	B	55.5	65.0	-	75.9	61.1	52.25	52.81	23.9	-
		15Pins	B	20.2	28.2	-	39.4	25.0	16.33	16.92	21.0	-
		26Pins	A	28.0	36.5	58.4	-	-	24.66	25.25	-	-
			B	28.0	36.5	-	47.8	33.3	24.66	25.25	21.0	-
		44Pins	B	41.5	51.0	-	64.5	47.04	38.38	38.96	21.0	-
62Pins	B	57.9	67.8	-	78.4	63.5	54.8	55.4	21.3	-		
78Pins	B	55.5	65.0	-	75.9	61.1	52.25	52.81	23.9	-		

* Maximum Panel Thickness: 2mm

Overmolded with Cable

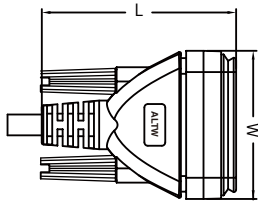

With Strain Relief / Straight

Current Rating		Dimension		L	W
Connector	Current Rating	Number of Contacts	Female / Male	Female / Male	Female / Male
Standard D-SUB	5A	9	55.9	42.4	-
		15	53.5	50.6	-
		25	60.0	64.5	-
		37	69.3	81.1	-
		50	71.8	79.3	-
High Density D-SUB	2A	15	55.9	42.4	-
		26	53.5	50.6	-
		44	60.0	64.5	-
		62	69.3	81.1	-
		78	71.8	79.3	-

Dimensions are shown in millimeters

Field Installable

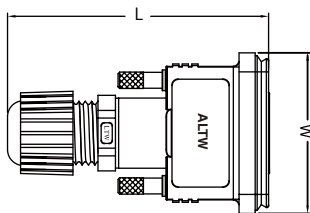











Without Strain Relief / Straight

Current Rating		Dimension		L	W
Connector	Current Rating	Number of Contacts	Female / Male	Female / Male	Female / Male
Standard D-SUB	5A	9	66.8	42.8	-
		15	63.0	50.7	-
		25	81.6	50.6	-
		37	91.9	64.4	-
High Density D-SUB	2A	15	66.8	42.8	-
		26	63.0	50.7	-
		44	81.6	50.6	-
			91.9	64.4	-

Dimensions are shown in millimeters

* Design and specification are subject to change without notice.

Contact Configuration

	Standard D-SUB (5A)	High Density D-SUB (2A)
9Pin (09)	 R C F	
15Pin (15)	 R C F	 R C F
25Pin (25)	 R C F	
26Pin (26)		 R C F
37Pin (37)	 R C	
44Pin (44)		 R C F
50Pin (50)	 R C	
62Pin (62)		 R C
78Pin (78)		 R C

R: Receptacle
C: Overmolded with Cable
F: Field Installable



▲ 2A (HDB) 1
● 5A (SDB)

Number of Contacts : 2
Ex.2 contacts (02)

Connector (Housing) Gender: 4
Male(M) or Female(F)

Contact Gender: 5
Male(M) or Female(F)

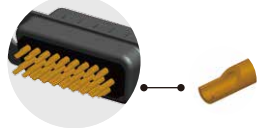
More to Choose: 6

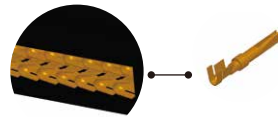
- Solder (S)
- Solder Contact

- PCB Type (P)
- 90° PCB - 180° PCB
 
- Crimp type (C)

Product Features

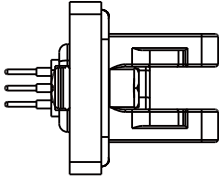
Receptacle

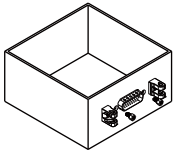

Connector Body(Style) 3



Front Fastened (P)

Mating Style 7

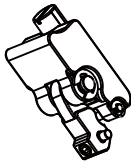

Automated Latch (Q)



Screw Thread (S)

Backshell 8

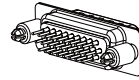

(With Board Lock)
Straight (A)

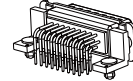

Right Angle (B)

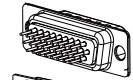

(Without Board Lock)
Straight (L)



Right Angle (R)

Overmolded with Cable

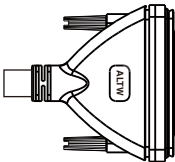

Mating Style 7



Screw Thread (S)

Connector Body(Style) 3

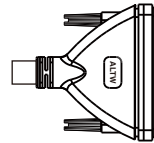

With Strain Relief (A)

Backshell 8

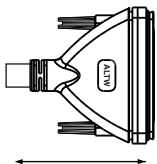

Straight (L)

Field Installable

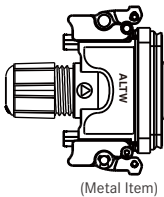

(Metal Item)

Mating Style 7

(Metal Item)

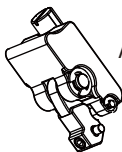

Automated Latch (Q)

Connector Body(Style) 3

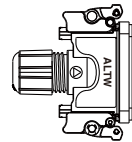

Without Strain Relief (B)

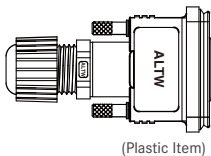

(Plastic Item)

Mating Style 7

(Plastic Item)



Screw Thread (S)

Backshell 8

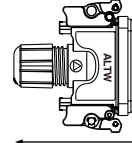

Straight (L)

* Design and specification are subject to change without notice.

Find Our Standard Products

Receptacle and Mating Pair

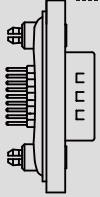
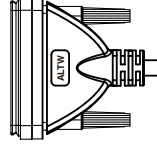
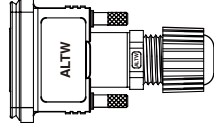
<ul style="list-style-type: none"> • Male Connector (Housing) • Male Contacts • Screw Thread • Plastic Connectors 		 <p>Receptacle</p>	 <p>Overmolded with Cable</p>	 <p>Field Installable</p>
Current Rating (Code)	Contacts 2	Male Connector (M) Male Contacts (M)	Female Connector (F) Female Contacts (F)	Female Connector (F) Female Contacts (F)
Standard D-SUB 5A (SDB)	09, 15, 25, 37, 50	SDB- 2 PMMP-SA800 1 SDB- 2 PMMP-SB800 1 SDB- 2 PMMP-SL800 1 SDB- 2 PMMP-SR800 1 SDB- 2 PMMS-SL800 1	SDB- 2 AFFM-SL7A**	SDB- 2 BFFA-SL700 1 SDB- 2 BFFC-SL700 1
High Density D-SUB 2A (HDB)	15, 26, 44, 62, 78	HDB- 2 PMMP-SA800 1 HDB- 2 PMMP-SB800 1 HDB- 2 PMMP-SL800 1 HDB- 2 PMMP-SR800 1 HDB- 2 PMMS-SL800 1	HDB- 2 AFFM-SL7A**	HDB- 2 BFFA-SL700 1
		- PCB 180° with Board Lock : 5A (SDB) 09 / 15 / 25 / 37 pins. 2A (HDB) 15 / 26 / 44 / 62 pins. - PCB 90° with Board Lock: 5A (SDB) 09 / 15 pins. 2A (HDB) 15 / 26 pins. - Solder Type: 5A (SDB) 09 / 15 / 25 / 37 / 50 pins. 2A (HDB) 15 / 26 / 44 / 62 / 78 pins.	-	- Crimp Pin: 5A (SDB) 09 / 15 / 25 pins. - Solder Pin: 5A (SDB) 09 / 15 / 25 pins. 2A (HDB) 15 / 26 / 44 pins.

**Choose the cable length: 01-99m

▾ Receptacle and Mating Pair

<ul style="list-style-type: none"> • Female Connector (Housing) • Female Contacts • Screw Thread • Plastic Connectors 		Receptacle	Overmolded with Cable	Field Installable
Current Rating (Code)	Contacts 2	Female Connector (F) Female Contacts (F)	Male Connector (M) Male Contacts (M)	Male Connector (M) Male Contacts (M)
Standard D-SUB 5A (SDB)	09, 15, 25, 37, 50	SDB- 2 PFFP-SA800 1 SDB- 2 PFFP-SB800 1 SDB- 2 PFFP-SL800 1 SDB- 2 PFFP-SR800 1 SDB- 2 PFFS-SL800 1	SDB- 2 AMMM-SL7A**	SDB- 2 BMMA-SL700 1 SDB- 2 BMMC-SL700 1
High Density D-SUB 2A (HDB)	15, 26, 44, 62, 78	HDB- 2 PFFP-SA800 1 HDB- 2 PFFP-SB800 1 HDB- 2 PFFP-SL800 1 HDB- 2 PFFP-SR800 1 HDB- 2 PFFS-SL800 1	HDB- 2 AMMM-SL7A**	HDB- 2 BMMA-SL700 1
		- PCB 180° with Board Lock : 5A (SDB) 09 / 15 / 25 / 37 pins. 2A (HDB) 15 / 26 / 44 / 62 pins. - PCB 90° with Board Lock: 5A (SDB) 09 / 15 pins. 2A (HDB) 15 / 26 pins. - Solder Type: 5A (SDB) 09 / 15 / 25 / 37 / 50 pins. 2A (HDB) 15 / 26 / 44 / 62 / 78 pins.	-	- Crimp Pin: 5A (SDB) 09 / 15 / 25 pins. - Solder Pin: 5A (SDB) 09 / 15 / 25 pins. 2A (HDB) 15 / 26 / 44 pins.

**Choose the cable length: 01-99m

* Design and specification are subject to change without notice.

∟ Receptacle and Mating Pair

<ul style="list-style-type: none"> • Male Connector (Housing) • Male Contacts • Automated Latch • Metal Connectors 		Receptacle	Overmolded with Cable	Field Installable
Current Rating (Code)	Contacts	Male Connector (M) Male Contacts (M)	Female Connector (F) Female Contacts (F)	Female Connector (F) Female Contacts (F)
Standard D-SUB 5A (SDB)	15	SDB-15PMMP-QA8001 SDB-15PMMP-QB8001 SDB-15PMMP-QL8001 SDB-15PMMS-QL8001	-	SDB-15BFFA-QL7001
High Density D-SUB 2A (HDB)	26	HDB-26PMMP-QA8001 HDB-26PMMP-QB8001 HDB-26PMMP-QL8001 HDB-26PMMS-QL8001	-	HDB-26BFFA-QL7001

∟ Receptacle and Mating Pair

<ul style="list-style-type: none"> • Female Connector (Housing) • Female Contacts • Automated Latch • Metal Connectors 		Receptacle	Overmolded with Cable	Field Installable
Current Rating (Code)	Contacts	Female Connector (F) Female Contacts (F)	Male Connector (M) Male Contacts (M)	Male Connector (M) Male Contacts (M)
Standard D-SUB 5A (SDB)	15	SDB-15PFFP-QA8001 SDB-15PFFP-QB8001 SDB-15PFFP-QL8001 SDB-15PFFS-QL8001	-	SDB-15BMMA-QL7001
High Density D-SUB 2A (HDB)	26	HDB-26PFFP-QA8001 HDB-26PFFP-QB8001 HDB-26PFFP-QL8001 HDB-26PFFS-QL8001	-	HDB-26BMMA-QL7001

DVI Connector



Range Overview

∟ Receptacle to Overmolded with Cable

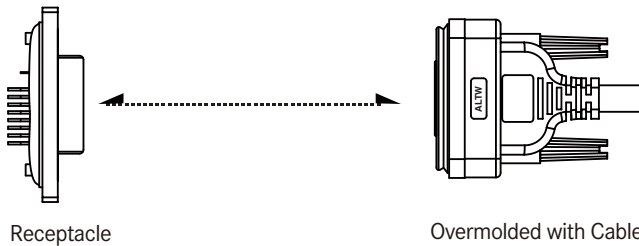

Receptacle

Overmolded with Cable

∟ Accessories

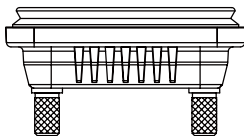

Waterproof Cap
See page 21-16

Specification

Identifications	DVI-D Single Link (DDS): Digital DVI-D Dual Link (DDD): Digital DVI-I Single Link (DIS): Digital and Analog DVI-I Dual Link (DID): Digital and Analog
Description	Receptacle Overmolded with Cable
Current Rating / Data	1.5A
Material	Contacts: Cooper Alloy, Gold Plated Connector Body (Housing): Nylon + GF, UL Recognized Shell: Steel, Nickel Plated
Waterproof Rating	Receptacle: IP68 Overmolded with Cable: IP67
Temperature Range	Receptacle: -20°C~80°C Overmolded with Cable: -20°C~80°C
Contact Resistance	≤ 20mΩ
Insulation Resistance	≥ 1000mΩ at DC500V
Durability	100 cycles
Breakdown Voltage	≥ AC 500V / 1 minute
More to know	Standard Cable Length: 01~05M

* Design and specification are subject to change without notice.

Physical Dimension

Receptacle

Panel Cut-Out

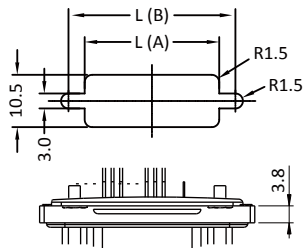

Connector Dimension

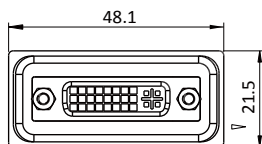

* This only shows the actual dimension, and the actual product may differ

Type	Dimension	L(A)	L(B)
Connector Gender		Male	
DVI-D Single Link(DDS)		27.00	33.50
DVI-D Dual Link(DDD)		27.00	33.50
DVI-I Single Link(DIS)		27.00	33.50
DVI-I Dual Link(DID)		27.00	33.50

* Maximum Panel Thickness: 2mm

Dimensions are shown in millimeters

Overmolded with Cable

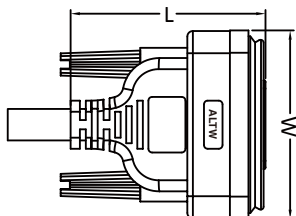

Type	Dimension	L	W
Connector Gender		Male	
DVI-D Single Link(DDS)		52.60	50.90
DVI-D Dual Link(DDD)		52.60	50.90
DVI-I Single Link(DIS)		52.60	50.90
DVI-I Dual Link(DID)		52.60	50.90

Dimensions are shown in millimeters

Contact Configuration

DVI-D Dual Link (DDD)	
	25 Contacts
DVI-I Dual Link (DID)	
	29 Contacts

DVI-D Single Link (DDS)	
	19 Contacts
DVI-I Single Link (DIS)	
	23 Contacts

* Design and specification are subject to change without notice.

Product Features

Receptacle

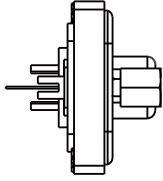

Backshell 8

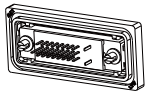

Straight (L)

Mating Style 7



Screw Thread (S)

Connector Body(Style) 3

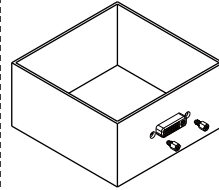

Front Fastened (P)

Overmolded with Cable

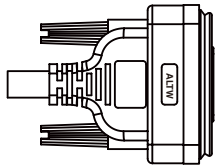

Backshell 8

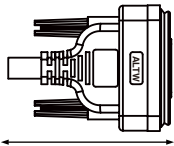

Straight
(L)

Mating Style 7



Screw Thread (S)

Connector Body(Style) 3

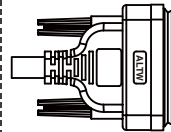

With Strain Relief (A)

Find Our Standard Products

↘ Receptacle and Mating Pair

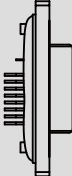
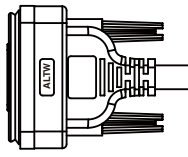
<ul style="list-style-type: none"> • Female Connector (Housing) • Female Contacts • Screw Thread 	Receptacle 	Overmolded with Cable 	Field Installable
	<small>** Choose UL20276 cable and select cable length from 1~5m</small>		
Code	Female Connector (F) Female Contacts (F)	Male Connector (M) Male Contacts (M)	Male Connector (M) Male Contacts (M)
DVI-D Single Link (DDS)	DDS-19PFFS-SL8001	DDS-19AMMM-SL7A**	-
DVI-D Dual Link (DDD)	DDD-25PFFS-SL8001	DDD-25AMMM-SL7A**	-
DVI-I Single Link (DIS)	DIS-23PFFS-SL8001	DIS-23AMMM-SL7A**	-
DVI-I Dual Link (DID)	DID-29PFFS-SL8001	DID-29AMMM-SL7A**	-

* For digital and analog, please choose DVI-I
 * For digital only, please choose DVI-D

RJ Connector



Range Overview

Receptacle and Mating Pair (Middle Size 13/16"-28UNS)

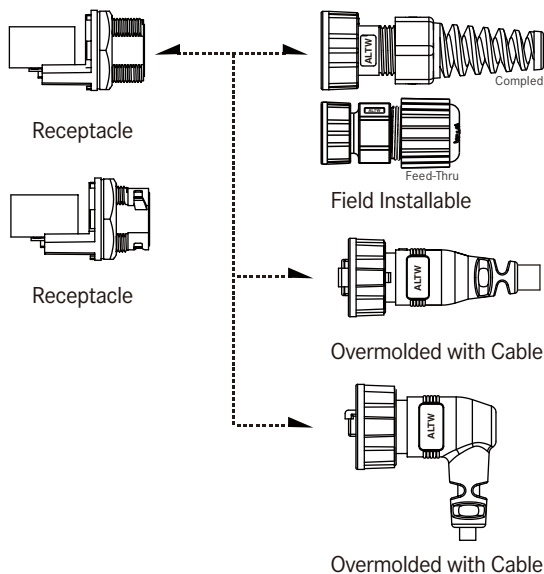

Receptacle and Mating Pair (Large Size 1"20-UNEF)

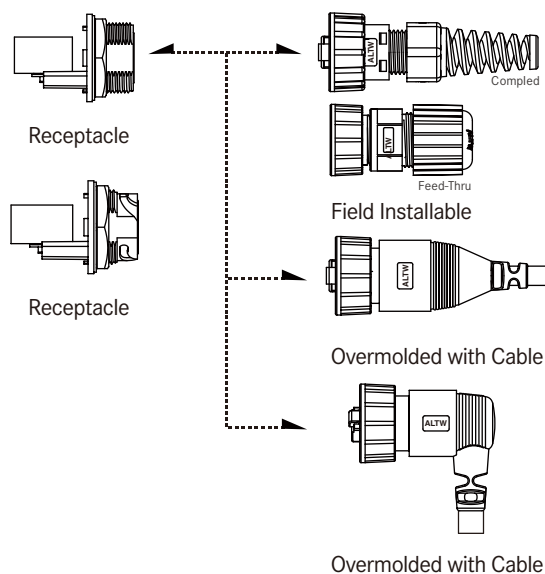

Receptacle and Mating Pair (ODVA)

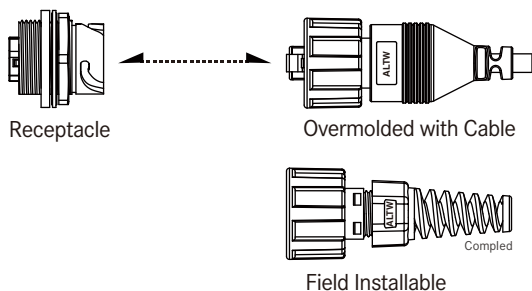

I Adaptor

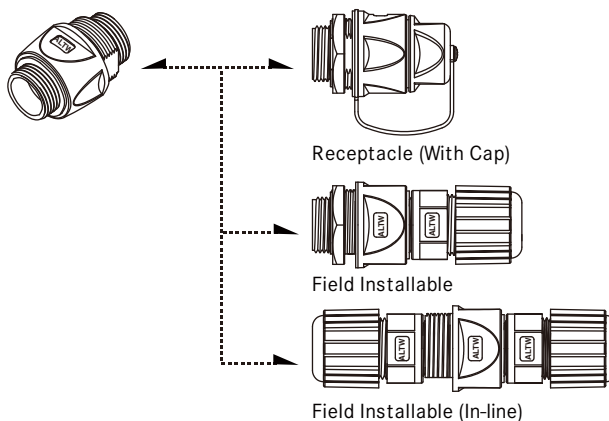

Accessories

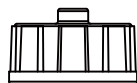

Waterproof Cap
See page 21-17

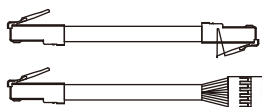

Patch Cable (Double-ended)
See page 21-24

* Design and specification are subject to change without notice.

Specification

Identifications	Middle Size: 13/16"-28 UNS (Cat. 5e) Large Size: 1"-20 UNS (Cat. 5e) ODVA (Cat. 5e)
Description	Receptacle Receptacle With Cable Overmolded with Cable Field Installable
Current Rating / Data	100 Base, 100 Base T and 1000 Base T Networks Cat 5E per TIA or EIA 568B Class D per ISO / IEC 11801
Material	Connector Body: -Housing: Polyester, UL94V-0, UV Resistant -Fastening Nut (Panel Side): Polyester UL94V-0,UV Resistant -Mating Lock Nut: Polyester , UL94V-0,UV Resistant RJ45 Jack and Plug Contacts: Phosphor Bronze, Gold Plated Cable Termination: Flame Protection per UL94V-0,UV Resistant
Waterproof Rating	IP67
Temperature Range	Receptacle: -40 °C~105 °C Overmolded with Cable: -20 °C~80 °C
Contact Resistance	≤ 20mΩ
Insulation Resistance	≥ 500mΩ at DC500V
Durability	750 cycles
Breakdown Voltage	≥ AC1000V / 1 minute
More to know	Thermal shock: -20°C~80°C 5cycls Salt Spray Corrosion: 48H POE: 60W /2A Standard Cable Length: 01-99M

Ordering Information

	1	2	3	4	5	6	7	8	9	10	
Specification											
(RCP) RJ45 C Size (Plastic)											
(RCM) RJ45 C Size (Metal)											
(RDP) RJ45 D Size (Plastic)											
(RDM) RJ45 D Size (Metal)											
(ROP) RJ45 ODVA (Plastic)											
Cat Type & Shielded											
(00) None										(5S) Cat.5e shielded	
(5U) Cat.5e Unshielded											
Connector Body (Style)											
> For Receptacle										> For Overmolded with Cable	
(P) Front Fastened										(A) With Strain Relief	
(R) Rear Fastened										(B) Without Strain Relief	
(D) Dual Fastened										> For Field Installable	
										(A) With Strain Relief	
										(B) Without Strain Relief	
Connector (Housing) Gender											
(MM) Plug										(FF) Jack	
Assemble Style											
> For Receptacle										> For Overmolded with Cable	
(H) Jack 180 (Horizontal)										(M) Overmolded with Cable	
(V) Jack 90 (Vertical)										> For Field Installable	
										(A) Field installable (Compled)	
										(S) Field installable (Feed-Thru)	
Mating Style											
(T) 3 Points Lock Bayonet										(S) Screw Thread	
Backshell											
> For Receptacle										> For Overmolded with Cable	> For Field Installable
(C) Circular										(L) Straight	(L) Straight
(S) Square										(R) Right Angle	
Waterproof Types											
(U) Unmated Waterproof										(M) Mated Waterproof	
Waterproof Rating											
(7) IP 67										*IP 68 upon request.	
More information											
> For Receptacle										> For Overmolded with Cable	
(001), (002).....										(□)+(■) : Cable Type + Cable Length	
										(□) : Cable Type	(■) : Cable Length
										(A) C5e UTP Solid Cable	From 1M to 99M
										(B) C5e FTP Solid Cable	EX. (01) = 1M

* Design and specification are subject to change without notice.

Ordering Information | Double-ended

ALTW waterproof connector to ALTW waterproof connector

ALTW waterproof connector to Standard RJ connector (None Waterproof)

f to Waterproof / Non-Waterproof

1 2 3 4 5 6 7 8 9

Specification (1st End)

(RCP) RJ45 C Size (Plastic)

(RCM) RJ45 C Size (Metal)

(RDP) RJ45 D Size (Plastic)

(RDM) RJ45 D Size (Metal)

(ROP) RJ45 ODVA (Plastic)

Cat Type & Shielded (1st End)

(5U) Cat.5e Unshielded

(5S) Cat.5e Shielded

Connector (Housing) Gender (1st End)

(M) Plug

(F) Jack

Specification (2nd End)

> For Waterproof Connectors

(RCP) RJ45 C Size (Plastic)

(RCM) RJ45 C Size (Metal)

(RDP) RJ45 D Size (Plastic)

(RDM) RJ45 D Size (Metal)

(ROP) RJ45 ODVA (Plastic)

> For Non-Waterproof Plug

(UPG) Unshielded Plug

(SPG) Shielded Plug

Cat Type & Shielded (2nd End)

> For Waterproof Connectors

(5U) Cat.5e Unshielded

(5S) Cat.5e Unshielded

> For Non-Waterproof Plug

(06) Gold Plating 6u"

Connector (Housing) Gender (2nd End)

(M) Plug

Mating Style

(T) 3 Points Lock Bayonet

(S) Screw Thread

Backshell

> For Overmolded with Cable

(L) Straight

(R) Right Angle

More information

> For Overmolded with Cable

(□)+(■) : Cable Type + Cable Length

(□) : Cable Type

(■) : Cable Length

(A) C5e UTP Solid Cable From 1M to 99M

(B) C5e FTP Solid Cable EX. (01) = 1M

Physical Dimension

Receptacle

Panel Cut-Out

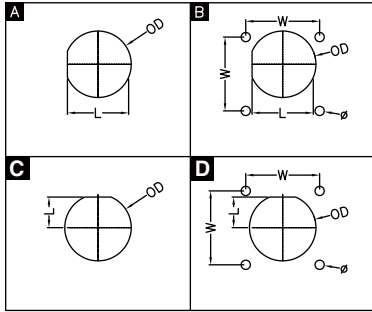

Type \ Dimension	Type	L / W	OD	∅
Connector Gender (Housing)	Female			
Middle Size (13/16"-28 UNS)	A	19.4	20.8	-
	B	19.4/24.4	20.8	3.1
Large Size (1"20 UNEF)	A	23.6	25.6	-
	B	23.6/24.4	25.6	3.1
ODVA	C	12.4	27.1	-
	D	12.4/25.9	27.1	M3.0*0.5

Dimensions are shown in millimeters

Connector Dimension

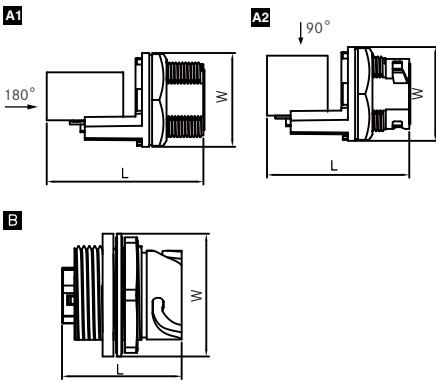

Type \ Dimension	Type	Shape	L	W
Connector Gender (Housing)	Female			
Middle Size (13/16"-28 UNS)	A1	Circle	44.0	26.0
		Square	44.0	32.0
	A2	Circle	39.9	26.0
		Square	39.9	32.0
Large Size (1"20 UNEF)	A1	Circle	44.0	32.0
		Square	44.0	
	A2	Circle	39.9	32.0
		Square	39.9	
ODVA	B	Circle	33.2	34.0
		Square	33.2	36.0

* Choose backshell: Circular (C) or Square Flange (S) | Dimensions are shown in millimeters

Overmolded with Cable

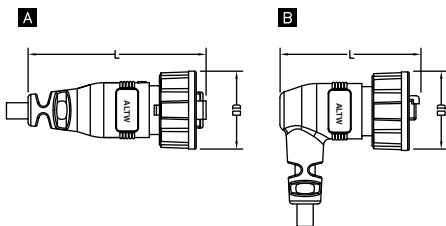

Type \ Dimension	Type	L		OD	
Connector Gender (Housing)		Female	Male	Female	Male
Middle Size (13/16"-28 UNS)	A	-	58.0	-	25.4
	B	-	45.0	-	25.4
Large Size (1"20 UNEF)	A	-	73.6	-	28.8
	B	-	53.4	-	28.8
ODVA	A	-	79.3	-	31.5

Dimensions are shown in millimeters

Field Installable

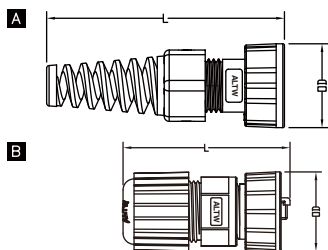

Type \ Dimension	Type	L		OD	
Connector Gender (Housing)		Female	Male	Female	Male
Middle Size (13/16"-28 UNS)	A	-	72.0	-	25.4
	B	-	40.7	-	25.4
Large Size (1"20 UNEF)	A	-	76.7	-	25.4
	B	-	59.7	-	32.0
ODVA	A	-	77.6	-	31.5

Dimensions are shown in millimeters

* Design and specification are subject to change without notice.

Product Features

Receptacle

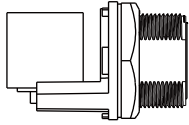

Backshell ⁷



Circular (C)

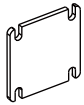

Square (S)

Assembly Style ⁵

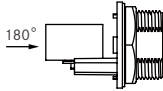

Jack 180
(Horizontal) (H)

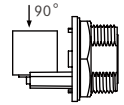

Jack 90 (Vertical) (V)

Mating Style ⁶



Screw Thread (S)



3 Points Lock (T)

Connector Body (Style) ³

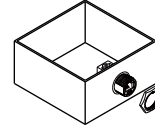

Front Fastened (P)

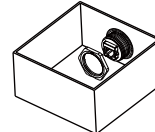

Rear Fastened (R)
(For ODVA only)

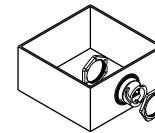

Double Fastened (D)
(For ODVA only)

Overmolded with Cable

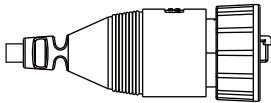

Backshell ⁷

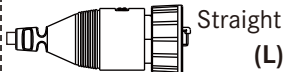

Straight
(L)



Right Angle
(R)

Mating Style ⁶



Screw Thread (S)



3 Points Lock (T)

Connector Body (Style) ³

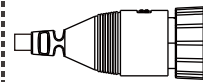

With Strain Relief (A)

Field Installable

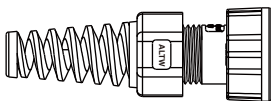

Backshell ⁷

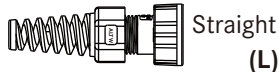

Straight
(L)

Mating Style ⁶



Screw Thread (S)



3 Points Lock (T)

Connector Body (Style) ³

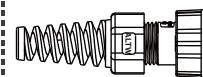

With Strain Relief (A)

* Refer to P8-4 for Ordering Information

Find Our Standard Products

▾ Middle Size 13/16"-28 UNS > Receptacle and Mating Pair

		Receptacle	Overmolded with Cable	Field Installable	
<ul style="list-style-type: none"> • Female Connector (Housing) • Female Contacts • Screw Thread 					
		<p>⑧ Choose unmated (U) or mated (M) waterproof</p>	<p>② Choose shielded (5S) or unshielded (5U) *** Choose the cable length:01-99m</p>	<p>*** Choose the cable length:01-99m</p>	
Cat. 5e		Female Connector (F) Female Contacts (F)	Male Connector (M) Male Contacts (M)	Male Connector (M) Male Contacts (M)	
Plastic	Jack 180	RCP-5SPFFH-SC ⑧ 7001 RCP-5SPFFH-SS ⑧ 7001	RCP-5 ② AMMM-SLM7*** RCP-5 ② AMMM-SRM7***	RCP5UM-RCP5UM-SL*** RCP5UM-RCP5UM-SR***	RCP-00AMMA-SLM7001 RCP-00BMMS-SLM7001
	Jack 90	RCP-5SPFFV-SC ⑧ 7001 RCP-5SPFFV-SS ⑧ 7001		RCP5UM-UPG06M-SL*** RCP5UM-UPG06M-SR***	
Metal	Jack 180	RCM-5SPFFH-SC ⑧ 7001 RCM-5SPFFH-SS ⑧ 7001	RCM-5 ② AMMM-SLM7*** RCM-5 ② AMMM-SRM7***	-	-
	Jack 90	RCM-5SPFFV-SC ⑧ 7001 RCM-5SPFFV-SS ⑧ 7001			

*Refer to P8-5 for ordering.

* Design and specification are subject to change without notice.

Middle Size 13-16"-28UNS

Receptacle and Mating Pair
3 Points Lock Bayonet

Receptacle | Unmated & Mated
Overmolded with Cable | Mated
Field Installable | Mated

▾ **Middle Size 13/16"-28 UNS > Receptacle and Mating Pair**

<ul style="list-style-type: none"> • Female Connector (Housing) • Female Contacts • 3 Points Lock Bayonet 		Receptacle →	Overmolded with Cable →		Field Installable
		8 Choose unmated (U) or mated (M) waterproof	2 Choose shielded (5S) or unshielded (5U) *** Choose the cable length: 01-99m	*** Choose the cable length: 01-99m	
Cat. 5e		Female Connector (F) Female Contacts (F)	Male Connector (M) Male Contacts (M)	Male Connector (M) Male Contacts (M)	Male Connector (M) Male Contacts (M)
Plastic	Jack 180	RCP-5SPFFH-TC 8 7001 RCP-5SPFFH-TS 8 7001	RCP-5 2 AMMM-TLM7*** RCP-5 2 AMMM-TRM7***	RCP5UM-RCP5UM-TL*** RCP5UM-RCP5UM-TR***	RCP-00AMMA-TLM7001 RCP-00BMMS-TLM7001
	Jack 90	RCP-5SPFFV-TC 8 7001 RCP-5SPFFV-TS 8 7001		RCP5UM-UPG06M-TL*** RCP5UM-UPG06M-TR***	

*Refer to P8-5 for ordering information.

Large Size 1"-20 UNEF > Receptacle and Mating Pair

<ul style="list-style-type: none"> Female Connector (Housing) Female Contacts Screw Thread 		<p>Receptacle</p>	<p>Overmolded with Cable</p>	<p>Field Installable</p>	
<p>8 Choose unmated (U) or mated (M) waterproof</p>		<p>2 Choose shielded (5S) or unshielded (5U) *** Choose the cable length:01-99m</p>	<p>*** Choose the cable length:01-99m</p>		
Cat. 5e		Female Connector (F) Female Contacts (F)	Male Connector (M) Male Contacts (M)	Male Connector (M) Male Contacts (M)	Male Connector (M) Male Contacts (M)
Plastic	Jack 180	RDP-5SPFFH-SC 8 7001 RDP-5SPFFH-SS 8 7001	RDP-5 2 AMMM-SLM7*** RDP-5 2 AMMM-SRM7***	RDP5UM-RDP5UM-SL*** RDP5UM-RDP5UM-SR***	RDP-00AMMA-SLM7001 RDP-00BMMS-SLM7001
	Jack 90	RDP-5SPFFV-SC 8 7001 RDP-5SPFFV-SS 8 7001		RDP5UM-UPG06M-SL*** RDP5UM-UPG06M-SR***	
Metal	Jack 180	RDM-5SPFFH-SC 8 7001 RDM-5SPFFH-SS 8 7001	RDM-5 2 AMMM-SLM7*** RDM-5 2 AMMM-SRM7***	-	-
	Jack 90	RDM-5SPFFV-SC 8 7001 RDM-5SPFFV-SS 8 7001			

*Refer to P8-5 for ordering information.

* Design and specification are subject to change without notice.

Large Size 1"-20 UNEF

Receptacle and Mating Pair
3 Points Lock Bayonet

IP 67 9

Receptacle | Unmated & Mated
Overmolded with Cable | Mated
Field Installable | Mated

↘ **Large Size 1"-20 UNEF > Receptacle and Mating Pair**



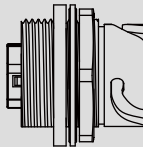
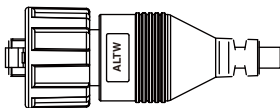
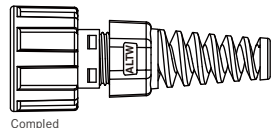

<ul style="list-style-type: none"> • Female Connector (Housing) • Female Contacts • 3 Points Lock Bayonet 		Receptacle	Overmolded with Cable		Field Installable
		<p>8 Choose unmated (U) or mated (M) waterproof</p>	<p>2 Choose shielded (5S) or unshielded (5U) *** Choose the cable length:01-99m</p>	<p>*** Choose the cable length:01-99m</p>	<p>5 Choose Completed (A) or Feed-Thru (S)</p>
Cat. 5e		Female Connector (F) Female Contacts (F)	Male Connector (M) Male Contacts (M)	Male Connector (M) Male Contacts (M)	Male Connector (M) Male Contacts (M)
Plastic	Jack 180	RDP-5SPFFH-TC 8 7001 RDP-5SPFFH-TS 8 7001	RDP-5 2 AMMM-TLM7*** RDP-5 2 AMMM-TRM7***	RDP5UM-RDP5UM-TL*** RDP5UM-RDP5UM-TR***	RDP-00AMM 5 -TLM7001 RDP-00BMMS-TLM7001
	Jack 90	RDP-5SPFFV-TC 8 7001 RDP-5SPFFV-TS 8 7001		RDP5UM-UPG06M-TL*** RDP5UM-UPG06M-TR***	

*Refer to P8-5 for ordering information.

ODVA > Receptacle and Mating Pair

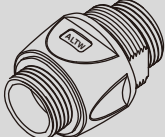
<ul style="list-style-type: none"> • Female Connector • Female Contacts • 3 Points Lock Bayonet • ODVA 	<p>Receptacle</p> 	<p>Overmolded with Cable</p> 	<p>Field Installable</p>  <p>Completed</p>
	<p>3 Choose the Back shell position: Front (P) or Rear (R) or Double (D) Mounting</p> <p>8 Choose unmated (U) or mated (M) waterproof</p>	<p>*** Choose the cable length:01-99m</p>	
ODVA (ROP)	Female Connector (F) Female Contacts (F)	Male Connector (M) Male Contacts (M)	Male Connector (M) Male Contacts (M)
Jack 180°	ROP-5S 3 FFH-TC 8 7001 ROP-5S 3 FFH-TS 8 7001	ROP-5SAMMM-TLM7***	ROP-00AMMA-TLM7001

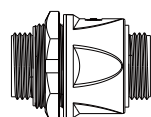
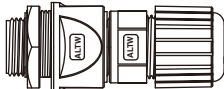
I Adaptor

<ul style="list-style-type: none"> • Shielded RJ45 • Front Fastened • Screw Thread • Backshell: Circular • Panel Thickness Max: 3.5mm • IP 67   <p>Upon request</p>		 <p>* Field Installable with cap available (Upon Request)</p>	
	Type 1 Receptacle	Type 2 Field Installable	Type 3 Field Installable (In-line)
	RDP-00PFFH-SCU7001	RDP-00PFFA-SLM7001	RDP-00BFFA-SLM7001

* Design and specification are subject to change without notice.

SSL Connector

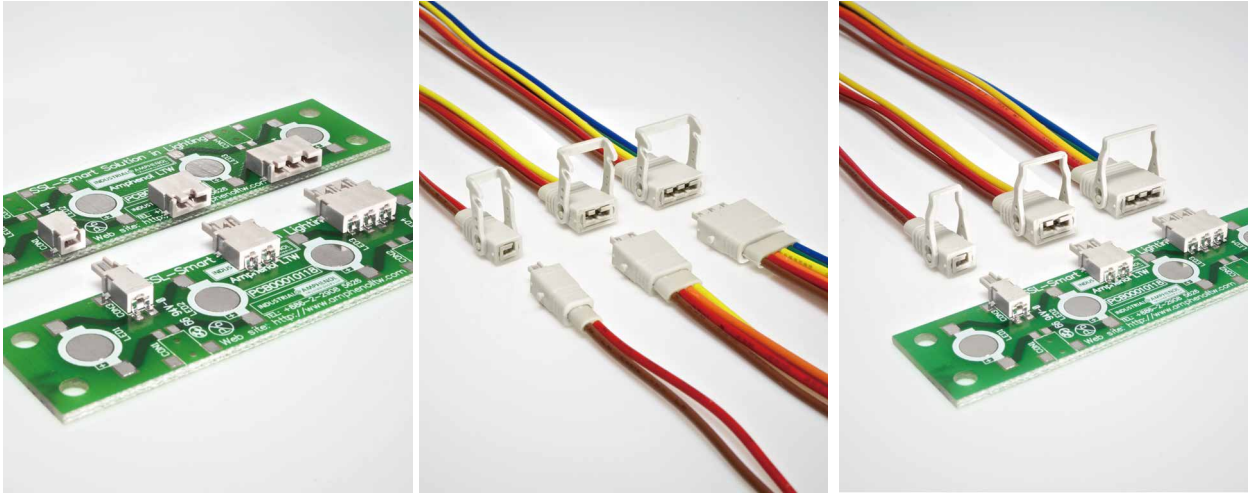

Range Overview

▾ PCB Mount to PCB Mount

Right Angle

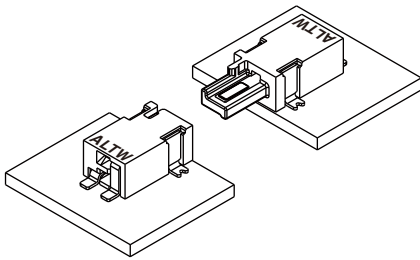

Straight

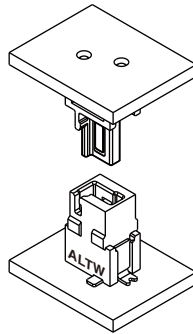

Right Angle & Straight

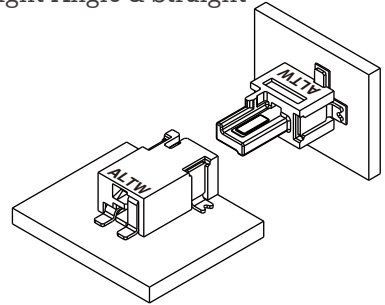

▾ PCB Mount to Wire

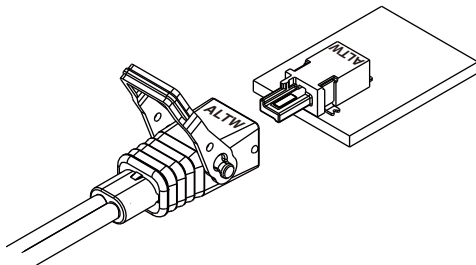

▾ Wire to Wire

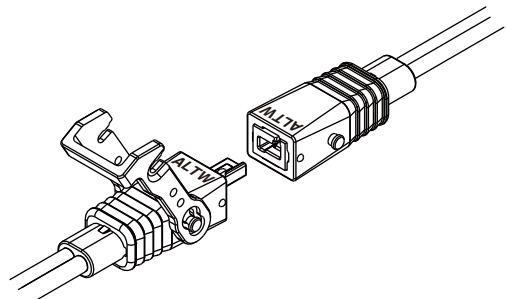

Specification

Identifications	SSL 1.1 DC Connector (PCB Connector & Cable)
Description	PCB to PCB PCB to Wire Wire to Wire
Current Rating / Data	3A per Pin 2, 4 & 6P
Voltage Rating	Max100 VAC / VDC
Material	Contact: Copper Alloy, Tin over Nickel Housing: LCP, UL 94V-0 Rated Hood: Nylon (PA66), UL 94V-0 Rated Lock: Nylon (PA66), UL 94V-0 Rated SR: PP, UL 94V-0 Rated. UL recognized wire & flat cable available
Temperature Range	-40°C ~ +100°C
Contact Resistance	≤ 20mΩ
Insulation Resistance	≥ 1000mΩ at 250VDC
Durability	100 cycles
Breakdown Voltage	1200 V AC
More to know	Standard cable length: every 10cm

Ordering Information

- 1
- 2
- 3
- 4
- 5
- 6
- 7
- 8

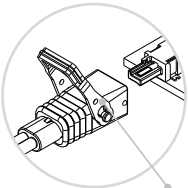
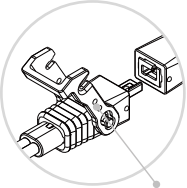
Connector Series (11) SSL 1.1 None Waterproof Series	
Connector (Housing) Gender (J) Jack	(P) Plug
Number of Contacts 2,4, 6 contacts EX. (2) = 2 Contacts	
Connector Type	
> For PCB Mount Type	> For Wire Assembly
(A) SMT Board Straight with Post	(L) Wire Assembly, Straight, With SR
(C) SMT Board Right Angle with Post	
(D) SMT Board Right Angle without Post	
Wires Assembly Options	
> For PCB Mount Type	> For Wire Assembly
(00) For PCB Mount Type	(2J) 2-End Jack Connector
	(2P) 2-End Plug Connector
	(JP) End 1: Jack, End 2: Plug,
	(JO) End 1: Jack, End 2: Open
	(PO) End 1: Plug, End 2: Open
Lock Option	
(0) None (Without Lock)	(T) With Two W2W Lock
(B) W2B Lock in End 1	(S) W2B Lock in End 1, W2W Lock in End 2
(W) W2W Lock in End 1	
(D) With Two W2B Lock	
	
Wire to Board Lock (W2B Lock)	Wire to Wire Lock (W2W Lock)
Wire Size	
> For PCB Mount Type	> For Wire Assembly
(00) Not Applicable for SMT Board	(22) 22 AWG

Wire Assembly / Wires Type

<p>> For PCB Mount Type (001), (002)..... Without Wire : Different Versions</p>	<p>> For Wire Assembly (□)+(■) : Wire Type + Length EX. (A01) = Wire + 10cm (□) : Wire Type (A) UL recognized wire (D) UL recognized flat cable (■) : Length From 10cm~990cm EX.(01) = 10cm</p>
--	--

Physical Dimension

▮ PCB Mount to PCB Mount > Right Angle

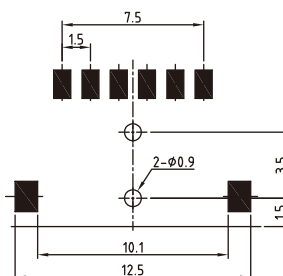
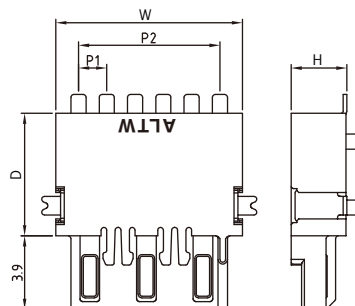
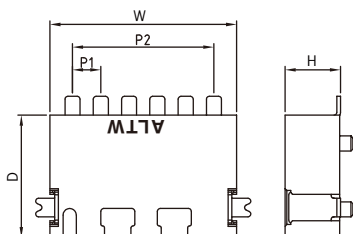
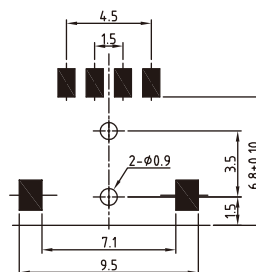
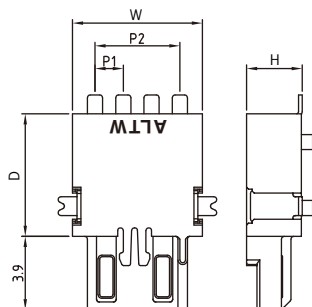
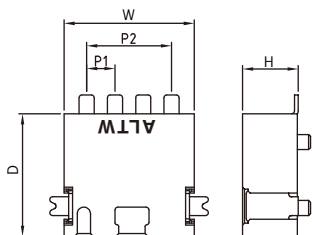
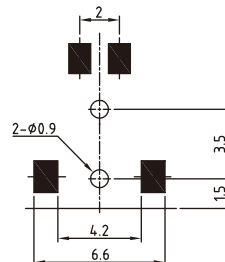
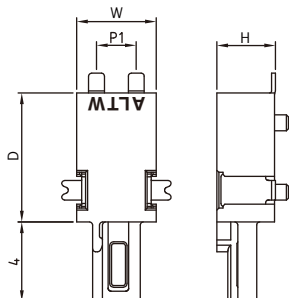
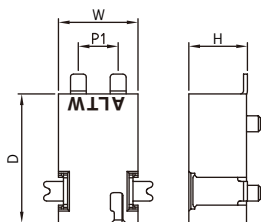

	P1 Pitch	P2 TTL Pitch	D Depth	W Width	H Height
2P	2.0	-	6.5	4.0	3.0
4P	1.5	4.5	6.5	6.9	3.0
6P	1.5	7.5	6.5	9.9	3.0

Dimensions are shown in millimeters

* Design and specification are subject to change without notice.

▾ PCB Mount to PCB Mount > Straight

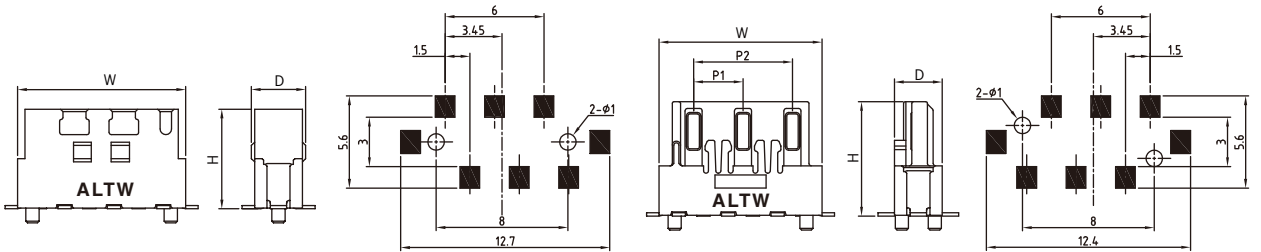
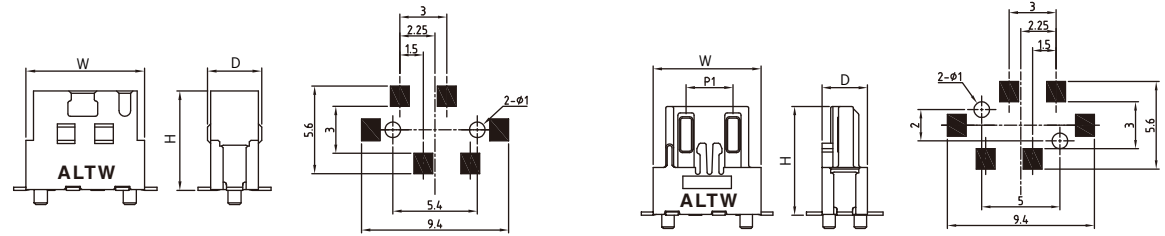
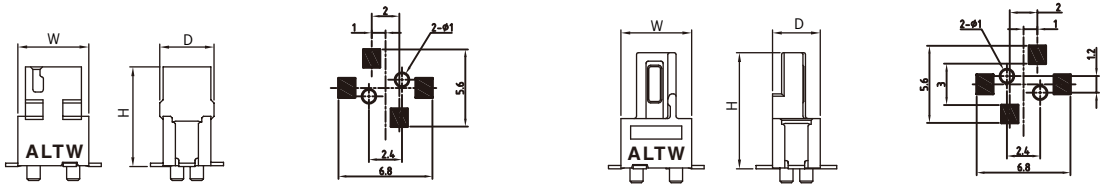

	P1 Pitch	P2 TTL Pitch	D Depth	W Width	H Height
2P	-	-	Jack: 3.3 Plug: 2.9	Jack: 4.3 Plug: 4.3	Jack: 6.0 Plug: 7.0
4P	3.0	-	Jack: 3.3 Plug: 2.9	Jack: 7.2 Plug: 6.9	Jack: 6.0 Plug: 7.0
6P	3.0	6.0	Jack: 3.3 Plug: 2.9	Jack: 10.2 Plug: 9.9	Jack: 6.0 Plug: 7.0

Dimensions are shown in millimeters

Wire Assembly

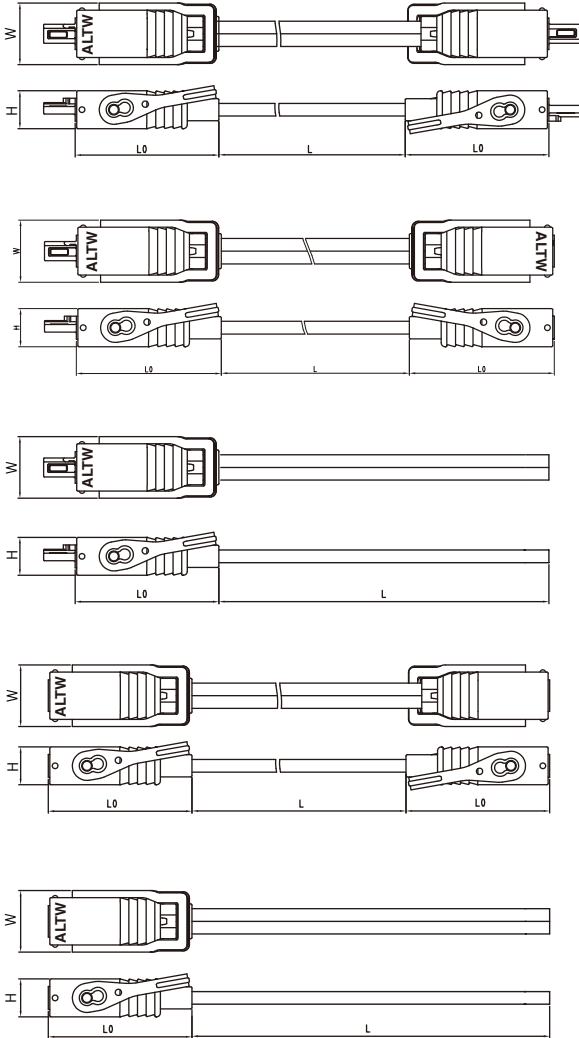

	L0	H	W	Cable Length (L)
2P	16.2	4.8	7.8	**Wire & flat cable length available from 10cm to 990cm in multiples of 10cm.
4P	16.2	4.8	11.2	
6P	16.2	4.8	14.2	

* Design and specification are subject to change without notice.

Find Our Standard Products

▾ PCB Mount to PCB Mount > Right Angle

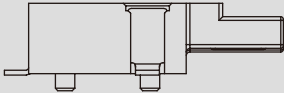
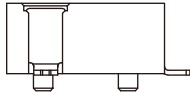
		
	④ PCB Mount (Right Angle) ; With post (C) or without post (D)	④ PCB Mount (Right Angle) ; With post (C) or without post (D)
	Plug	Jack
2P	SSL11-P 2 ④ 00-000001	SSL11-J 2 ④ 00-000001
4P	SSL11-P 4 ④ 00-000001	SSL11-J 4 ④ 00-000001
6P	SSL11-P 6 ④ 00-000001	SSL11-J 6 ④ 00-000001

▾ PCB Mount to PCB Mount > Straight

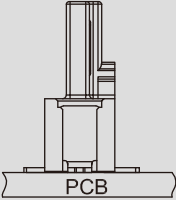
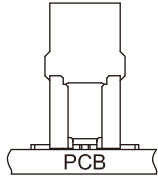
		
	④ PCB Mount (Straight) ; With post (A) or without post (B)	④ PCB Mount (Straight) ; With post (A) or without post (B)
	Plug	Jack
2P	SSL11-P2 ④ 00-000001	SSL11-J 2 ④ 00-000001
4P	SSL11-P4 ④ 00-000001	SSL11-J 4 ④ 00-000001
6P	SSL11-P6 ④ 00-000001	SSL11-J 6 ④ 00-000001

PCB Mount to PCB Mount > Right Angle & Straight

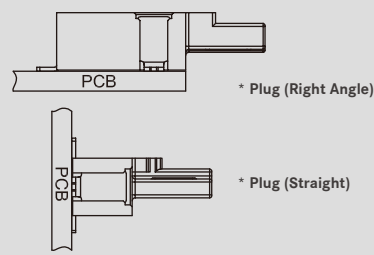
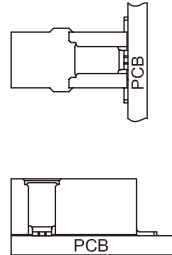
 <p>* Plug (Right Angle) * Plug (Straight)</p> <p>4 PCB Mount (Right Angle) ; With post (C) or without post (D) PCB Mount (Straight) ; With post (A) or without post (B)</p>		 <p>* Jack (Straight) * Plug (Right Angle)</p>
	Plug	Jack
2P	SSL11-P 2 4 00-000001	SSL11-J 2 4 00-000001
4P	SSL11-P 4 4 00-000001	SSL11-J 4 4 00-000001
6P	SSL11-P 6 4 00-000001	SSL11-J 6 4 00-000001

PCB Mount (Plug) to Wire

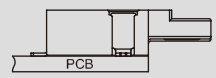
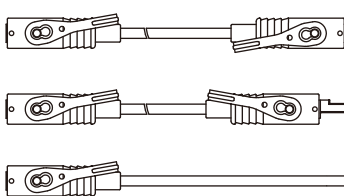
 <p>4 PCB Mount (Right Angle) ; With post (C) or without post (D)</p>		 <p>**Wire & flat cable length available from 10cm to 990cm in multiples of 10cm. EX. (01) = 10cm</p>			
	Mount Type		End 1 + End 2	Cable Type	Part Number
2P	Right Angle Plug	SSL11-P2 4 00-000001	Jack + Jack	Flat Cable	SSL11-J2L2J-D22D**
			Jack + Plug	Flat Cable	SSL11-P2LJP-D22D**
			Jack + Open End	Wire	SSL11-J2LJ0-B22A**
				Flat Cable	SSL11-J2LJ0-B22D**
4P	Right Angle Plug	SSL11-P4 4 00-000001	Jack + Jack	Flat Cable	SSL11-J4L2J-D22D**
			Jack + Plug	Flat Cable	SSL11-P4LJP-D22D**
			Jack + Open End	Wire	SSL11-J4LJ0-B22A**
				Flat Cable	SSL11-J4LJ0-B22D**
6P	Right Angle Plug	SSL11-P6 4 00-000001	Jack + Jack	Flat Cable	SSL11-J6L2J-D22D**
			Jack + Plug	Flat Cable	SSL11-P6LJP-D22D**
			Jack + Open End	Wire	SSL11-J6LJ0-B22A**
				Flat Cable	SSL11-J6LJ0-B22D**

* Design and specification are subject to change without notice.

↳ PCB Mount (Jack) to Wire

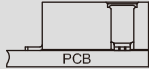
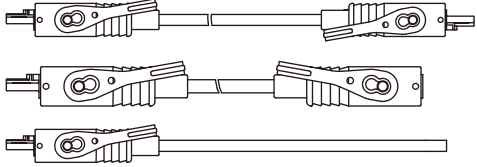
		 <p>4 PCB Mount (Right Angle) ; With post (C) or without post (D)</p>			
				<p>**Wire & flat cable length available from 10cm to 990cm in multiples of 10cm. EX. (01) = 10cm</p>	
Mount Type	Jack	End 1 + End 2	Cable Type	Part Number	
2P	SSL11-J2 4 00-000001	Plug + Plug	Flat Cable	SSL11-P2L2P-D22D**	
		Plug + Jack	Flat Cable	SSL11-P2LJP-D22D**	
		Plug + Open End	Wire	SSL11-P2LP0-B22A**	
Flat Cable	SSL11-P2LP0-B22D**				
4P	SSL11-J4 4 00-000001	Plug + Plug	Flat Cable	SSL11-P4L2P-D22D**	
		Plug + Jack	Flat Cable	SSL11-P4LJP-D22D**	
		Plug + Open End	Wire	SSL11-P4LP0-B22A**	
Flat Cable	SSL11-P4LP0-B22D**				
6P	SSL11-J6 4 00-000001	Plug + Plug	Flat Cable	SSL11-P6L2P-D22D**	
		Plug + Jack	Flat Cable	SSL11-P6LJP-D22D**	
		Plug + Open End	Wire	SSL11-P6LP0-B22A**	
Flat Cable	SSL11-P6LP0-B22D**				

↳ Wire to Wire

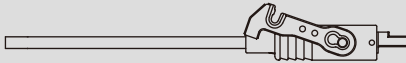
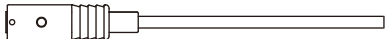
					
		<p>**Wire & flat cable length available from 10cm to 990cm in multiples of 10cm. EX. (01) = 10cm</p>		<p>**Wire & flat cable length available from 10cm to 990cm in multiples of 10cm. EX. (01) = 10cm</p>	
Cable Type	Plug	Jack			
2P	Wire	SSL11-P2LP0-W22A**	SSL11-J2LJ0-022A**		
	Flat Cable	SSL11-P2LP0-W22D**	SSL11-J2LJ0-022D**		
4P	Wire	SSL11-P4LP0-W22A**	SSL11-J4LJ0-022A**		
	Flat Cable	SSL11-P4LP0-W22D**	SSL11-J4LJ0-022D**		
6P	Wire	SSL11-P6LP0-W22A**	SSL11-J6LJ0-022A**		
	Flat Cable	SSL11-P6LP0-W22D**	SSL11-J6LJ0-022D**		

LED Indicator



Range Overview

▾ Receptacle

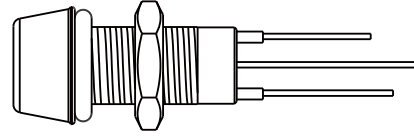

Specification

Identifications	M8 LED (Plastic or Metal)
Description	Receptacle with LED light
LED Size	Metal LED: $\phi 3\text{mm}$, $\phi 5\text{mm}$ Plastic LED: $\phi 3\text{mm}$
Material	Connector Body: Metal: Copper Alloy, Nickel Plated Plastic: PC+ABS
Waterproof Rating	IP67
Temperature Range	Metal: $-20^{\circ}\text{C} \sim +105^{\circ}\text{C}$ Plastic: $-20^{\circ}\text{C} \sim +85^{\circ}\text{C}$
Operating Voltage	4V
Light Color	Red, Blue, Green, White, Yellow, Red / Green
More to know	Absolute Maximum Ratings at $T_a=25^{\circ}\text{C}$ - Power Dissipation: 80~120mW Max - Peak Forward Current: 100mA Max - Continuous Forward Current: 20~35mA Max - Lead Soldering Temperature: 260°C for 5 Seconds

Ordering Information

	1	2	3	4	5	6	7	8	9	10
Specification (L08) M8										
Number of LED (01) 1 LED										
Light Color Style (R) Red (B) Blue (G) Green										
			(W) White (A) Red/Green (Y) Yellow							
LED Size (A) \varnothing 3mm										
			(B) \varnothing 5mm							
Electrical Type (A) DC 4V										
Assemble Style > For Receptacle (S) Solder Type (P) 180° PCB Type										
Housing Material (M) Metal										
			(P) Plastic							
Backshell > For Receptacle (R) Circular / Rear Fastened										
Waterproof Rating (7) IP 67										
More Information > For Receptacle (001) Without Cable										

* Design and specification are subject to change without notice.

Physical Dimension

Receptacle

Panel Cut-Out

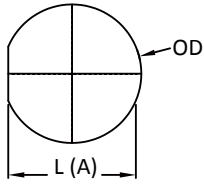

Size \ Dimension	L (A)	OD	L (B)	W
L08 - ϕ 3.0 (Plastic)	7.1	8.2	21.0	10.5
L08 - ϕ 3.0 (Metal)	7.1	8.2	20.0	10.5
L08 - ϕ 5.0 (Metal)	7.1	8.2	20.0	10.5

* Maximum Panel Thickness: 6.5mm

Dimensions are shown in millimeters

Connector Dimension

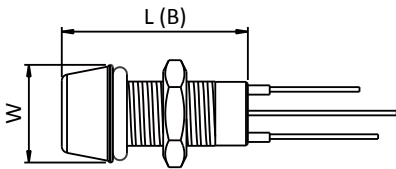

Find Our Standard Products

Receptacle

• Plastic connectors	<p>Receptacle</p> <p>3 Choose the color of LED: - Mono-color: Red (R) / Blue (B) / Green (G) / White (W) / Yellow (Y) The size of plastic LED: ϕ3mm</p>
	<p>LED M8 Plastic</p> <p>L08-01 3 AAS-PR700 1</p>

Receptacle

• Metal connectors	<p>Receptacle</p> <p>3 Choose the color of LED: - Mono-color: Red (R) / Blue (B) / Green (G) / White (W) / Yellow (Y) - Multi-color: Red & Green (A) 4 Choose the size of LED (ϕ3mm (A) or ϕ5mm (B))</p>
	<p>LED M8 Metal</p> <p>L08-01 3 4 AS-MR700 1</p>

HDMI Connector



Range Overview

Receptacle to Overmolded with Cable

Rectangle Type

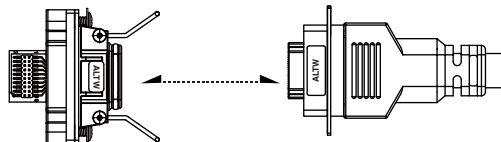

Receptacle

Overmolded with Cable

Circular Type

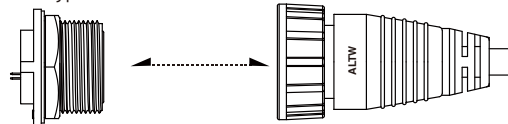

Receptacle

Overmolded with Cable

Accessories



Waterproof Cap
See page 21-17

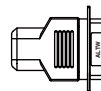

Waterproof Cap
See page 21-17

Specification

Identifications	HDMI connector
Description	Receptacle Overmolded with Cable
Current Rating / Data	0.5A
Material	Contacts: Phospor Bronze Connector Body (Housing): PBT Shell: Brass
Waterproof Rating	IP67 (Mated Waterproof)
Temperature Range	Receptacle: -20°C~80°C Overmolded with Cable: -20°C~80°C
Contact Resistance	≤ 20mΩ
Insulation Resistance	≥ 100mΩ at DC500V
More to know	Standard Cable Length: 01~05 M

Ordering Information

	1	2	3	4	5	6	7	8	9	10
Specification										
(HJ) HDMI Jack										
(HP) HDMI Plug										
Number of Contacts										
(19) 19 Contacts										
Connector Body (Style)										
> For Receptacle										
(P) Front Fastened										
> For Overmolded with Cable										
(A) With Strain Relief										
Connector (Housing) Gender										
(M) Male (Plug)										
(F) Female (Jack)										
Contact Gender										
(M) Male (Stamp)										
(F) Female (Stamp)										
Assemble Style										
> For Receptacle										
(R) 90° PCB Type										
> For Overmolded with Cable										
(M) Overmolded with Cable										
(P) 180° PCB Type										
Mating Style										
(Q) Latch										
(S) Screw Thread										
Backshell										
> For Receptacle										
(S) Rectangle										
> For Overmolded with Cable										
(L) Straight										
(C) Circular										
Waterproof Rating										
(7) IP 67										
More information										
> For Receptacle										
(001), (002).....										
Without Cable : Different										
Versions										
> For Overmolded with Cable										
(□)+(■) : Cable Type + Cable Length										
EX. (A01) = UL20276 Cable + 1M										
(□) : Cable Type										
(■) : Cable Length										
(A) UL20276 Cable From 1M to 5M										
EX. (01) = 1M										

* Design and specification are subject to change without notice.

Physical Dimension

Receptacle

Panel Cut-Out

Rectangle Type

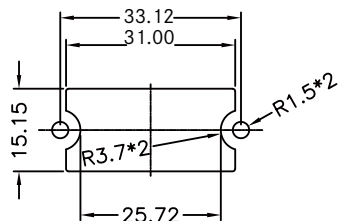

Circular Type

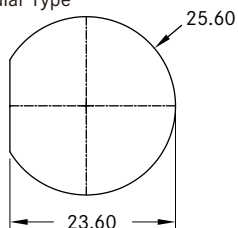

Connector Dimension

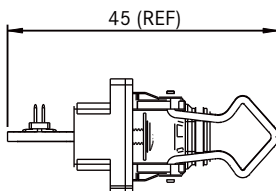

Connector Dimension

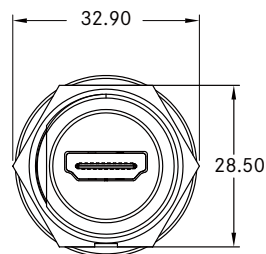
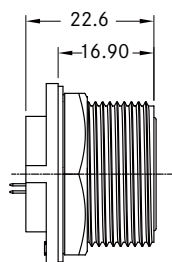
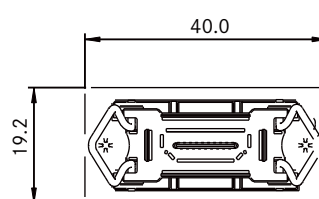

Overmolded with Cable

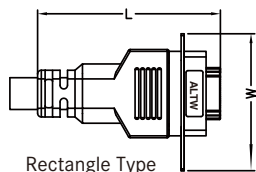

Rectangle Type

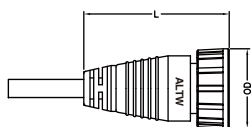

Circular Type

Dimension	L	W / OD
Current Rating		
Connector Gender	Male	
Rectangle Type	48.1	32.0
Circular Type	58.7	32.0

Dimensions are shown in millimeters

Contact Configuration

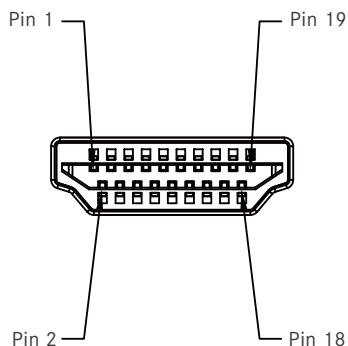

PCB Layoyt

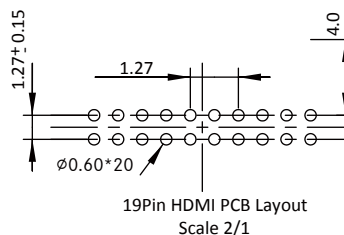

* This only show contact configuration of Jack as your reference.

Product Features

Receptacle

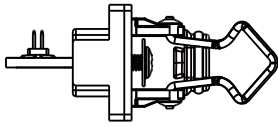

Rectangle Type

Mating Style 7

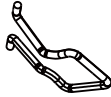

Latch (Q)

Connector Body(Style) 3

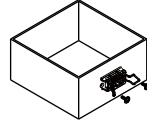

Front Fastened (P)

Backshell 8



Rectangle (S)

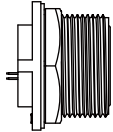

Circular Type

Mating Style 7



Screw Thread (S)

Connector Body(Style) 3

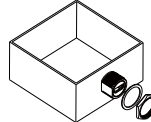

Front Fastened (P)

Backshell 8



Circular (C)

Overmolded with Cable

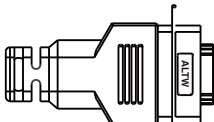

Rectangle Type

Mating Style 7

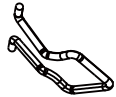

Latch (Q)

Connector Body(Style) 3

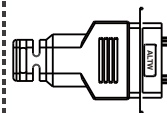

With Strain Relief (A)

Backshell 8

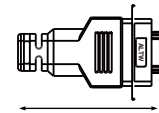

Straight (L)

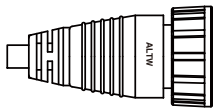

Circular Type

Mating Style 7



Screw Thread (S)

Connector Body(Style) 3

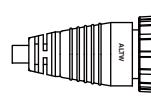

With Strain Relief (A)

Backshell 8

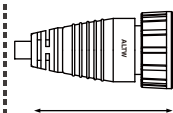

Straight (L)

Find Our Standard Products

Receptacle and Mating Pair

	Receptacle	Overmolded with Cable	Field Installable
<ul style="list-style-type: none"> Female Connector (Housing) Female Contacts Latch Screw Thread 	Rectangle Type Circular Type	Rectangle Type Circular Type ** Choose UL20276 cable and select cable length from 01~05m	
Connector Style	Female Connector (F) Female Contacts (F)	Male Connector (M) Male Contacts (M)	Male Connector (M) Male Contacts (M)
Rectangle Type	HJ-19PFFR-QS7001	HP-19AMMM-QL7A**	-
Circular Type	HJ-19PMFP-SC7001	HP-19AFMM-SL7A**	-

* Design and specification are subject to change without notice.

Sata Connector



Range Overview

∟ Receptacle to Overmolded with Cable

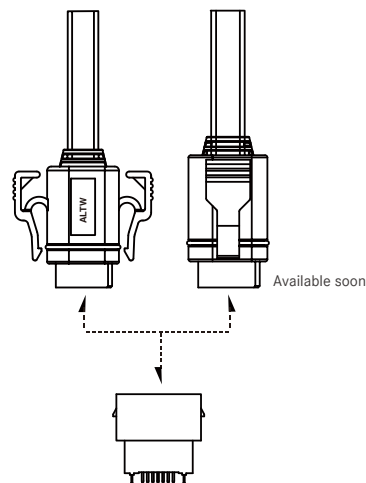

Specification

Identifications	SATA II connector
Description	PCB to Wire
Current Rating	1.5 A
Material	Contacts: Copper Alloy, Gold Plated Connector Body (Housing): LCP / PBT
Waterproof Rating	IP67
Temperature Range	Receptacle: -20°C~80°C Overmolded with Cable: -20°C~80°C
Contact Resistance	≤ 30mΩ
Insulation Resistance	≥ 1000mΩ at DC500V
Durability	500 cycles
More to know	SATA III (upon request)

Ordering Information

	1	2	3	4	5	6	7
Specification							
(SA7) SATA 7 Pin Type							
Type							
(2) SATA II							
							* SATA III upon request
Connector (Housing) Gender							
> For Receptacle / PCB							> For Overmolded with Cable
(P) Female (Socket)							(A) Male (Plug)
Connector Body							
> For Receptacle / PCB							> For Overmolded with Cable
(S) SMD							(L) Cable Latch (Double)
(D) DIP							(P) Cable Latch (Single)
Board Lock / Cable Type							
> For Receptacle / PCB							> For Overmolded with Cable
(TA) Flat Board Lock 2.6mm							(DU) 2 End Cable Type
(TB) Flat Board Lock 1.6mm							(SN) 1 End Cable Type
(FA) Harpoon Board Lock 2.6mm							
(FB) Harpoon Board Lock 3.2mm							
Waterproof Rating							
(7) IP 67							
More Information							
> For Receptacle							> For Overmolded with Cable
(001) Without Cable							(A01) 100MM
							(A05) 500MM

* Design and specification are subject to change without notice.

Physical Dimension

Receptacle

DIP Layout

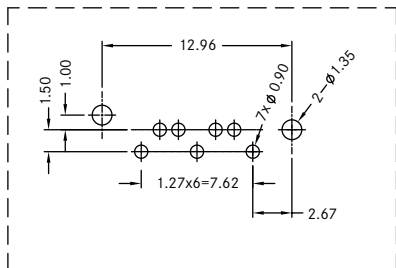

Board Lock Type

Harpoon

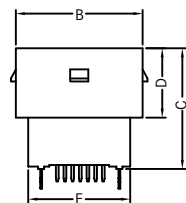
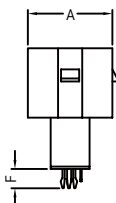

Flate

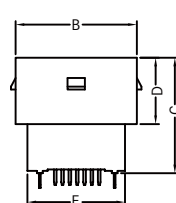
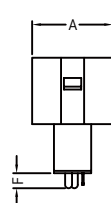

A	B	C	D	E	F
14.0	21.0	20.0	11.5	16.9	2.6
					3.2
14.0	21.0	20.0	11.5	16.9	2.6
					1.6

Receptacle

SMT Layout

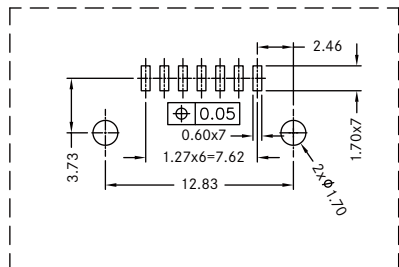

Board Lock Type

Harpoon

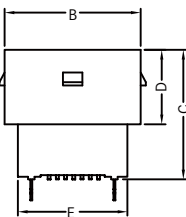
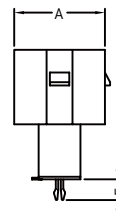

Flate

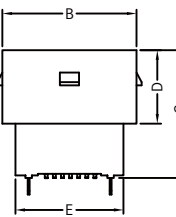
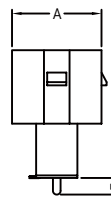

A	B	C	D	E	F
14.0	21.0	20.0	11.5	16.9	2.6
					3.2
14.0	21.0	20.0	11.5	16.9	2.6
					1.6

Overmolded with Cable

Cable Latch (Double)

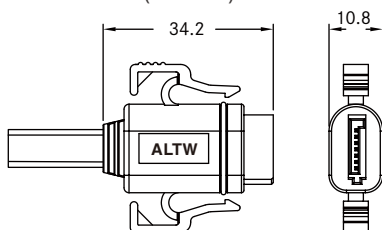

Cable Latch (Single)

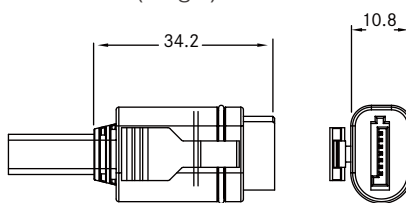

Contact Configuration

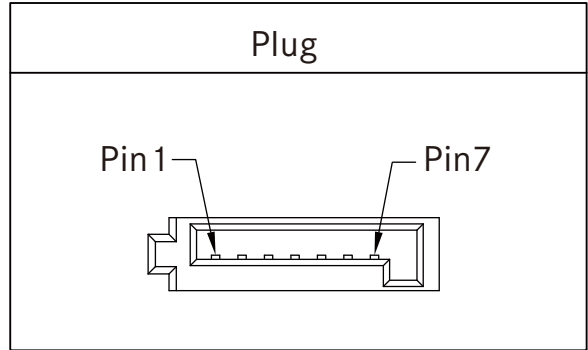
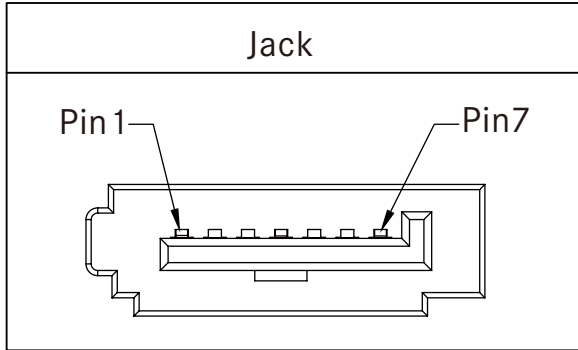

Find Our Standard Products

▾ Receptacle and Mating Pair

	Receptacle> 	Overmolded with Cable
	Jack	Plug
SATA II	SA7-2PDFA-7001 SA7-2PDFB-7001 SA7-2PDTA-7001 SA7-2PDTB-7001 SA7-2PSFA-7001 SA7-2PSFB-7001 SA7-2PSTA-7001 SA7-2PSTB-7001	SA7-2ALDU-7AXX SA7-2APDU-7AXX *Upon request

* Design and specification are subject to change without notice.

Fiber Optic Connector



Range Overview

∟ Receptacle to Field Installable

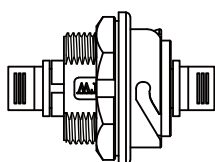

Receptacle

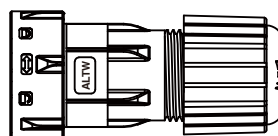

Field Installable

∟ Accessories

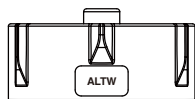

Waterproof Cap
See page 21-18

Specification

Identifications	LC Type SC Type
Description	Receptacle Field Installable
Material	Receptacle: Mousing: PPO Screw Nut: Nylon Field Installable: Clamp Ring: PPO Lock Nut: PPO Sealing Nut: Nylon
Waterproof Rating	IP67
Temperature Range	Receptacle: -40 °C ~ 105 °C Field Installable: -40 °C ~ 105 °C

* Design and specification are subject to change without notice.

Physical Dimension

Receptacle

Panel Cut-Out

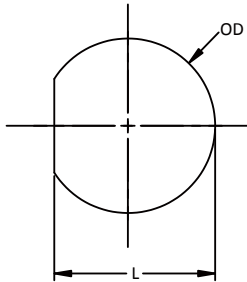

Type \ Dimension	L	OD
LC Type	23.60	25.60
SC Type	23.60	25.60

* Maximum Panel Thickness: 4mm

Dimensions are shown in millimeters

Connector Dimension

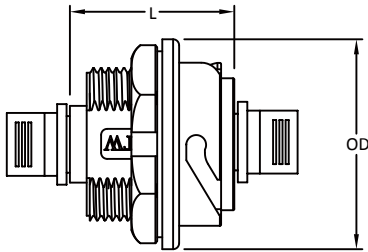

Field Installable

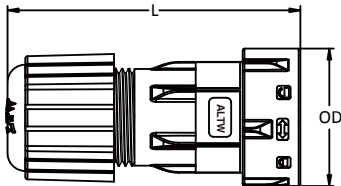

Type \ Dimension	L	W
LC Type	66.0	32.6
SC Type	66.0	32.6

Dimensions are shown in millimeters

* Design and specification are subject to change without notice.

Product Features

Receptacle

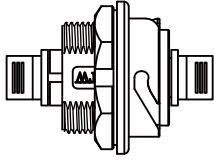

Backshell 7



Circle (C)

Mating Style 6



3 Points Lock Bayonet (T)

Connector Body(Style) 3

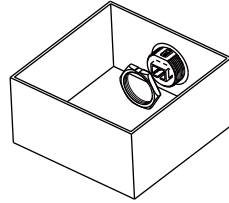

Rear Fastened (R)

Field Installable

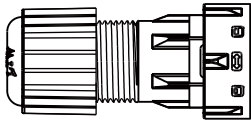

Backshell 7

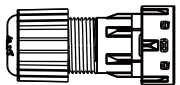

Straight (L)

Mating Style 6



3 Points Lock Bayonet (T)

Connector Body(Style) 3

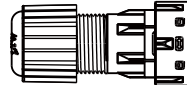

Without Strain Relief (B)

Find Our Standard Products

Receptacle and Mating Pair

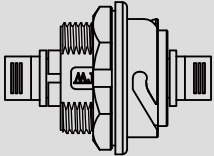
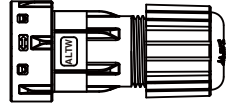
<ul style="list-style-type: none"> • Female Connector (Housing) • 3 Point Lock Bayonet 	<p>Receptacle </p> 	<p>Field Installable</p> 
Type	Female Connector (F)	Male Connector (M)
LC Type (L)	FB-00RLFJ-TC7001	FB-00BLMA-TL7001 FB-00BLMA-TL7002
SC Type (S)	FB-SMRSFJ-TC7001	FB-00BSMA-TL7001

FB-00BLMA-TL7001 (Cable OD: 2.5~2.8)
 FB-00BLMA-TL7002 (Cable OD: 4.5~6.8)
 FB-00BSMA-TL7001 (Cable OD: 2.4 max)

* Design and specification are subject to change without notice.

NMEA 2000 Connector

Range Overview

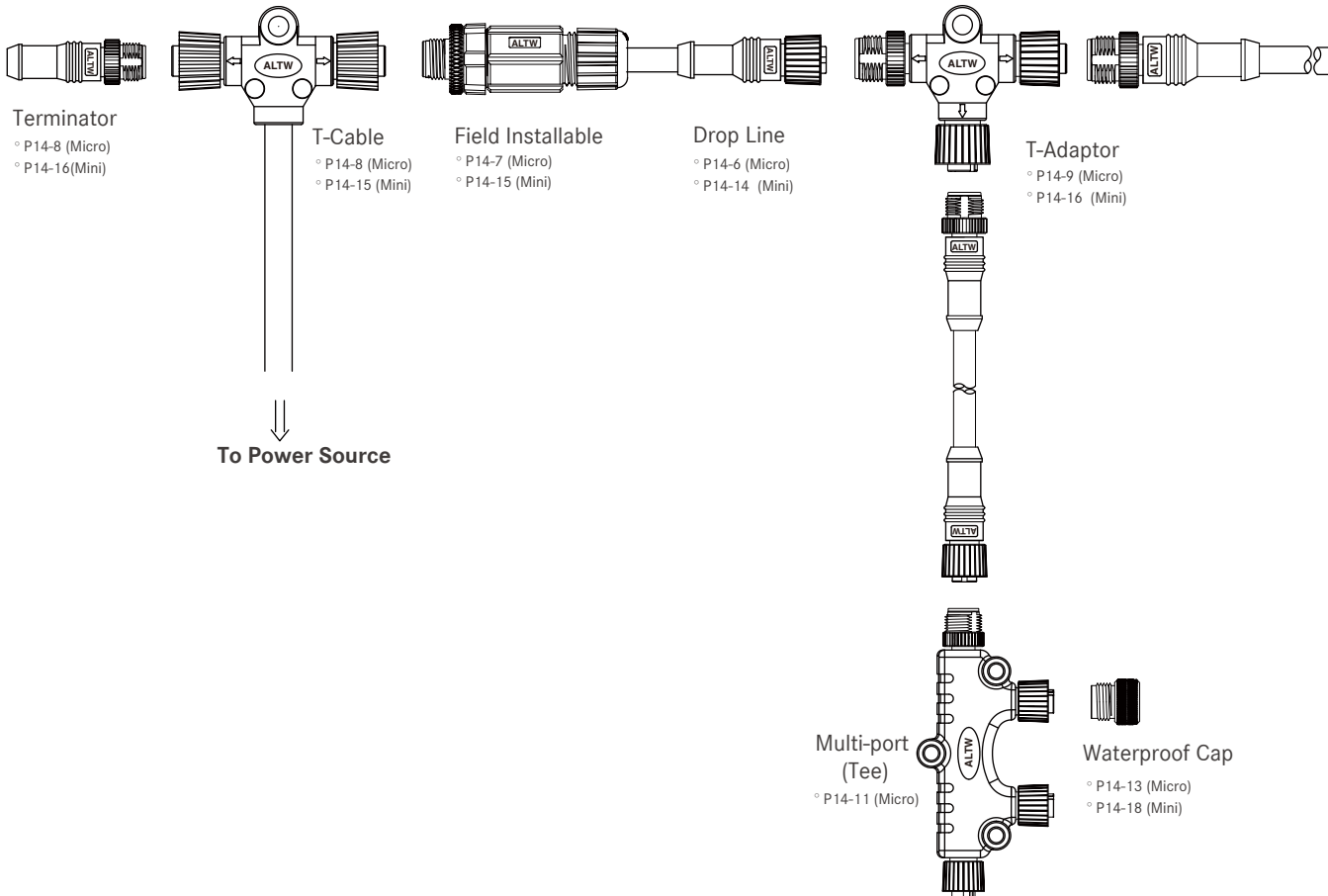

About NMEA 2000

Amphenol LTW Technology expands its coverage targeting the marine industry that features the NMEA 2000 standard.

The NMEA 2000 standard contains the requirements of a serial data communications network to inter-connect marine electronic equipment on

vessels. It is multi-master and self-configuring, and there is no central network controller. Equipment designed to this standard will have the ability to

share data, including commands and status with other compatible equipment over a status with other compatible equipment over a single channel.

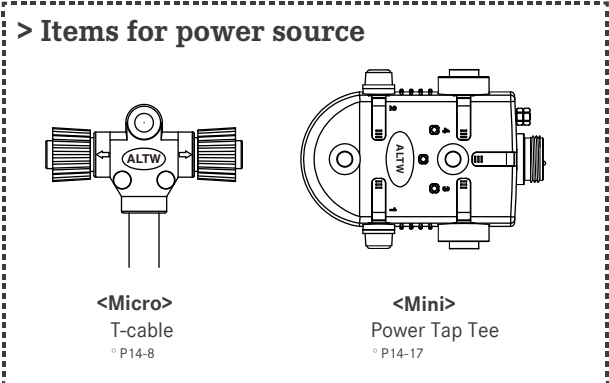
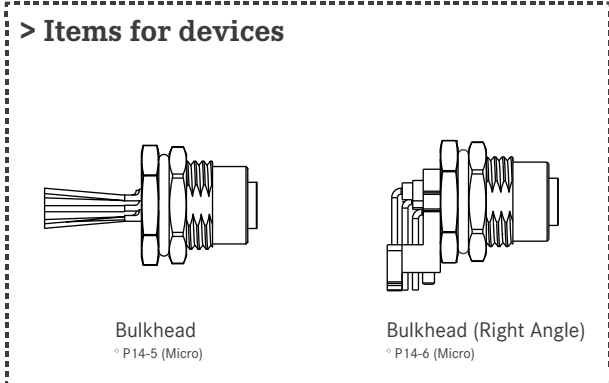
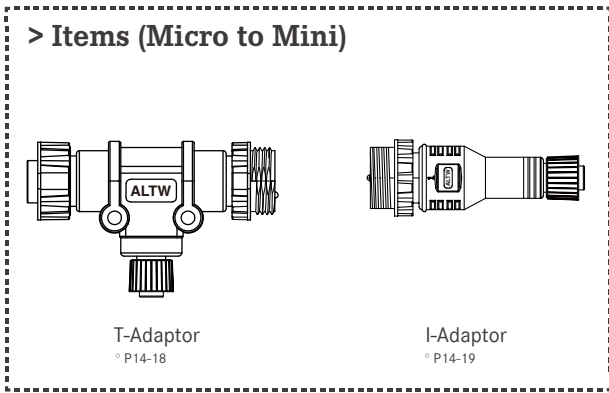
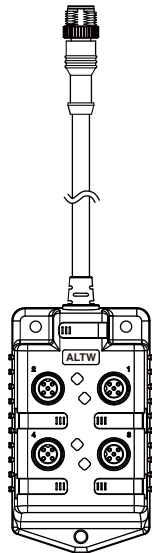
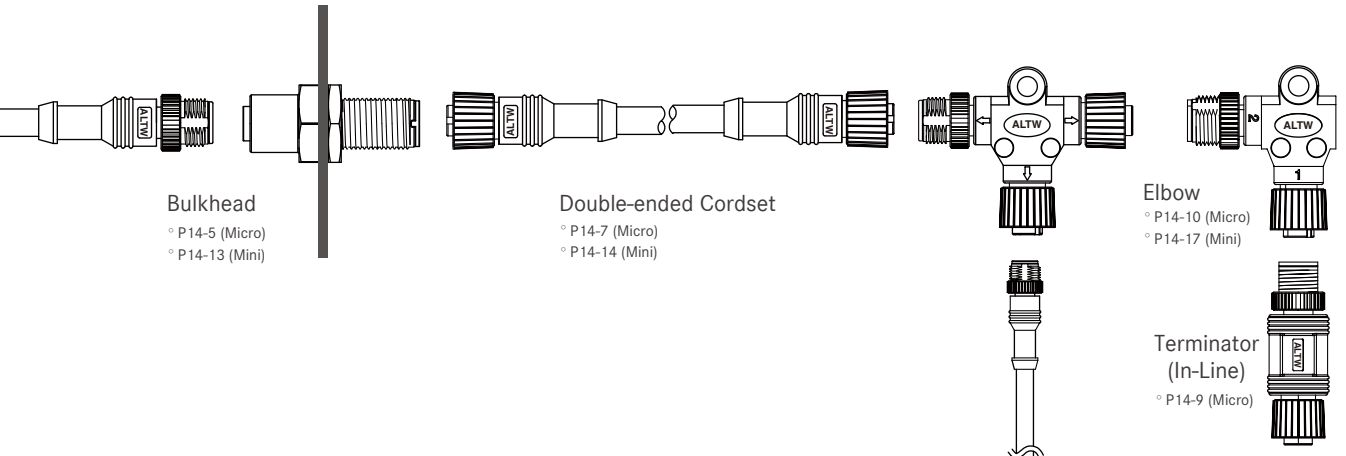

* Design and specification are subject to change without notice.

Specification

Identifications	Micro(AWG: 22 AWG, 24 AWG) Mini(AWG: 18 AWG, 15 AWG)
Description	<p>Micro: Bulkhead (With Wire / Double-ended / Right Angle) Cable (Drop Line / Double-ended Cordset / Field Installable / T-Cable) Network Terminator (Single-ended / In-line) Adaptor (T-Adaptor / Elbow) Multi-port Waterproof Cap</p> <p>Mini: Bulkhead (Double-ended) Cable (Drop Line / Double-ended Cordset / Field Installable / T-Cable) Network Terminator (Single-ended) Adaptor (T-Adaptor / Elbow) Power Tap Tee Waterproof Cap</p> <p>Mini to Micro: Adaptor (T-Adaptor / I-Adaptor)</p>
Current Rating / Data	4A, 8A
Material	Contacts: Copper Alloy, Gold Plated Contacts Holder: PA
Waterproof Rating	IP67~68
Temperature Range	Receptacle: -40°C~85°C Overmolded with Cable: -20°C~80°C Field Installable: Nylon+GF: -40°C~105°C PU: -20°C~85°C * Higer working temperature upon request.

Contact Configuration

	Micro-C	Mini-C
	4A	8A
	FF or MM	FF or MM
4Pin		
5Pin		

△ 4A
○ 8A

Number of Contacts:
Ex.2 contacts (02)

Connector (Housing) Gender:
Male(M) or Female(F)

Contact Gender:
Male(M) or Female(F)

More to Choose:

- Solder (S)
- Solder Cup



- Screw In (B)



Cabling Information

Micro

NMEA Approved

(A): (24#* 1P+AL) + (22#* 1P+AL) + Drain + Mylar + Braid

Conforming

(A): (24#* 1P+AL) + (22#* 1P+AL) + Drain + AL + Braid

(B): (22#* 1P+AL) + (18#* 1P+AL) + Drain + AL + Braid

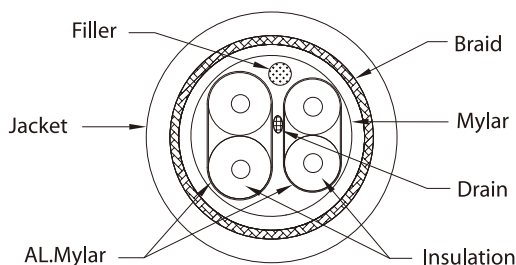

Mini

NMEA Approved

(C): (18#* 1P+AL) + (15#* 1P+AL) + Drain + Braid

Conforming

(C): (18#* 1P+AL) + (16#* 1P+AL) + Drain + AL+Braid

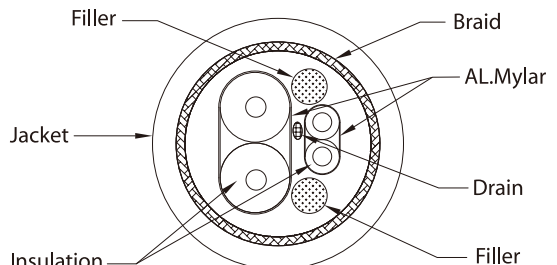

* Design and specification are subject to change without notice.

Find Our Standard Products

Micro > Bulkhead (Double-ended)

<ul style="list-style-type: none"> • 5 Contacts • Screw Thread • Unmated IP68 	<p>18 (Hexagon) For Panel thickness Max 8.5mm</p>	
Type	Connector	Connector 1 (Female Connector / Female Contacts)
	Connector	Connector 2 (Male Connector / Male Contacts)
None- Certified NMEA 2000 (4A, 60V)	MC-000505-0FM-BS001	
Certified NMEA 2000 (4A, 60V)	UMC-000505-0FM-BS001	

Micro > Bulkhead

<ul style="list-style-type: none"> • 5 Contacts • Screw Thread • For device side • Unmated IP68 	<p>* Front Fastened Male: 25.9 Female: 22.9 Male: 20.5 Female: 20.0 18 (Hexagon) OD: 15.4 13.6</p> <p>* Rear Fastened Male: 24.5 Female: 28.0 Male: 22.0 Female: 22.6 18 (Hexagon) OD: 15.4 13.6</p>		
Type	Connector	Connector (Male Connector / Male Contacts)	Connector (Female Connector / Female Contacts)
	None- Certified NMEA 2000 (4A, 60V)	MC-05PMMS-SF8001 MC-05PMMS-SH8001	MC-05PFFS-SF8001 MC-05PFFS-SH8001

Micro > Bulkhead (Right Angle)

<ul style="list-style-type: none"> • 5 Contacts • Screw Thread • For device side • Unmated IP68 / Mated IP67 	<p>* IP 68 (Unmated)</p>		<p>* IP 67 (Mated)</p>	
	<p>Connector Type</p>	<p>Connector (Male Connector / Male Contacts)</p>	<p>Connector (Female Connector / Female Contacts)</p>	<p>Connector (Male Connector / Male Contacts)</p>
<p>None- Certified NMEA 2000 (4A, 60V)</p>	<p>12-05PMMR-SF7001 12-05PMMR-SF8001</p>	<p>12-05PFFR-SF7001 12-05PFFR-SF8001</p>	<p>12-05PMMR-SF7001 12-05PMMR-SF8001</p>	<p>12-05PFFR-SF7001 12-05PFFR-SF8001</p>
<p>None- Certified NMEA 2000 (Plastic / 4A, 60V)</p>	<p>12P-05PMMR-SF8001</p>	<p>12P-05PFFR-SF8001</p>	<p>12P-05PMMR-SF8001</p>	<p>12P-05PFFR-SF8001</p>

Micro > Cable > Drop Line

<ul style="list-style-type: none"> • 5 Contacts • Screw Thread • For power tap connection • Mated IP68 				<p>10 Cabling Information NMEA Approved (A): (24#*1P+AL) + (22#*1P+AL) + Drain + Mylar + Braid Conforming (A): (24#*1P+AL) + (22#*1P+AL) + Drain + AL + Braid (B): (22#*1P+AL) + (18#*1P+AL) + Drain + AL + Braid **Available in 1, 2, 5, 10 M.</p>
	<p>Connector Type</p>	<p>Connector (Male Connector / Male Contacts)</p>	<p>Connector (Female Connector / Female Contacts)</p>	<p>Connector (Male Connector / Male Contacts)</p>
<p>None- Certified NMEA 2000 (4A, 60V)</p>	<p>MC-05BMMM-SL8 10 **</p>	<p>MC-05BFFM-SL8 10 **</p>	<p>MC-05BMMM-SL8 10 **</p>	<p>MC-05BFFM-SL8 10 **</p>
<p>None- Certified NMEA 2000 (Plastic / 4A, 60V)</p>	<p>MCP-05BMMM-SL8 10 **</p>	<p>MCP-05BFFM-SL8 10 **</p>	<p>MCP-05BMMM-SL8 10 **</p>	<p>MCP-05BFFM-SL8 10 **</p>
<p>Certified NMEA 2000 (4A, 60V)</p>	<p>UMC-05BMMM-SL8 10 **</p>	<p>-</p>	<p>UMC-05BMMM-SL8 10 **</p>	<p>-</p>

* Design and specification are subject to change without notice.

Micro > Cable > Double-ended Cordset

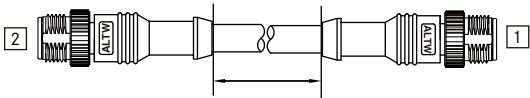
<ul style="list-style-type: none"> • 5 Contacts • Screw Thread • Mated IP68 	 <p>*Available in 1, 2, 5, 10 M</p>			
	*Cable 22+24+B PVC			
Type	Connector	Connector 1 (Male Connector Male Contacts)	Connector 1 (Female Connector Female Contacts)	Connector 1 (Male Connector Male Contacts)
		Connector 2 (Male Connector Male Contacts)	Connector 2 (Female Connector Female Contacts)	Connector 2 (Female Connector Female Contacts)
	None- Certified NMEA 2000 (4A, 60V)	MC-000505-0MM-CS*	MC-000505-0FF-CS*	MC-000505-0MF-CS*
	None- Certified NMEA 2000 (Plastic / (4A, 60V)	PC-000505-0MM-CS*	PC-000505-0FF-CS*	PC-000505-0MF-CS*
	Certified NMEA 2000 (4A, 60V)	-	-	UMC-000505-0MF-CSA*

Micro > Cable > Field Installable

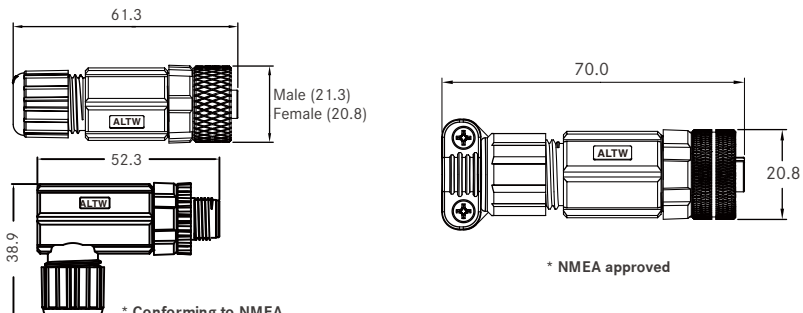
<ul style="list-style-type: none"> • 5 Contacts • Screw Thread • Screw-in Contacts • Mated IP68 	 <p>* Conforming to NMEA</p> <p>* NMEA approved</p>		
	Connector	Connector (Male Connector / Male Contacts)	Connector (Female Connector / Female Contacts)
Type			
	None- Certified NMEA 2000 (4A, 60V)	12-05BMMB-SL7001 12-05BMMB-SR7001 (Ø4.5 ~Ø6.0mm; 18AWG Max.)	12-05BFFB-SL7001 12-05BFFB-SR7001 (Ø4.5 ~Ø6.0mm; 18AWG Max.)
	None- Certified NMEA 2000 (Plastic / 4A, 60V)	12P-05BMMB-SL7001 12P-05BMMB-SR7001 (Ø4.5 ~Ø6.0mm; 18AWG Max.)	12P-05BFFB-SL7001 12P-05BFFB-SR7001 (Ø4.5 ~Ø6.0mm; 18AWG Max.)
	Certified NMEA 2000 (4A, 60V)	UMC-05BMMB-SL7001 (Ø4.5 ~Ø7.5mm; 18AWG Max.)	UMC-05BFFB-SL7001 (Ø4.5 ~Ø7.5mm; 18AWG Max.)

Micro > Cable > T-Cable

<ul style="list-style-type: none"> • 5 Contacts • Screw Thread • For Power Tap Connection • Mated IP68 				
	<p>*Cable 22+18+B PVC *Available in 1, 2, 5, 10 M.</p>			
Type	Connector	Connector 1 (Male Connector Male Contacts)	Connector 1 (Female Connector Female Contacts)	Connector 1 (Female Connector Female Contacts)
	Connector	Connector 2 (Male Connector Male Contacts)	Connector 2 (Female Connector Female Contacts)	Connector 2 (Male Connector Male Contacts)
None- Certified NMEA 2000 (4A, 60V)		MC-050500-MM0-TSB*	MC-050500-FF0-TSB*	MC-050500-FM0-TSB*
None- Certified NMEA 2000 (Plastic) (4A, 60V)		PC-050500-MM0-TSB*	PC-050500-FF0-TSB*	PC-050500-FM0-TSB*
Certified NMEA 2000 (4A, 60V)		-	-	UMC-050500-FM0-TSA*

Micro > Network terminator > Terminator

<ul style="list-style-type: none"> • 5 Contacts • Screw Thread • With 120Ω Resistor • Mated IP68 			
	<p>*Design and specification are subject to change without notice.</p>		
Type	Connector	Connector (Male Connector / Male Contacts)	Connector (Female Connector / Female Contacts)
	Connector	MC-05BMMT-SL8001	MC-05BFFT-SL8001
None- Certified NMEA 2000 (4A, 60V)		MCP-05BMMT-SL8001	MCP-05BFFT-SL8001
None- Certified NMEA 2000 (Plastic / 4A, 60V)		UMC-05BMMT-SL8001	UMC-05BFFT-SL8001
Certified NMEA 2000 (4A, 60V)			

* Design and specification are subject to change without notice.

Micro > Network Terminator > Terminator (In-Line)

<ul style="list-style-type: none"> • 5 Contacts • Screw Thread • With 120Ω Resistor • Mated IP68 		
Type	Connector 1 (Male Connector / Male Contacts)	Connector 1 (Female Connector / Female Contacts)
	Connector 2 (Female Connector / Female Contacts)	Connector 2 (Female Connector / Female Contacts)
None- Certified NMEA 2000 (4A, 60V)	MC-000505-0MF-IS001	* Please contact our sales team for more information

Micro > Adaptor > T-Adaptor

<ul style="list-style-type: none"> • 5 Contacts • Screw Thread • Mated IP68 		
Type	Connector 1 (Female Connector / Female Contacts)	
	Connector 2 (Male Connector / Male Contacts)	
	Connector 3 (Female Connector / Female Contacts)	
None- Certified NMEA 2000 (4A, 60V)	UMC-050505-FMF-TS001	

Micro > Adaptor > Elbow

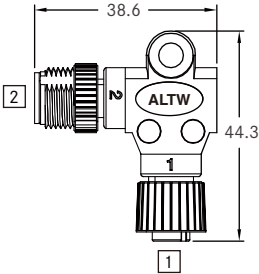
<ul style="list-style-type: none"> • 5 Contacts • Screw Thread • Mated IP68 	
<p>Type</p>	<p>Connector 1 (Female Connector / Female Contacts)</p>
<p>Connector</p>	<p>Connector 2 (Male Connector / Male Contacts)</p>
<p>None- Certified NMEA 2000 (4A, 60V)</p>	<p>MC-000505-0FM-ES001</p>

* Design and specification are subject to change without notice.

Micro > Adaptor > T-Adaptor

- 5 Contacts
- Screw Thread
- Mated IP68

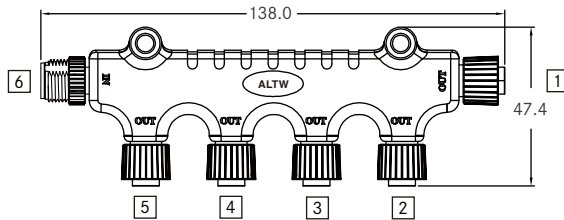

Type Connector	Connector 1 (Female Connector / Female Contacts)	Connector 1 (Female Connector / Female Contacts)
	Connector 2 (Female Connector / Female Contacts)	Connector 2 (Female Connector / Female Contacts)
	Connector 3 (Female Connector / Female Contacts)	Connector 3 (Female Connector / Female Contacts)
	Connector 4 (Male Connector / Male Contacts)	Connector 4 (Female Connector / Female Contacts)
	-	Connector 5 (Female Connector / Female Contacts)
	-	Connector 6 (Male Connector / Male Contacts)
None- Certified NMEA 2000 (4A, 60V)	S-555500-FFFM00-S001	S-555555-FFFFFM-S001
Certified NMEA 2000 (4A, 60V)	E-555500-FFFM00-S001	E-555555-FFFFFM-S001

Micro > Multi-port > Box

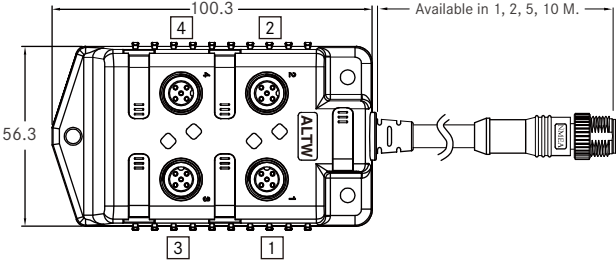
<ul style="list-style-type: none"> • 5 Contacts • Screw Thread • Mated IP68 	 <p>* Cable 22+18+B PVC ** Cable 22+24+B PVC</p>								
<p>Type</p>	<table border="1"> <tr> <td data-bbox="386 652 614 740">Connector</td> <td data-bbox="614 652 1328 740">Connector 1 (Female Connector / Female Contacts)</td> </tr> <tr> <td data-bbox="386 740 614 829">Connector</td> <td data-bbox="614 740 1328 829">Connector 2 (Female Connector / Female Contacts)</td> </tr> <tr> <td data-bbox="386 829 614 917">Connector</td> <td data-bbox="614 829 1328 917">Connector 3 (Female Connector / Female Contacts)</td> </tr> <tr> <td data-bbox="386 917 614 1001">Connector</td> <td data-bbox="614 917 1328 1001">Connector 4 (Female Connector / Female Contacts)</td> </tr> </table>	Connector	Connector 1 (Female Connector / Female Contacts)	Connector	Connector 2 (Female Connector / Female Contacts)	Connector	Connector 3 (Female Connector / Female Contacts)	Connector	Connector 4 (Female Connector / Female Contacts)
Connector	Connector 1 (Female Connector / Female Contacts)								
Connector	Connector 2 (Female Connector / Female Contacts)								
Connector	Connector 3 (Female Connector / Female Contacts)								
Connector	Connector 4 (Female Connector / Female Contacts)								
<p>None- Certified NMEA 2000 (4A, 30V)</p>	<p>S-555500-FFFF00-SB*</p>								
<p>Certified NMEA 2000 (4A, 30V)</p>	<p>E-555500-FFFF00-SA**</p>								

* Design and specification are subject to change without notice.

Micro > Cap > Waterproof Cap

<ul style="list-style-type: none"> • Screw Thread • Mated IP68 			
		<p>4 Choose gender of mating pair : Male(M) / Female(F) 7 Choose plastic(1) or metal(2) items</p>	
Size	Mating Pair	Mating Style	Part Number
Micro	Receptacle	Screw Thread	CAP-WBDMSPB2
	Receptacle and Overmolded with Cable	Screw Thread	CAP-WBD 4 SMA 7

Mini > Bulkhead (Double-ended)

<ul style="list-style-type: none"> • 5 Contacts • Screw Thread • Unmated IP68 		<p>For Panel thickness Max 9.0mm</p>	
Type	Connector	Connector 1 (Female Connector / Female Contacts)	
		Connector 2 (Male Connector / Male Contacts)	
None- Certified NMEA 2000 (8A, 600V)		MN-000505-0FM-BS001	
Certified NMEA 2000 (8A, 600V)		UMN-000505-0FM-BS001	

Mini > Cable > Drop Line

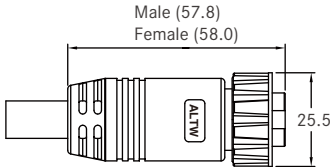
<ul style="list-style-type: none"> • 5 Contacts • Screw Thread • Mated IP68 			<p>10 Cabling Information NMEA Approved (C): (18#*1P+AL) + (15#*1P+AL) + Drain + Braid Conforming (C): (18#*1P+AL) + (16#*1P+AL) + Drain + AL+Braid **Available in 1, 2, 5, 10 M.</p>
	Connector Type	Connector (Male Connector / Male Contacts)	Connector (Female Connector / Female Contacts)
	None- Certified NMEA 2000 (8A, 30V)	MN-05AMMM-SL8 10 **	MN-05AFFM-SL8 10 **
NMEA Approved (8A, 600V)	UMN-05AMMM-SL8 10 **	-	

Mini > Cable > Double-ended Cordset

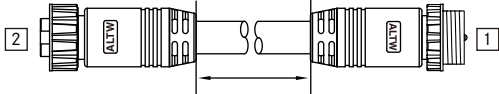
<ul style="list-style-type: none"> • 5 Contacts • Screw Thread • Mated IP68 			<p>*Available in 1, 2, 5, 10 M</p>
	Connector Type	Connector 1 (Male Connector / Male Contacts)	Connector 2 (Female Connector / Female Contacts)
	None- Certified NMEA 2000 (8A, 30V)	MN-000505-0MF-CSC*	
Certified NMEA 2000 (8A, 600V)	UMN-000505-0MF-CSC*		

* Design and specification are subject to change without notice.

Mini > Cable > Field Installable

<ul style="list-style-type: none"> • 5 Contacts • Screw Thread • Screw-in Contacts • Mated IP68 		
	<p>* Conforming to NMEA * NMEA approved</p>	
Connector Type	Connector (Male Connector / Male Contacts)	Connector (Female Connector / Female Contacts)
None- Certified NMEA 2000 (8A, 600V)	MN-05BMMB-SL7001 (Ø8 ~Ø11mm; 15AWG Max.)	MN-05BFFB-SL7001 (Ø8 ~Ø11mm; 15AWG Max.)
Certified NMEA 2000 (8A, 600V)	UMN-05BMMB-SL7001 (Ø8 ~Ø12.2mm; 15AWG Max.)	UMN-05BFFB-SL7001 (Ø8 ~Ø12.2mm; 15AWG Max.)

Mini > Cable > T-Cable

<ul style="list-style-type: none"> • 5 Contacts • Screw Thread • Mated IP68 		
	<p>* Cable: Refer to P14-4 * Available in 1, 2, 5, 10 M.</p>	
Connector Type	Connector 1 (Female Connector / Female Contacts)	Connector 2 (Male Connector / Male Contacts)
None- Certified NMEA 2000 (8A, 30V)	MN-050500-FM0-TSC*	

▾ Mini > Network Terminator > Terminator

<ul style="list-style-type: none"> • 5 Contacts • Screw Thread • With 120Ω Resistor • Mated IP68 											
<table border="1" style="width: 100%; border-collapse: collapse;"> <tr> <td style="width: 20%; text-align: center;">Connector Type</td> <td style="text-align: center;">Connector 1 (Male Connector / Male Contacts)</td> <td style="text-align: center;">Connector 1 (Female Connector / Female Contacts)</td> </tr> <tr> <td style="background-color: #e0e0e0;">None- Certified NMEA 2000 (8A, 250V)</td> <td style="text-align: center;">MNL-05BMMT-SL8001</td> <td style="text-align: center;">MNL-05BFFT-SL8001</td> </tr> <tr> <td style="background-color: #e0e0e0;">Certified NMEA 2000 (8A, 250V)</td> <td style="text-align: center;">UMN-05AMMT-SL8001</td> <td style="text-align: center;">UMN-05AFFT-SL8001</td> </tr> </table>	Connector Type	Connector 1 (Male Connector / Male Contacts)	Connector 1 (Female Connector / Female Contacts)	None- Certified NMEA 2000 (8A, 250V)	MNL-05BMMT-SL8001	MNL-05BFFT-SL8001	Certified NMEA 2000 (8A, 250V)	UMN-05AMMT-SL8001	UMN-05AFFT-SL8001		
Connector Type	Connector 1 (Male Connector / Male Contacts)	Connector 1 (Female Connector / Female Contacts)									
None- Certified NMEA 2000 (8A, 250V)	MNL-05BMMT-SL8001	MNL-05BFFT-SL8001									
Certified NMEA 2000 (8A, 250V)	UMN-05AMMT-SL8001	UMN-05AFFT-SL8001									

▾ Mini > Adaptor > T-Adaptor

<ul style="list-style-type: none"> • 5 Contacts • Screw Thread • Mated IP68 								
<table border="1" style="width: 100%; border-collapse: collapse;"> <tr> <td style="width: 20%; text-align: center;">Connector Type</td> <td style="text-align: center;">Connector 1 (Female Connector / Female Contacts)</td> </tr> <tr> <td style="background-color: #e0e0e0;"></td> <td style="text-align: center;">Connector 2 (Male Connector / Male Contacts)</td> </tr> <tr> <td style="background-color: #e0e0e0;"></td> <td style="text-align: center;">Connector 3 (Female Connector / Female Contacts)</td> </tr> </table>	Connector Type	Connector 1 (Female Connector / Female Contacts)		Connector 2 (Male Connector / Male Contacts)		Connector 3 (Female Connector / Female Contacts)		
Connector Type	Connector 1 (Female Connector / Female Contacts)							
	Connector 2 (Male Connector / Male Contacts)							
	Connector 3 (Female Connector / Female Contacts)							
None- Certified NMEA 2000 (8A, 300V)	MN-050505-FMF-TS001							
Certified NMEA 2000 (8A, 300V)	UMN-050505-FMF-TS001							

* Design and specification are subject to change without notice.

Mini > Adaptor > Elbow

<ul style="list-style-type: none"> • 5 Contacts • Screw Thread • Mated IP68 		
Type	Connector	Connector 1 (Female Connector / Female Contacts)
		Connector 2 (Male Connector / Male Contacts)
None- Certified NMEA 2000 (8A, 300V)	MN-000505-0FM-ES001	

Mini > Power Tap Tee

<ul style="list-style-type: none"> • 5 Contacts • Screw Thread • With replaceable fuse • Mated IP68 		
Type	Connector	Connector 1 (Male Connector / Male Contacts)
		Connector 2 (Female Connector / Female Contacts)
		Connector 3 (Female Connector / Female Contacts)
None- Certified NMEA 2000 (8A, 250V)	N-455000-MFF000-S001	
Certified NMEA 2000 (8A, 250V)	U-455000-MFF000-S001	

* Recommended Mating Pair for **3**

MN-04AFFM-SL8D**

Male (57.8)
Female (58.0)

Cabling Information
Conforming
(C): (18#*1P+AL) + (16#*1P+AL) + Drain + AL+Braid
**Available in 1, 2, 5, 10 M

↳ Mini > Cap > Waterproof Cap

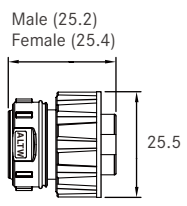
<ul style="list-style-type: none"> • 5 Contacts • Screw Thread • Mated IP68 		 <p style="text-align: center;"> Male (25.2) Female (25.4) 25.5 </p>	
		4 Choose gender of mating pair: Male(M) / Female(F)	
Size	Mating Pair	Mating Style	P/N
Mini	Receptacle and Overmolded with Cable	Screw Thread	CAP-WMN 4 SMA1

* Design and specification are subject to change without notice.

➤ Mini to Micro > Adaptor > T-Adaptor

<ul style="list-style-type: none"> • 5 Contacts • Screw Thread • Mated IP68 	
Type \ Connector	Connector 1 (Female Connector / Female Contacts)
	Connector 2 (Male Connector / Male Contacts)
	Connector 3 (Female Connector / Female Contacts)
None- Certified NMEA 2000 (4A, 60V)	NC-050505-FMF-TS001
Certified NMEA 2000 (4A, 60V)	UNC-050505-FMF-TS001

➤ Mini to Micro > I-Adaptor

<ul style="list-style-type: none"> • 5 Contacts • Screw Thread • Mated IP68 	
Type \ Connector	Connector 1 (Male Connector / Male Contacts)
	Connector 2 (Female Connector / Female Contacts)
None- Certified NMEA 2000 (4A, 60V)	NC-000505-0MF-IS001

PV AC Connectors / T-Junction Connector

Range Overview

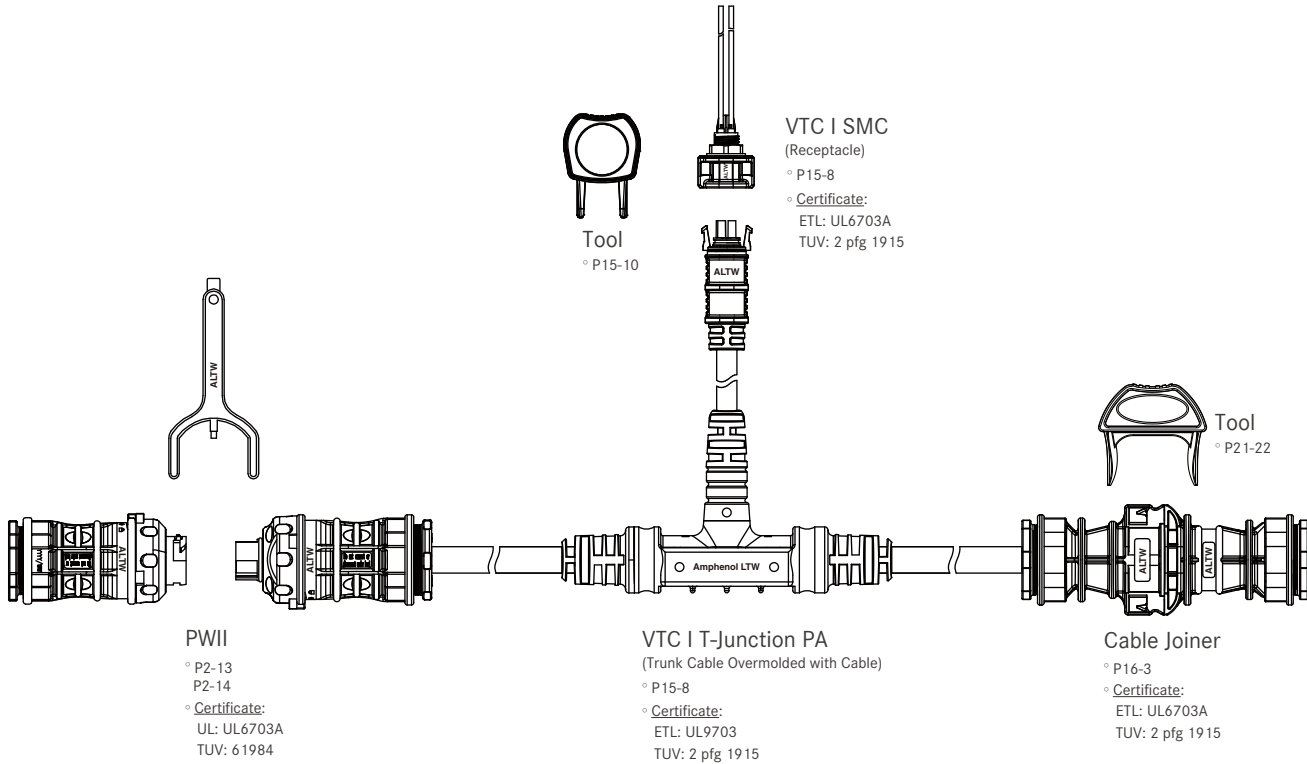

> **VTC | PT (Trunk Cable with Receptacle) & SMC**

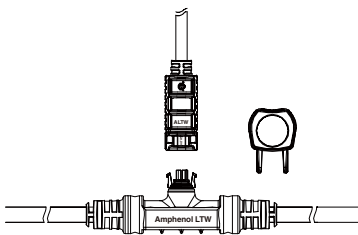

> **VTC | PA (Trunk Cable Overmolded with Cable) & SMC**

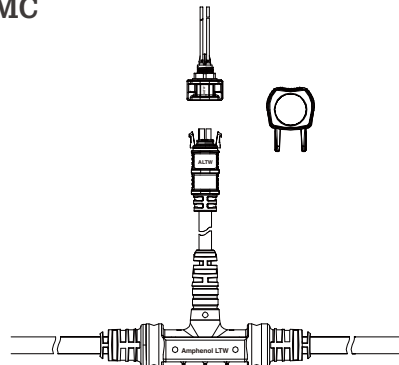

VTC | SMC

(Overmolded with Cable)

° P15-9

° Certificate:

ETL: UL6703A
TUV: 2 pfg 1915



Tool
° P15-10



Tool
° P15-13

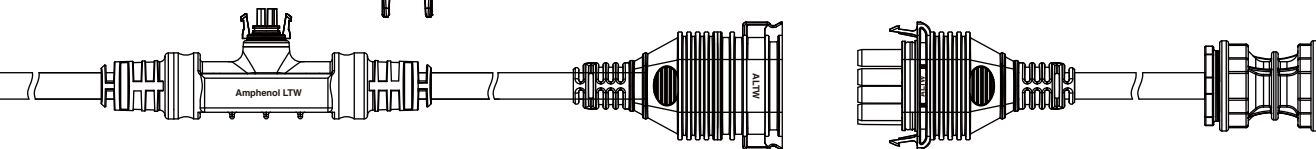

VTC | T-Junction PT
(Trunk Cable with Receptacle)

° P15-8

° Certificate:

ETL: UL9703
TUV: 2 pfg 1915

BMC

° P15-13

° Certificate:

ETL: UL6703A
TUV: 2 pfg 1915

End Cap

° P15-10

° Certificate:

ETL: UL6703A
TUV: 2 pfg 1915

> SMC | In Line



> SMC | Receptacle to Overmolded with Cable



> SMC | Receptacle to Receptacle



> BMC | In Line

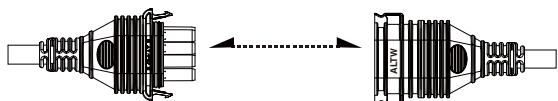

* Design and specification are subject to change without notice.

Specification

Identifications	VTC I T Junction: PT & PA (For Trunk Cable) VTC I SMC (For Drop or Receptacle) BMC
Description	Cabling System for Micro-inverter
Current Rating / Data	VTC I T Junction: Trunk Range: UL15A~30A / TUV17-25A / 3~4Pin VTC I SMC: 5A / 03~4Pin BMC: UL17A / TUV19A / 3~4Pin
Material	Contacts: Copper Alloy Connector Body: m-PPE
Waterproof Rating	IP67
Temperature Range	Ambient: -40°C ~ +85°C Upper Limited Temperature:+105°C
Contact Resistance	≤ 10mΩ
Insulation Resistance	≥ 100mΩ at DC500V
Durability	500 cycles
Breakdown Voltage	≥ DC6000V / 1 minute
Certificate	VTC I T-Junction: ETL: UL9703, TUV: 2 pfg 1915 VTC I SMC: ETL: UL6703A, TUV: 2 pfg 1915 BMC: ETL: UL6703A, TUV: 2 pfg 1915
Voltage Rating	AC 300V
More to know	Salt Spray Corrosion test: 48H Cable for Trunk: 14~10AWG or 2.5mm ² ~4mm ² Cable for Drop: 18AWG or 0.75mm ² Trunk Cable Pitch: Upon request

Ordering Information | VTC | T-Junction

1 — 2 3 4 5 — 6

Specification

>PT Type

(PT) Trunk Cable with Receptacle

>PA Type

(PA) Trunk Cable Overmolded with Cable

Number of Contacts

(3) 3 Contacts

(4) 4 Contacts

Cable Style

>UL : TCER Cable Style

>TUV : EU Cable Style

(10) 10#

(4A) 4mm² 1940 Cable

(12) 12#

(4B) 4mm² HAR Cable

(14) 14#

(2A) 2.5mm² 1940Cable

Cable pitch

(105) 1.05m pitch

(170) 1.7m pitch

(205) 2.05m pitch

* More options available

> For Trunk Cable with Receptacle (PT)

(00) SMC connector

* More options available (Upon request)

> For Trunk Cable Overmolded with Cable (PA)

+ : (Drop Cable Length) + (Cable type with or without connector)

EX. (07B) = 0.7m length + 18# without Connector

: Drop Cable Length

(07) 0.7m length

(10) 1.0m length

(15) 1.5m length * More options available

: Cable type with or without connector

>UL : TCER Cable Style

>TUV : EU Cable Style

(A) 18# With SMC connector

(E) 0.75mm² HAR Cable With SMC

(B) 18# Without Connector (Open ended)

(F) 0.75mm² HAR Cable Without SMC

(C) 16# Without Connector (Open ended)

(G) 1.0mm² HAR Cable Without SMC

(D) 14# Without Connector (Open ended)

(H) 0.75mm² 1940 Cable With SMC

(I) 0.75mm² 1940 Cable Without SMC

(J) 1.0mm² 1940 Cable Without SMC

Number of T-Junctions

008, 011, 017, ..., 999 EX. **(008)** = 8 T-Junctions

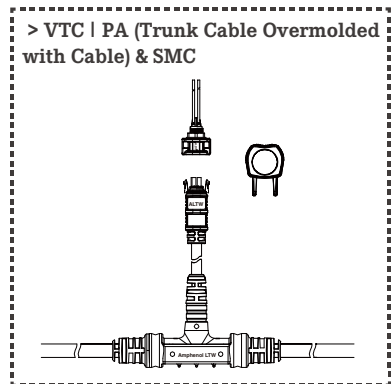
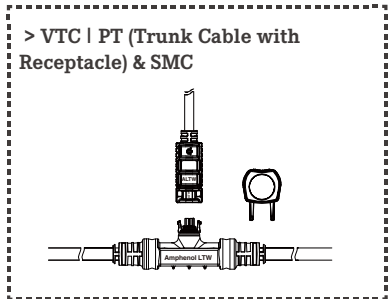

Ordering Information | VTC | SMC



Specification	
(SPS) Solar Power AC (Small size)	
Number of Contacts	
(03) 3 Contacts	(04) 4 Contacts
Connector Body (Style)	
<u>> Receptacle</u>	<u>> Overmolded with Cable</u>
(R) ALTW Rear Fastened	(A) With Strain Relief
Connector Housing Gender	
(M) Male (Plug)	(F) Female (Socket)
Contact Gender	
(M) Male	(F) Female
Assemble Style	
<u>> Receptacle</u>	<u>> Overmolded with Cable</u>
(C) Crimp Type (With Wire)	(M) Overmolded with Cable
Mating Style	
(L) 2 Points Lock (Push & Pull) (With Unlocking Tool)	
Backshell	
<u>> Receptacle</u>	<u>> Overmolded with Cable</u>
(C) Circular	(L) Straight
Waterproof Rating	
(7) IP 67	

More Information

<u>> For Receptacle</u>	<u>> For Overmolded with Cable</u>
001, 002, 003.....	(□)+(■) : Cable Type + Cable Length
001 is US Spec, 002 is EU Spec	EX. (T01) = US Cable For TCER 18# Cable + 1M
	<u>(□) : Cable Type</u>
	(T) US Cable For TCER 18# Cable
	(D) EU Cable For HAR 0.75mm ² Cable
	(E) EU Cable For 1940 0.75mm ² Cable
	<u>(■) : Cable Length</u>
	From 1M to 99M
	EX. (01) = 1M

Physical Dimension

∟ VTC | PT

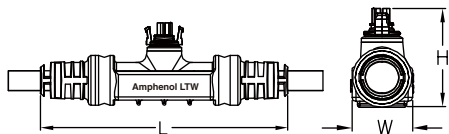

AMP \ Dimension	L	H	W
30A (UL TCER 10#)	150.0	50.1	30.6
20A (UL TCER 12#)	150.0	50.1	30.6
15A (UL TCER 14#)	150.0	50.1	30.6
25A (TUV 2pfg 1915 4mm ²)	150.0	50.1	30.6
17A (TUV 2pfg 1915 2.5mm ²)	150.0	50.1	30.6

∟ VTC | PA

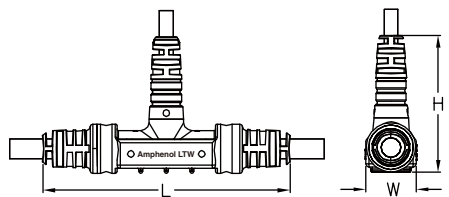

Dimension	L	H	W
30A (UL TCER 10#)	150.0	83.0	30.6
20A (UL TCER 12#)	150.0	83.0	30.6
15A (UL TCER 14#)	150.0	83.0	30.6
25A (TUV 2pfg 1915 4mm ²)	150.0	83.0	30.6
17A (TUV 2pfg 1915 2.5mm ²)	150.0	83.0	30.6

∟ SMC | Receptacle

Panel Cut-Out

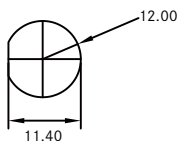

Connector Dimension

(A) Male

(B) Female

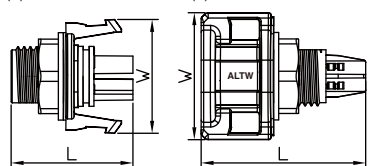

AMP \ Dimension	L		W	
Connector Gender	(B)	(A)	(B)	(A)
5A (SPS)	33.10	24.50	25.56	22.91

* Maximum Panel Thickness: 4.0mm

∟ SMC | Overmolded with Cable

(A) Male

(B) Female

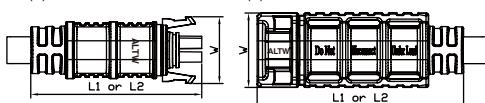

AMP \ Dimension	L 1		L 2		W	
Connector Gender	(B)	(A)	(B)	(A)	(B)	(A)
5A (SPS)	70.85	58.70	80.85	68.70	25.56	22.91



* Design and specification are subject to change without notice.

Contact Configuration

└ VTC | T-Junction

	VTC (Output)			
	3Pin		4Pin	
	US	EU	US	EU
10#	●		●	
12#	●		●	
14#	●		●	
4.0mm		●		
2.5mm		●		

└ VTC | SMC

	SPS (Input)	
	5A	
	MM or FF	MF or FM
3 Contacts		
		R C
4 Contacts		
		R C

R: receptacle
C: overmolded with cable

● 5A

Number of Contacts : 2
Ex.3 contacts (03)

Connector (Housing) Gender: 4
Male(M) or Female(F)

Contact Gender: 5
Male(M) or Female(F)

More to Choose: 6

- Crimped (C)

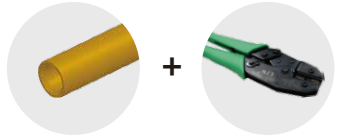

Find Our Standard Products

∟ VTC (PT) and SMC (Overmolded with Cable)

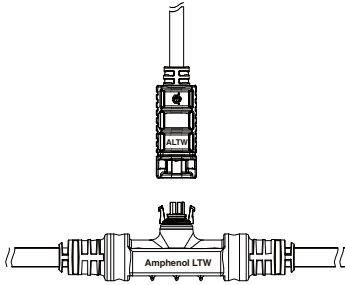

	SMC : Overmolded with cable				
		Cable type 10	AMP (Code)	Contacts 2	Female Connector (F) Male Contacts (M)
	US (UL TC-ER cable)	TCER 18# cable (T)	5A(SPS)	03,04	SPS- 2 AFMM-LL7T**
	EU (TUV 2pfg1940 cable)	HAR 0.75 mm ² cable (D) 1940 0.75 mm ² cable (E)		03	SPS-03AFMM-LL7 10 **
(PT) Trunk Cable with Receptacle					
	Wire Size 3	Contacts 2	T-Junction Pitch 4	Number of T-Junction 6	P/N
US (UL TCER cable)	10# (30A) (10) 12# (20A) (12) 14# (15A) (14)	03,04	1.05M (105) 1.7M (170) 2.05M (205)	001	PT- 2 3 4 -00- 6
EU (TUV 2pfg1940 cable)	4mm ² (4A/4B) (25A) 2.5mm ² (2A) (17A)	03		075	PT-3- 3 4 -00- 6

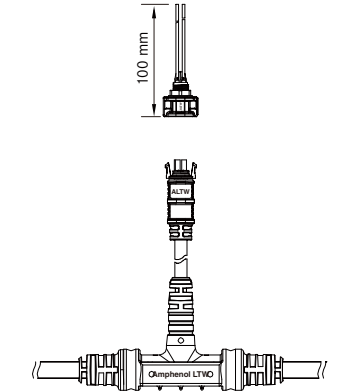
∟ VTC (PA) and SMC (Receptacle)

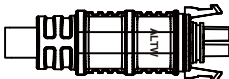

	SMC : Receptacle						
		AMP (Code)	Contacts 2	Female Connector (F) Male Contacts (M)			
	US (UL TC-ER Cable)	5A (SPS)	03,04	SPS- 2 RFMC-LC7001			
	EU (TUV 2pfg1940 Cable)		03	SPS- 2 RFMC-LC7002			
(PA) Trunk Cable Overmolded With Cable							
	Wire Size 3	Contacts 2	T-Junction Pitch 4	Number of T-Junction 6	Drop Cable Length + Cable type 5	P/N	
US (UL TCER cable)	10# (30A) (10) 12# (20A) (12) 14# (15A) (14)	03,04	1.05M (105) 1.7M (170) 2.05M (205)	001	0.7M (07) 1.0M (10) 1.5M (15)	18#with SMC Conn 18#without Conn. 16#without Conn. 14#without Conn.	PA- 2 3 4 5 6
EU (TUV 2pfg1940 Cable)	4mm ² (4A/4B) (25A) 2.5mm ² (2A) (17A)	03		075	0.75mm ² with SMC Conn. 0.75mm ² without Cor 1.0mm ² without Con	PA-3 3 4 5 6	

* Design and specification are subject to change without notice.



∟ SMC > In-line

<ul style="list-style-type: none"> • Male Connector (Housing) • Female Contacts • Safety Lock (Unlock tool needed) 		<p>Overmolded with Cable -----></p>  <p>Waterproof Cap CAP-WSMMFLA1</p> <p>**cable length:01-99m</p>		<p>Overmolded with Cable</p>  <p>Waterproof Cap CAP-WSMMMLA1</p> <p>**cable length:01-99m</p>	
	Contacts 2	Cable type 10	Male Connector (M) Female Contacts (F)	Female Connector (F) Male Contacts (M)	
5A(SPS)	03,04	T-TCER 18# cable (US)	SPS- 2 AMFM-LL7**	SPS- 2 AFMM-LL7**	
	03	D-HAR 0.75mm ² Cable (EU)	SPS-03AMFM-LL7 10 **	SPS-03AFMM-LL7 10 **	
E-1940 0.75mm ² Cable (EU)					

∟ SMC > Receptacle and Mating Pair

<ul style="list-style-type: none"> • Male Connector (Housing) • Female Contacts • Safety Lock (Unlock tool needed) 		<p>Receptacle -----></p>  <p>Waterproof Cap CAP-WSMMFLA1</p>		<p>Overmolded with Cable</p>  <p>Waterproof Cap CAP-WSMMMLA1</p> <p>**cable length:01-99m</p>	
AMP (Code)	Contacts 2	Cable type 10	Male Connector (M) Female Contacts (F)	Female Connector (F) Male Contacts (M)	
5A(SPS)	03,04	T-TCER 18# wire (US)	SPS- 2 RMFC-LC7001	SPS- 2 AFMM-LL7**	
	03	D-HAR 0.75mm ² wire (EU)	SPS-03RMFC-LC7002	SPS-03AFMM-LL7 10 **	
E-1940 0.75mm ² wire (EU)					

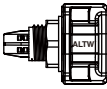
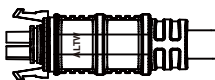
∟ SMC > Receptacle and Mating Pair

<ul style="list-style-type: none"> • Female Connector (Housing) • Male Contacts • Safety Lock (Unlock tool needed)  			<p>Receptacle </p> <p>Overmolded with Cable </p>	
<p>Waterproof Cap CAP-WSMMLA1 </p> <p>Waterproof Cap CAP-WSMMFLA1 </p> <p>**cable length:01-99m</p>				
AMP (Code)	Contacts 2	Cable type 10	Female Connector (F) Male Contacts (M)	Male Connector (M) Female Contacts (F)
5A(SPS)	03,04	T-TCER 18# wire (US)	SPS- 2 RFMC-LC7001	SPS- 2 AMFM-LL7**
	03	D-HAR 0.75mm ² wire (EU)	SPS-03RFMC-LC7002	SPS-03AMFM-LL7 10 **
		E-1940 0.75mm ² wire (EU)		

∟ Accessories > Waterproof Cap

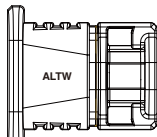
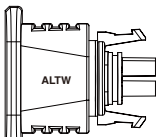
 <p>Mating Pair (Gender): Male Connector</p>		 <p>Mating Pair (Gender): Female Connector</p>		
Size	Mating Pair	Mating Pair (Gender)	Mating Style	Part Number
SMC	Receptacle and Overmolded with Cable	Male Connector	2 point lock bayonet	CAP-WSMMFLA 1
	Receptacle and Overmolded with Cable	Female Connector	2 point lock bayonet	CAP-WSMMLA 1

∟ Accessories > End-Cap

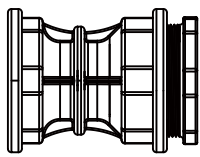
	
Cable OD.	Part Number
16~12mm	CAP-WTCASMA 1
12~10mm	CAP-WTCASMA2
10~08mm	CAP-WTCASMA3

∟ Accessories > Tool

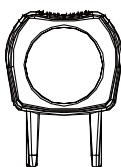
	
Size	Part Number
SMC	ULT-SSMC-01

* Design and specification are subject to change without notice.

Ordering Information | BMC



Specification

(SPB) Solar Power For Big MC
(17A: UL US Market ; 19A: TUV EU Market)

Number of Contacts

(3) 3 Contacts (4) 4 Contacts

Connector Body (Style)

> Overmolded with Cable

(A) With Strain Relief

Connector Housing Gender

(M) Male (Plug) (F) Female (Socket)

Contact Gender

(M) Male (F) Female

Assemble Style

> Overmolded with Cable

(M) Overmolded with Cable

Mating Style

(L) 2 Points Lock (Push & Pull)
(With Unlocking Tool)

Backshell

> Overmolded with Cable

(L) Straight

Waterproof Rating

(7) IP 67

More Information

> For Overmolded with Cable

(□)+(■) : Cable Type + Cable Length

EX. (C01) = EU Cable For HAR 4mm² Cable + 1M

(□) : Cable Type

(■) : Cable Length

(R) UL Cable For TCER 12# Cable From 1M to 99M

(C) EU Cable For HAR 4mm² Cable EX. (01) = 1M

(L) EU Cable For 1940 4mm² Cable

Physical Dimension

└ BMC | Overolded with Cable

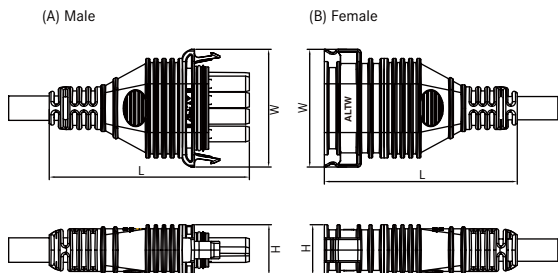

Connector Gender	L		W		H	
	(B)	(A)	(B)	(A)	(B)	(A)
17A (SPB)	94.95	98.5	58.0	58.0	25.0	25.0
19A (SPB)	94.95	98.5	58.0	58.0	25.0	25.0

* 17A: Comply to UL standard for USA Dimensions are shown in millimeters
 19A: Comply to TUV standard for Europe

Contact Configuration

└ BMC

	SPB (Output)			
	17A		19A	
	MM or FF	MM or FF	MM or FF	MM or FF
3 Contacts				
	C		C	
4 Contacts				
	C		C	

* 17A: Comply to UL standard for USA
 19A: Comply to TUV standard for Europe

Number of Contacts : 2
 Ex.3 contacts (03)

Connector (Housing) Gender: 4
 Male(M) or Female(F)
 • For BMC & SMC

Contact Gender: 5
 Male(M) or Female(F)
 • For BMC & SMC

More to Choose: 6
 • Crimped (C)

* Design and specification are subject to change without notice.

Find Our Standard Products

∟ BMC > Receptacle and Mating Pair

- Male Connector (Housing)
- Female Contacts
- Safety Lock (Unlock tool needed) 

Receptacle

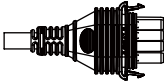

Waterproof Cap
CAP-WBMCFLD 1



**cable length:01-99m

Overmolded with Cable

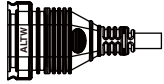

Waterproof Cap
CAP-WBMCMLD 1



**cable length:01-99m

AMP (Code)	Contacts 2	Cable type 10	Male Connector (M) Female Contacts (F)	Female Connector (F) Male Contacts (M)
17A(SPB)	03,04	R-TCER 12# cable (US)	SPB- 2 AMFM-LL7R**	SPB- 2 AFMM-LL7R**
19A(SPB)	03	C-HAR 4.0 mm ² cable (EU)	SPB-03AMFM-LL7 10 **	SPB-03AFMM-LL7 10 **
		L-1940 4.0 mm ² cable (EU)		

∟ Accessories > Waterproof Cap

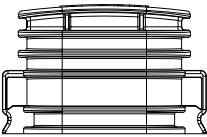

Mating Pair (Gender): Male Connector



Mating Pair (Gender): Female Connector

Size	Mating Pair	Mating Pair (Gender)	Mating Style	Part Number
BMC	Receptacle and Overmolded with Cable	Male Connector	2 point lock bayonet	CAP-WBMCFLD 1
	Receptacle and Overmolded with Cable	Female Connector	2 point lock bayonet	CAP-WBMCMLD 1

∟ Accessories > Tool

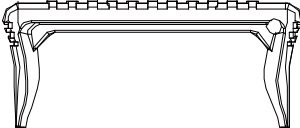

Size	Part Number
BMC	ULT-SBMC01

* Design and specification are subject to change without notice.

Cable Joiner Connector



Range Overview

∟ **Field Installable**

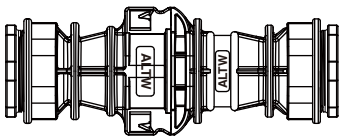

° Certificate:
ETL: UL6703A
TUV: 2 pfg 1915

M32



M20

Specification

Identifications (Cable OD)	6~10 mm, 8~10mm, 10~12mm, 12~16mm
Material	M20: Nylon M32: PPE
Waterproof Rating	IP67
Temperature Range	Field Installable: PPE: -40°C~105°C Nylon: -40°C~105°C

Ordering Information

	1	2	3	4	5	6	7
Specification							
(CX) Cable Joiner							
No. of Conductor							
(00) None							(04) 4 Conductors
Connector Body (Style)							
(B) For Cable without Strain Relief							
AWG (Terminal)							
(B) 14~16AWG							(C) 10~12AWG
(O) No Terminal							
Size							
(M20) M20							
(M32) M32							
Waterproof Rating							
(7) IP 67							
Jacket OD							
(001) 12mm~16mm							
(002) 10mm~12mm							
(003) 8mm~16mm							

Physical Dimension

▾ Cable Joiner

Connector Dimension

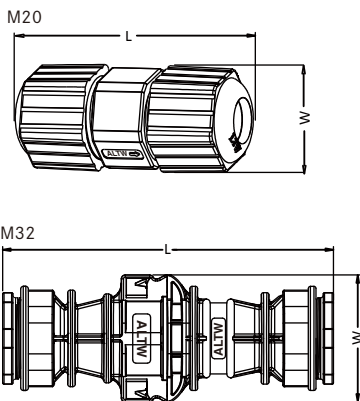

Size \ Dimension	L	W	AWG (Terminal)	Cable OD
M20	56.0	25.4	-	6~10
M32	130.2	50.0	-	12~16
	130.2	50.0	-	10~12
	130.2	50.0	-	8~10
	130.2	50.0	14~16	8~10
	130.2	50.0	10~12	12~16
	130.2	50.0	10~12	10~12

Dimensions are shown in millimeters

* Design and specification are subject to change without notice.

Find Our Standard Products

▾ Cable Joiner

M20

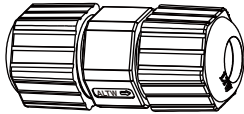

M32

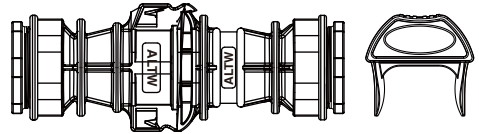

- UV Resistant
- Unlock with tool
- Butt splice terminals optional
- ETL: UL6703A
- TUV: 2 pfg 1915

Size	Awg (Terminal)	Part Number
M20	Without Terminal (0)	CX-00B0M20-700 1
M32	14~16 (B)	CX-04BBM32-700 1
	10~12 (C)	CX-04BCM32-700*
	Without Terminal (0)	CX-00B0M32-700*

* M32: Choose Cable OD: 8mm ~ 10mm / 10mm ~ 12mm / 12mm ~ 16mm

▾ Accessories > Unlock Tool

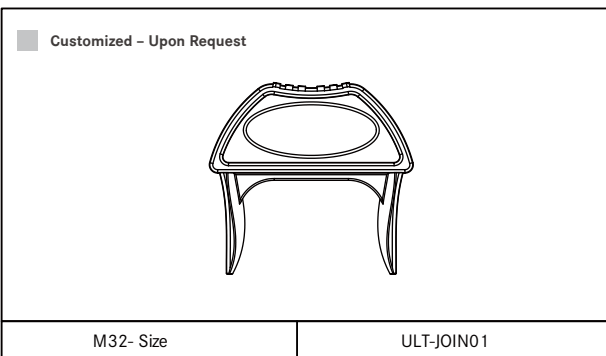

Cable Gland



Range Overview

∟ Plastic Cable Gland

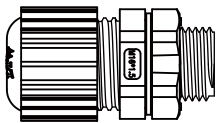
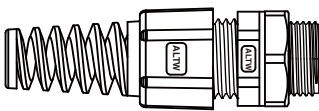

∟ Metal Cable Gland

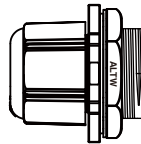

Specification

Identifications	1"-20 UNF Metal, M8, M12, M16, M20, M25, M32, M40 PG7, PG9, PG11, PG13, PG16, PG29
Material	Connector Body (Plastic): Nylon 66, UL Recognized UV Resistant Connector Body (Metal): Zinc Alloy, Nickel plated (1"-20 Only)
Waterproof Rating	IP67~68
Temperature Range	Receptacle: -20°C ~ +105°C
More to know	Without Strain Relief / With Strain Relief Mating Style: Screw Thread

Ordering Information

	1 — 2 3
Specification	
(CSG) Cable Gland	
Screw Thread Type	
(20E) 1"-20 UNF Metal	(07G) PG7
(08M) M8	(09G) PG9
(12M) M12	(11G) PG11
(16M) M16	(13G) PG13.5
(20M) M20	(16G) PG16
(25M) M25	(29G) PG29
(32M) M32	
(40M) M40	
More information	
(001), (002), (003)...	

* Design and specification are subject to change without notice.

Physical Dimension

∟ Without Strain Relief

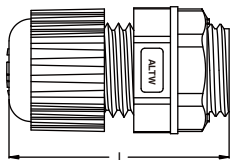

∟ With Strain Relief

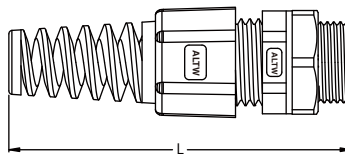

Size	Dimension (Without Strain Relief)		Dimension (With Strain Relief)		Maximum Panel Thickness
	Short	Long	Short	Long	
PG7	-	30.0mm	-	60.0mm	3.0mm
PG9	-	45.0mm	-	78mm	7.5mm
PG11	-	48.3mm	-	79.1mm	6.0mm
PG13	-	49.6mm	-	86.6mm	6.2mm
PG16	45.0mm	49.6mm	81.6mm	86.6mm	4.5mm (Short) 6.0mm (Long)
PG29	-	52.5mm	-	-	6.0mm
M8	22.0 mm	-	-	-	-
M12	30.0 mm	42.2mm	-	60.0mm	3.0mm
M16	40.0mm	45.0mm	75.3mm	78.0mm	3.0mm (Short) 7.5mm (Long)
M20	36.7mm	43.7mm	79.6 mm	86.6mm	6.2mm
M25	45.0mm	52.1mm	89.0 mm	96.0mm	6.2mm
M32	47.5 mm	52.5mm	-	-	6.0mm
M40	-	60.0mm	-	-	9.0mm
1"-20 UNF Metal	35.0mm		-	-	5.0mm

Find Our Standard Products

▾ Plastic Cable Gland

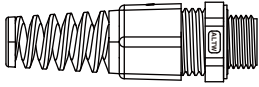

With Strain Relief / Without Screw Nut

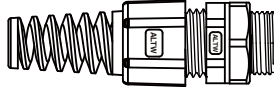

With Strain Relief / With Screw Nut

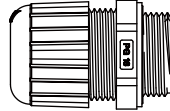

Without Strain Relief / Without Screw Nut

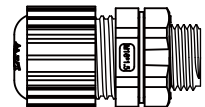

Without Strain Relief / With Screw Nut

	Thread Style	Cable OD	Part Number	Cable Information 3
PG Thread	PG7	4.5~6.5	CSG-07G00 3	001-Without strain relief ,Black 002-Without strain relief ,Gray 003-With strain relief ,Black 004-With strain relief ,Gray 005-Without strain relief ,Gray For Knock Hole
	PG9	6.0~10.0	CSG-09G00 3	001-Without strain relief ,Black 002-Without strain relief ,Gray 003-With strain relief ,Black 004-With strain relief ,Gray 005-Without strain relief ,Gray For Knock Hole
	PG11	6.0~10.0	CSG-11G00 3	001-Without strain relief ,Black 002-Without strain relief ,Gray 003-With strain relief ,Black 004-With strain relief ,Gray
	PG13	10.0~14.0	CSG-13G00 3	001-Without strain relief ,Black 002-Without strain relief ,Gray 003-With strain relief ,Black 004-With strain relief ,Gray
	PG16	10.0~14.0	CSG-16G00 3	001-Without strain relief ,Black (Long Body) 002-Without strain relief ,Gray (Long Body) 003-With strain relief ,Black (Long Body) 004-With strain relief ,Gray (Long Body)
				006-Without strain relief ,Gray (Short Body),without Screw Nut 007-Without strain relief ,Black (Short Body),without Screw Nut 008-With strain relief ,Black (Short Body),without Screw Nut 009-With strain relief ,Gray (Short Body)
				5.5~7.6
		Max 6.5	CSG-16G010	Without strain relief ,Black (Long Body) For RJ Cable Use
	PG29	16~22	CSG-29G00 3	001-Without strain relief ,Black 002-Without strain relief ,Gray
		18~25	CSG-29G00 3	003-Without strain relief ,Black 004-Without strain relief ,Gray

* Design and specification are subject to change without notice.

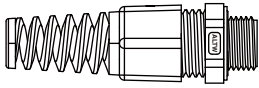

With Strain Relief / Without Screw Nut

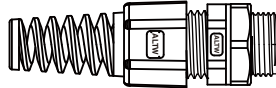

With Strain Relief / With Screw Nut

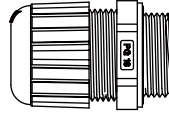

Without Strain Relief / Without Screw Nut

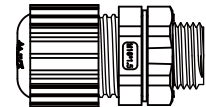

Without Strain Relief / With Screw Nut

	Thread Style	Cable OD	Part Number	Cable Information 3
Metric Thread	M8	2.5~3.0	CSG-08M00 3	001-Without strain relief,Black 002-Without strain relief ,Gray
	M12	4.5~6.5	CSG-12M00 3	001-Without strain relief,Black 002-Without strain relief ,Gray 003-With strain relief ,Black 004-With strain relief ,Gray 005-Without strain relief ,Black (Short Body),V0 F1 006-Without strain relief ,Black (Long Body),V0 F1
	M16	6.0~10.0	CSG-16M00 3	001-Without strain relief ,Black (Long Body) 002-Without strain relief ,Black (Long Body), UV Resistant 003-Without strain relief ,Gray (Long Body) 004-Without strain relief ,Black (Short Body) 005-Without strain relief ,Gray (Short Body) 006-With strain relief ,Black (Long Body) 007-With strain relief ,Gray (Long Body) 008-With strain relief ,Black (Short Body),without Screw Nut 009-With strain relief ,Gray (Short Body),without Screw Nut
	M20	10.0~14.0	CSG-20M00 3	001-Without strain relief ,Black (Long Body) 002-Without strain relief ,Black (Short Body),without Screw Nut 003-Without strain relief ,Gray (Long Body) 004-Without strain relief ,Gray (Short Body),without Screw Nut 005-With strain relief ,Black (Long Body) 006-With strain relief ,Gray (Long Body) 007-With strain relief ,Black (Short Body),without Screw Nut 008-With strain relief ,Gray (Short Body),without Screw Nut
	M25	13.0~18.0	CSG-25M00 3	001-Without strain relief ,Gray (Long Body) 002-Without strain relief ,Black (Short Body),without Screw Nut 003-Without strain relief ,Black (Long Body) 004-Without strain relief ,Gray (Short Body),without Screw Nut 005-With strain relief ,Black (Long Body) 006-With strain relief ,Gray (Long Body) 007-With strain relief ,Black (Short Body),without Screw Nut 008-With strain relief ,Gray (Short Body),without Screw Nut
	M32	16.0~22	CSG-32M00 3	001-Without strain relief ,Black (Long Body) 002-Without strain relief ,Gray (Long Body) 003-Without strain relief ,Black (Short Body),without Screw Nut 004-Without strain relief ,Gray (Short Body),without Screw Nut
		18.0~25.0	CSG-32M00 3	005-Without strain relief ,Black (Long Body) 006-Without strain relief ,Gray (Long Body) 007-Without strain relief ,Black (Short Body),without Screw Nut 008-Without strain relief ,Gray (Short Body),without Screw Nut
	M40	20~25	CSG-40M00 3	001-Without strain relief ,Black (Long Body) 002-Without strain relief ,Gray (Long Body)
		24~32	CSG-40M00 3	003-Without strain relief ,Black (Long Body) 004-Without strain relief ,Gray (Long Body)

↳ **Metal Cable Gland**

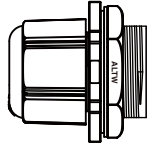

	Thread Style	Cable OD	Part Number	Cable Information
Unified Screw Thread	1"-20 UNF Metal	5.5~7.0	CSG-20E001	Without strain relief, Silver
		7.8~9.3	CSG-20E002	Without strain relief, Silver

* Design and specification are subject to change without notice.

Vent Connector



Range Overview

Ordering Information

Receptacle

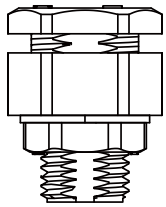

M12*1.25

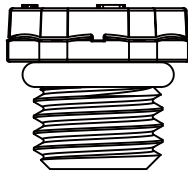

M12*1.5

1 - 2 3

Specification

(VENT) Vent

Type

(BD) M12 x 1.25 (BJ) M12 x 1.5

More Information

(001), (002)

Specification

Identifications	M12 Vent Connector
Material	PBT+PC (M12 x 1.25) / M-PPE (M12 x 1.5)
Waterproof Rating	IP67 (M12 x 1.25) / IP69K (M12 x 1.5)
Temperature Range	Receptacle: -20°C ~ +105°C (M12 x 1.25) -40°C ~ +105°C (M12 x 1.5)
More to know	Thermal Shock: EIA 364-32 or IEC 60512-11d UV Resistant: F1

Physical Dimension

Receptacle

M12*1.25
Panel Cut-Out

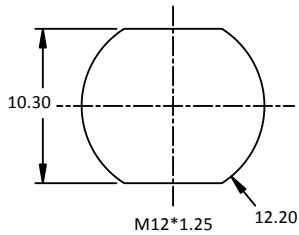

Connector Dimension

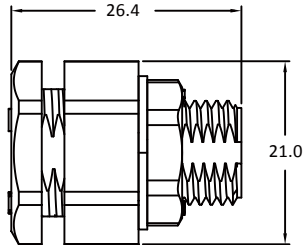

M12*1.5
Panel Section

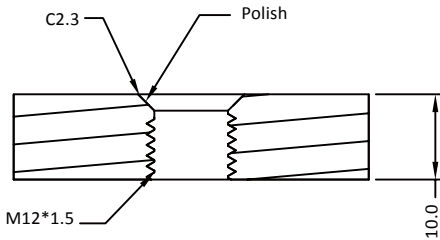

Connector Dimension

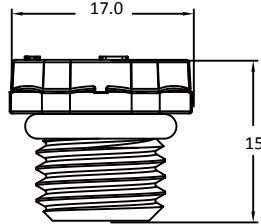

Find Our Standard Products

Receptacle

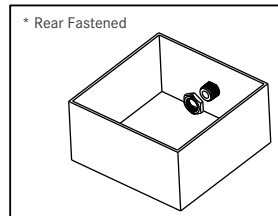
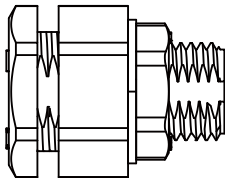

M12*1.25

VENT-BD001
VENT-BD002

Different air permeability: 1.VENT-BD001:Air permeability: 12sec/100cm³
2.VENT-BD002:Air permeability: 10sec/100cm³

Receptacle

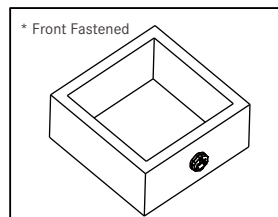
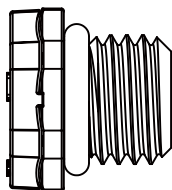

M12*1.5

VENT-BJ001

Note: VENT-BJ001:Air permeability: 10sec/cm³

* Design and specification are subject to change without notice.

RBL Connector



- Haptic
- Blind Mating
- Push-to-Connector
- Easy and Fast Disconnect

Range Overview

∨ In-line

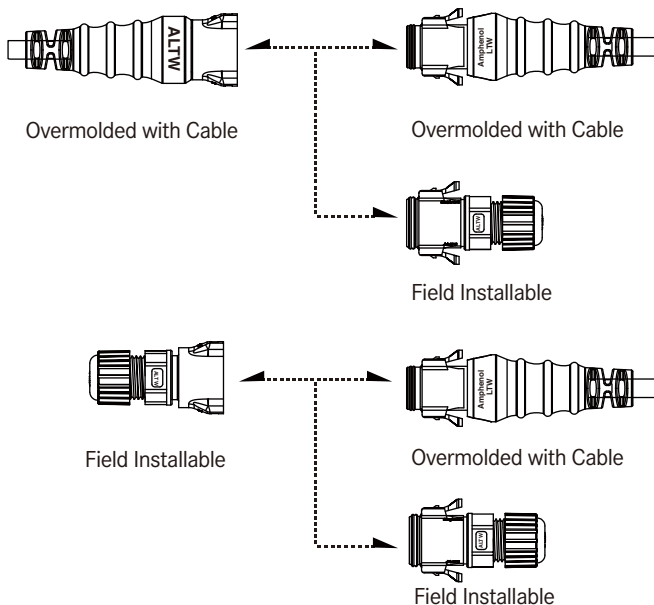

∨ Receptacle and Mating Pair

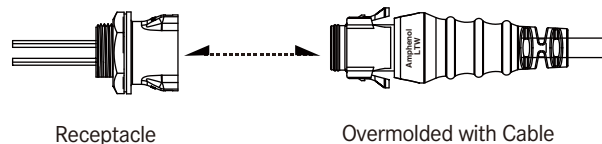

∨ Receptacle to Field Installable

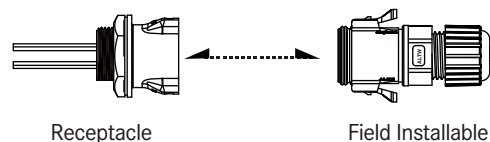

∨ Accessories

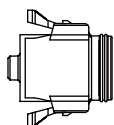

Waterproof Cap
See page 20-6

Specification

Identifications	C Size (Middle Size: 13/16"-28 UNS)
Description	Receptacle Overmolded with Cable Field Installable
Current Rating / Data	5A, 10A
Material	Contacts: Copper Alloy, Tin Plated & Gold Plated (Selective) Connector Body (Housing) : m-PPE,540Z,BK
Waterproof Rating	IP67(Mate Waterproof)
Temperature Range	Receptacle: -40°C ~ +105°C Overmolded with Cable: -20°C~80°C Field Installable: -40°C~ +105°C
Contact Resistance	≤ 10mΩ
Insulation Resistance	≥ 100mΩ at DC500V
Durability	1000 cycles
Breakdown Voltage	≥ AC1000V / 1 minute
More to know	Salt Spray Corrosion Test: 4H Standard cable length: 01~99M

* Design and specification are subject to change without notice.

Ordering Information

	1	2	3	4	5	6	7	8	9	10
Specification / Current Rating										
<u>>Middle size:13 / 16"-28 UNS</u>										
(SCD) 5A										
(SCB) 10A										
Number of Contacts										
04, 06										
EX. (04) = 4 Contacts										
Connector Body (Style)										
<u>> For Receptacle</u>			<u>> For Ovremolded with Cable</u>				<u>> For Field installable</u>			
(R) Rear Fastened			(M) With Strain Relief				(F) Without Strain Relief			
Connector (Housing) Gender										
(M) Male					(F) Female					
Contact Gender										
(S) Male (Stamp)										
(P) Female (Stamp)										
* Choose the Plating to Tin or Gold.										
Assemble Style										
<u>> For Receptacle</u>			<u>> For Overmolded with Cable</u>							
(S) Solder Type			(C) Crimp Type							
			<u>> For Field Installable</u>							
			(C) Crimp Type							
Mating Style										
(R) Snap-in with										
Backshell										
<u>> For Receptacle</u>			<u>> For Overmolded with Cable</u>				<u>> For Field</u>			
(C) Circular			(L) Straight				<u>Installable</u>			
(S) Square Flange							(L) Straight			
Waterproof Rating										
(7) IP 67										
More information										
<u>> For Receptacle with Wireharness</u>					<u>> For Overmolded with Cable</u>					
<input type="checkbox"/>)+(<input type="checkbox"/>) : Wire Type + Wire Length					<input type="checkbox"/>)+(<input type="checkbox"/>) : Cable Type + Cable					
EX. (A10) = UL1015 Wire + 10 CM					Length					
<u><input type="checkbox"/>) : Wire Type</u>		<u><input type="checkbox"/>) : Wire Length</u>		<u><input type="checkbox"/>) : Cable Type</u>		<u><input type="checkbox"/>) : Cable Length</u>				
(A) UL1015 Wire		(10) 10CM		(A) UL2464 Cable		From 1M to 99M				
		(30) 30CM		(B) UL2586 Cable		EX.(01) = 1M				
				(C) Power Cable(TC-ER)						

Physical Dimension

Receptacle

A Backshell: Circular **B** Backshell: Square Flange

Panel Cut-Out

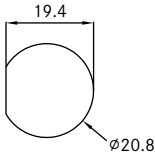

Connector Dimension

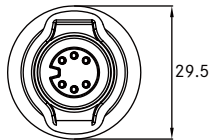
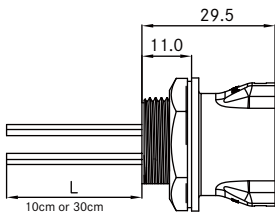

Panel Cut-Out

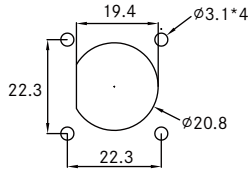

Connector Dimension

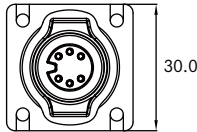
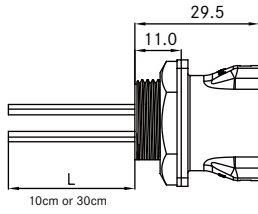

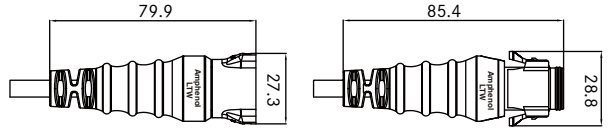

Overmolded with Cable

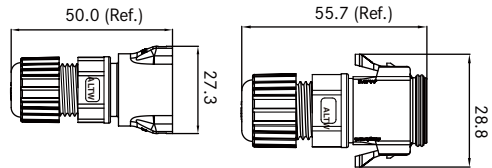

Field Installable



Contact Configuration

	Middle Size (C)			
	5A		10A	
4 5	MM or FF	MF or FM	MM or FF	MF or FM
2Pin				
3Pin				
4Pin				
			R C F	
5Pin				
6Pin				
	R C F			

R: receptacle
C: overmolded with cable
F: Field Installable

● 5A (SCD) **1**
● 10A (SCB)

Contact Number: **2**
Contacts (06), (04)

Connector (Housing) Gender: **4**
Male(M) or Female(F)

Contact Gender: **5**
Male(M) or Female(F)

More to Choose: **6**

● Solder (S) ● Crimp (C)

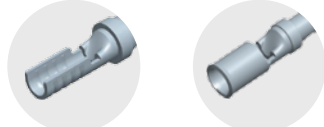

* More available: 1. The plating to gold or tin
2. Plated thickness

1 — **2** **3** **4** **5** **6** — **7** **8** **9** **10**

* Design and specification are subject to change without notice.

Find Our Standard Products

∟ Middle Size: 13/16"-28 UNS > Receptacle and Mating Pair

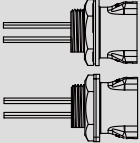
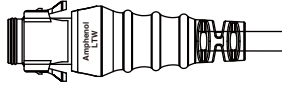
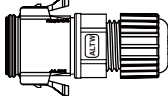
<ul style="list-style-type: none"> ● Female Connector ● Snap-in with Latch 		<p>Receptacle</p>  <p>* Receptacle With Wireharness: A10 - 10cm; A30 - 30cm ** Choose the cable length:01-99</p>	<p>Overmolded with Cable</p>  <p>** Select cable length from 01~99m</p>	<p>Field Installable</p> 
Current Rating (Code)	Contacts	Female Connector (F)	Male Connector (M)	Male Connector (M)
5A (SCD)	06	SCD-06RFPS-RC** SCD-06RFPS-RS**	SCD-06MMSC-RL7A**	SCD-06FMSC-RL7001
10A (SCB)	04	SCB-04RFPS-RC** SCB-04RFPS-RS**	SCB-04MMSC-RL7A**	SCB-04FMSC-RL7001

∟ Middle Size: 13/16"-28 UNS > In-line

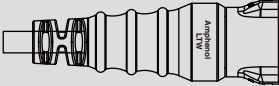
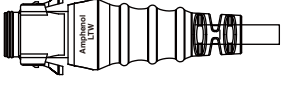
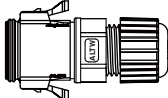
<ul style="list-style-type: none"> ● Female Connector ● Snap-in with Latch 		<p>Overmolded with Cable</p>  <p>** Select cable length from 01~99m</p>	<p>Overmolded with Cable</p>  <p>** Select cable length from 01~99m</p>	<p>Field Installable</p> 
Current Rating (Code)	Contacts	Female Connector (F)	Male Connector (M)	Male Connector (M)
5A (SCD)	06	SCD-06MFPC-RL7A**	SCD-06MMSC-RL7A**	SCD-06FMSC-RL7001
10A (SCB)	04	SCB-04MFPS-RS**	SCB-04MMSC-RL7A**	SCB-04FMSC-RL7001

∨ Middle Size: 13/16"-28 UNS >In-line

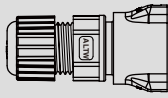
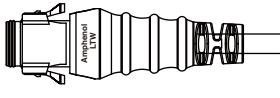
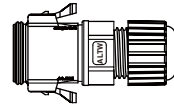
<ul style="list-style-type: none"> ● Female Connector ● Snap-in with Latch 		Field Installable →	Overmolded with Cable →	Field Installable
				
		** Select cable length from 01-99m		
Current Rating (Code)	Contacts	Female Connector (F)	Male Connector (M)	Male Connector (M)
5A (SCD)	06	SCD-06FFPC-RL7001	SCD-06MMSC-RL7A**	SCD-06FMSC-RL7001
10A (SCB)	04	SCB-04FFPC-RL7001	SCB-04MMSC-RL7A**	SCB-04FMSC-RL7001

∨ Accessories > Waterproof Cap

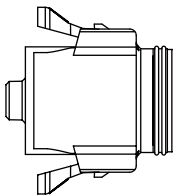
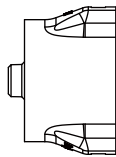
			
Mating Pair (Gender): Female			
			
Mating Pair (Gender): Male			
5 Choose Connector Gender Male (M) or Female (F)			
Size	Mating Pair	Mating Style	Part Number
13/16"-28 UNS	Receptacle	Snap In With Latch	CAP-WAC 5 RMA1
	Overmolded with Cable	Snap In With Latch	
	Receptacle and Overmolded with Cable	Snap In With Latch	

X-Lok Connector



- Haptic
- Blind Mating
- Push-to-Connector
- Easy and Fast Disconnect

Range Overview

Receptacle to Overmolded with Cable

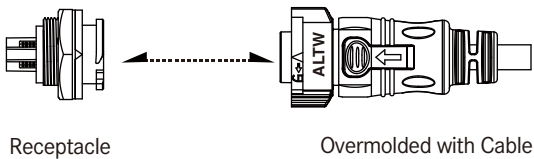

In Line

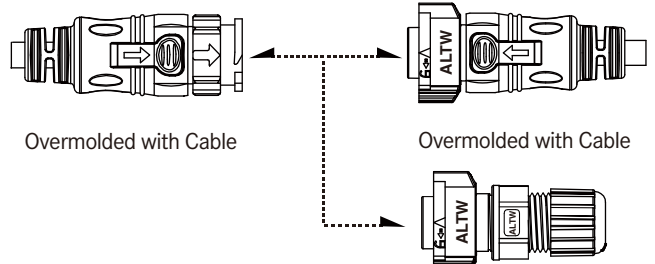

Receptacle to Field Installable

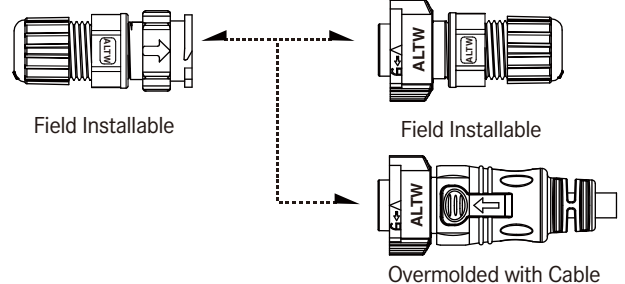
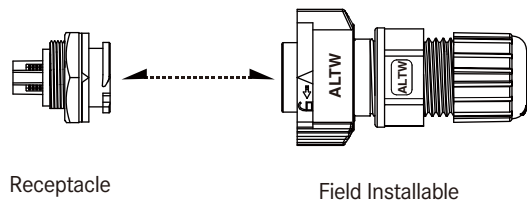

Specification

Identifications	C Size (Middle Size: 13/16"-28 UNS)
Description	Receptacle Overmolded with Cable Field Installable
Current Rating / Data	20A
Material	Contacts: Copper Alloy, Tin & Gold Plated Connector Body (Housing) : Nylon+GF, UL Recognized
Waterproof Rating	IP67
Temperature Range	Receptacle: -40°C ~ +105°C Overmolded with Cable: -20°C~80°C Field Installable: -40°C~ +105°C
Contact Resistance	≤ 10mΩ
Insulation Resistance	≥ 100mΩ at DC500V
Durability	500 cycles
Breakdown Voltage	≥ AC 1600V / 1 minute
More to know	Salt Spray Corrosion Test: 12H Standard cable length: 01~99M

Ordering Information

1 - 2 3 4 5 6 - 7 8 9 10

Specification / Current Rating
(SCC) 20A

Number of Contacts

03

EX. **(03)** = 3 Contacts
Connector Body (Style)

> For Receptacle

(R) Rear Fastened

> For Overmolded with Cable

(M) With Strain Relief

> For Field installable

(F) Without Strain Relief

Connector (Housing) Gender
(M) Male Connector

(F) Female Connector

Contact Gender
(S) Male (Stamp)

(P) Female (Stamp)

Assemble Style

> For Receptacle

(S) Solder Type

> For Overmolded with Cable

(S) Solder Type

> For Field Installable

(C) Crimp Type

Mating Style
(Q) Push Lock (Sprind loaded nut)

Backshell

> For Receptacle

(C) Circular

> For Overmolded with Cable

(L) Straight

(R) Right Angle (Avaible soon)

> For Field Installable

(L) Straight

Waterproof Rating
(7) IP 67

More Information

> For Receptacle

(001), (002).....

Without Cable :

Different Versions

> For Overmolded with Cable

(□)+(■) : Cable Type + Cable Length

EX. **(A01)** = UL2464 Cable + 1M

(□) : Cable Type

(A) UL2464 Cable

(B) UL2586 Cable

(C) Power Cable(TC-ER)

(■) : Cable Length

From 1M to 99M

EX. **(01)** = 1M

Physical Dimension

Receptacle

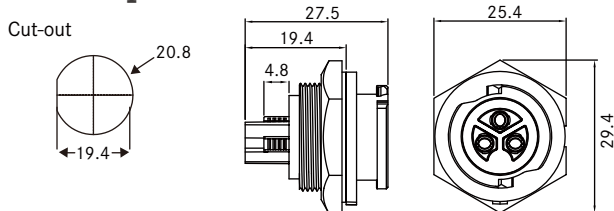

* Maximum Panel Thickness: 4.2mm | Solder PIN: 12Awg ~ 14Awg

Overmolded with Cable

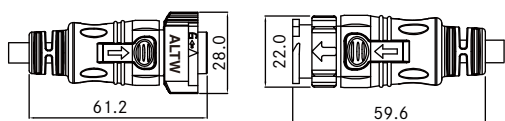

Field Installable

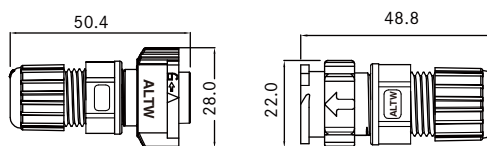

Cable OD Range : 4.0mm ~ 9.6mm
 Dimensions are shown in millimeters

Contact Configuration

	Middle Size	
	20A	
4 5	MM or FF	MF or FM
3 Pin		
	R C F	R C F

R: Receptacle
C: Overmolded with Cable
F: Field Installable

20A (SCC) 1

Number of Contacts: 2
 Ex.3 contacts (03)

Connector (Housing) Gender: 4
 Male (M) or Female (F)

Contact Gender: 5
 Male (S) or Female (P)

More to Choose: 6
 • Solder (S)

* More available: The Plating to Tin or Gold.

* Design and specification are subject to change without notice.

Find Our Standard Products

↘ Receptacle and Mating Pair

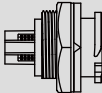
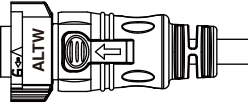
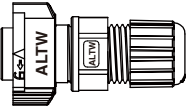
<ul style="list-style-type: none"> • Male Connector • Push Lock (Sprind loaded nut) 		<p>Receptacle</p> 	<p>Overmolded with Cable</p> 	<p>Field Installable</p> 
		** Selecting the cable length:01-99		
Current Rating (Code)	Contacts	Male Connector (M)	Female Connector (F)	Female Connector (F)
20A (SCC)	03	SCC- 03RMPS-QC7001	SCC- 03MFSS-QL70**	SCC- 03FFSC-QC7001

↘ In-line

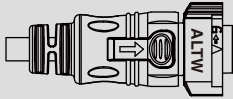
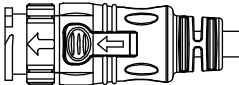
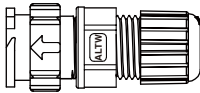
<ul style="list-style-type: none"> • Female Connector • Push Lock (Sprind loaded nut) 		<p>Overmolded with Cable</p> 	<p>Overmolded with Cable</p> 	<p>Field Installable</p> 
		** Selecting the cable length:01-99		
Current Rating (Code)	Contacts	Female Connector (F)	Male Connector (M)	Male Connector (M)
20A (SCC)	03	SCC- 03MFSS-QL70**	SCC- 03MMPS-QL70**	SCC- 03FMPC-QC7001

↘ In-line

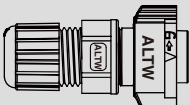
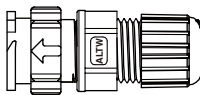
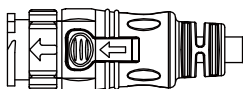
<ul style="list-style-type: none"> • Female Connector • Push Lock (Sprind loaded nut) 		<p>Field Installable</p> 	<p>Field Installable</p> 	<p>Overmolded with Cable</p> 
		** Selecting the cable length:01-99		
Current Rating (Code)	Contacts	Female Connector (F)	Male Connector (M)	Male Connector (M)
20A (SCC)	03	SCC- 03FFSC-QL7001	SCC- 03FMPC-QC7001	SCC- 03MMPS-QL70**

Accessories Index

- **Cable**
 - T-Cable21-1
 - Y-Cable21-3

- **Adaptor**
 - T-Adaptor21-4
 - Y-Adaptor21-6
 - I-Adaptor21-7

- **Cap**
 - Dust Cap21-9
 - Waterproof Cap21-11
 - Dummy21-18

- **Multi-port**
 - Multi-port21-19

- **Box**
 - Box21-21

- **Tool**
 - Wrench21-22
 - Unlock Tool21-22

- **Joint**
 - Joint21-23

- **Patch Cable (Double-ended)**
 - Patch Cable (Double-ended).....21-24

Accessories - Cable

➤ T-Cable > Circular > Standard Size: 5/8"-27 UNS

■ Customized – Upon Request

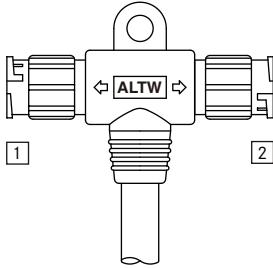

5 For connector 1
6 For connector 2

Choose Connector / Contacts Gender:
M: Male + Male
F: Female + Female
H: Male + Female
B: Female + Male

* Choose the cable length:01-99 m /
PVC UL2464 Cable

Current Rating	Contacts 2	Mating Style	Connector 1 (Male Connector / Male Contacts)	Connector 1 (Female Connector / Female Contacts)	More options
			Connector 2 (Male Connector / Male Contacts)	Connector 2 (Female Connector / Female Contacts)	
10A	02,03,04	Screw Thread	BA-2 2 00-MM0-TSA*	BA-2 2 00-FF0-TSA*	BA-2 2 00-5 6 0-TSA*
		2 point lock bayonet	BA-2 2 00-MM0-TLA*	BA-2 2 00-FF0-TLA*	BA-2 2 00-5 6 0-TLA*
5A	02,03,04,05,06,07,08	Screw Thread	BA-2 2 00-MM0-TSA*	BA-2 2 00-FF0-TSA*	BA-2 2 00-5 6 0-TSA*
		2 point lock bayonet	BA-2 2 00-MM0-TLA*	BA-2 2 00-FF0-TLA*	BA-2 2 00-5 6 0-TLA*
2A	10,12	Screw Thread	BA-2 2 00-MM0-TSA*	BA-2 2 00-FF0-TSA*	BA-2 2 00-5 6 0-TSA*
		2 point lock bayonet	BA-2 2 00-MM0-TLA*	BA-2 2 00-FF0-TLA*	BA-2 2 00-5 6 0-TLA*

➤ T-Cable > Circular > Other Size > Mix Size (10A+5A)

■ Customized – Upon Request

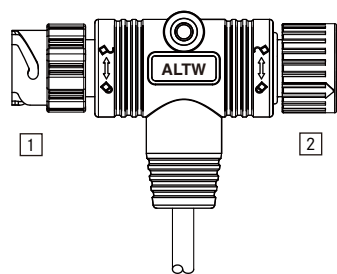

* Choose the cable length:01-99 m /
PVC UL2464 Cable

Current Rating	Contacts	Mating Style	Connector 1 (Male Connector / Male Contacts)	Connector 1 (Female Connector / Female Contacts)	Connector 1 (Male Connector / Male Contacts)
			Connector 2 (Male Connector / Male Contacts)	Connector 2 (Female Connector / Female Contacts)	Connector 2 (Female Connector / Female Contacts)
5A	08	Screw Thread	GA-080800-MM0-TSA*	GA-080800-FF0-TSA*	GA-080800-MF0-TSA*

└─ T-Cable > M Series Sensor > M12

■ Customized - Upon Request

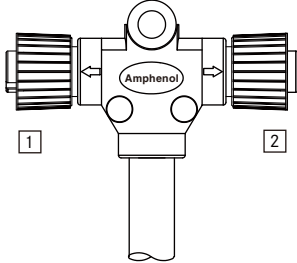

Choose Connector / Contacts Gender:

- 6 For connector 1
- 7 For connector 2

A/B/D Code
M: Male + Male
F: Female + Female
I Style
K: Connector (Male) + Contact (Male+Female)
Z: Connector (Female) + Contact (Male+Female)

* Choose the cable length: 0.1-99 m / PVC UL2464 Cable

Type	Current Rating	Contacts 2	Mating Style	Connector 1 (Male Connector / Male Contacts)	Connector 1 (Female Connector / Female Contacts)	More options	
				Connector 2 (Male Connector / Male Contacts)	Connector 2 (Female Connector / Female Contacts)		
M12	A Code	4A	03,04,05	Screw Thread	SS-2200-MM0-TSA*	SS-2200-FF0-TSA*	SS-2200-670-TSA*
		2A	08		SS-080800-MM0-TSA*	SS-080800-FF0-TSA*	SS-080800-670-TSA*
	B Code	4A	04,05		SB-2200-MM0-TSA*	SB-2200-FF0-TSA*	SB-2200-670-TSA*
	D Code	4A	04,05		SD-2200-MM0-TSA*	SD-2200-FF0-TSA*	SD-2200-670-TSA*
	I Style	4A	05		SI-050500-KK0-TSA*	SI-050500-ZZ0-TSA*	SI-050500-670-TSA*
M12 (Plastic)	A Code	4A	03,04,05	Screw Thread	PS-2200-MM0-TSA*	PS-2200-FF0-TSA*	PS-2200-670-TSA*
		2A	08		PS-080800-MM0-TSA*	PS-080800-FF0-TSA*	PS-080800-670-TSA*
	B Code	4A	04,05		PB-2200-MM0-TSA*	PB-2200-FF0-TSA*	PB-2200-670-TSA*
	D Code	4A	04,05		PD-2200-MM0-TSA*	PD-2200-FF0-TSA*	PD-2200-670-TSA*
	I Style	4A	05		PI-050500-KK0-TSA*	PI-050500-ZZ0-TSA*	PI-050500-670-TSA*

* Design and specification are subject to change without notice.

Y-Cable > M Series Sensor > M12

Customized - Upon Request

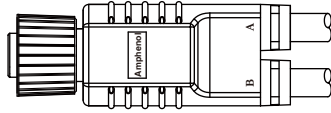

* Choose the cable length:01-99 m / PU VW-1Cable

Type		Current Rating	Contacts ②	Mating Style	Connector (Male Connector / Male Contacts)	Connector (Female Connector / Female Contacts)
M12	A Code	4A	03,04,05	Screw Thread	SS- ② 0000-M00-YSB*	SS- ② 0000-F00-YSB*
		2A	08	Screw Thread	SS-080000-M00-YSB*	SS-080000-F00-YSB*
	B Code	4A	04,05	Screw Thread	SB- ② 0000-M00-YSB*	SB- ② 0000-F00-YSB*
	D Code	4A	04,05	Screw Thread	SD- ② 0000-M00-YSB*	SD- ② 0000-F00-YSB*
	I Style	4A	05	Screw Thread	SI-050000-K00-YSB*	SI-050000-Z00-YSB*

Accessories - Adaptor

└ T-Adaptor > Circular > Mini Size: 7/16"-28 UNS

■ Customized - Upon Request

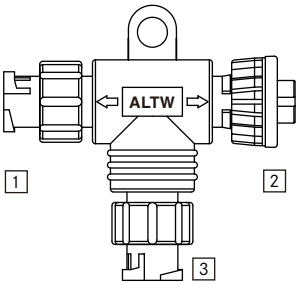

5 For connector 1
6 For connector 2
7 For connector 3

Choose Connector / Contacts Gender:
M: Male + Male
F: Female + Female

Current Rating	Contacts 2	Mating Style	Connector 1 (Male Connector / Male Contacts)	Connector 1 (Female Connector / Female Contacts)	More options
			Connector 2 (Male Connector / Male Contacts)	Connector 2 (Female Connector / Female Contacts)	
			Connector 3 (Male Connector / Male Contacts)	Connector 3 (Female Connector / Female Contacts)	
5A	02,03	Screw Thread	AA- 2 2 2 -MMM-TS001	AA- 2 2 2 -FFF-TS001	AA- 2 2 2 - 5 6 7 -TS001
		2 point lock bayonet	AA- 2 2 2 -MMM-TL001	AA- 2 2 2 -FFF-TL001	AA- 2 2 2 - 5 6 7 -TL001
2A	04,05,06	Screw Thread	AA- 2 2 2 -MMM-TS001	AA- 2 2 2 -FFF-TS001	AA- 2 2 2 - 5 6 7 -TS001
		2 point lock bayonet	AA- 2 2 2 -MMM-TL001	AA- 2 2 2 -FFF-TL001	AA- 2 2 2 - 5 6 7 -TL001

└ T-Adaptor > Circular > Standard Size: 5/8"-27 UNS

■ Customized - Upon Request

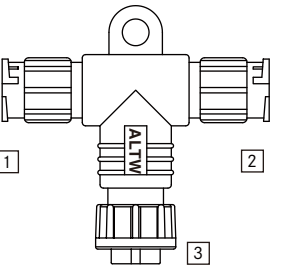

5 For connector 1
6 For connector 2
7 For connector 3

Choose Connector / Contacts Gender:
M: Male + Male
F: Female + Female
H: Male + Female
B: Female + Male

* Choose the cable length:01-99 m /
PVC UL2464 Cable

Current Rating	Contacts 2	Mating Style	Connector 1 (Male Connector / Male Contacts)	Connector 1 (Female Connector / Female Contacts)	More options
			Connector 2 (Male Connector / Male Contacts)	Connector 2 (Female Connector / Female Contacts)	
			Connector 3 (Male Connector / Male Contacts)	Connector 3 (Female Connector / Female Contacts)	
5A	02,03,04, 05,06,07, 08	Screw Thread	BA- 2 2 2 -MMM-TS001	BA- 2 2 2 -FFF-TS001	BA- 2 2 2 - 5 6 7 -TS001
		2 point lock bayonet	BA- 2 2 2 -MMM-TL001	BA- 2 2 2 -FFF-TL001	BA- 2 2 2 - 5 6 7 -TL001
2A	10, 12	Screw Thread	BA- 2 2 2 -MMM-TS001	BA- 2 2 2 -FFF-TS001	BA- 2 2 2 - 5 6 7 -TS001
		2 point lock bayonet	BA- 2 2 2 -MMM-TL001	BA- 2 2 2 -FFF-TL001	BA- 2 2 2 - 5 6 7 -TL001

* Design and specification are subject to change without notice.

↳ T-Adaptor > M Series Sensor > M12

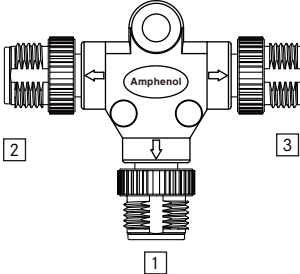
<div style="display: flex; align-items: center;"> <div style="width: 15px; height: 15px; background-color: #ccc; margin-right: 5px;"></div> Customized - Upon Request </div>								Choose Connector / Contacts Gender: 5 For connector 1 6 For connector 2 7 For connector 3 <u>A/B/D Code</u> M: Male + Male F: Female + Female <u>I Style</u> K: Connector (Male) + Contact (Male+Female) Z: Connector (Female) + Contact (Male+Female)		
Type	Current Rating	Contacts 2	Mating Style	Connector 1 (Male Connector / Male Contacts)	Connector 1 (Female Connector / Female Contacts)	More options				
				Connector 2 (Male Connector / Male Contacts)	Connector 2 (Female Connector / Female Contacts)					
				Connector 3 (Male Connector / Male Contacts)	Connector 3 (Female Connector / Female Contacts)					
M 12	A Code	4A	03,04,05	Screw Thread	SS- 2 2 2 -MMM-TS001	SS- 2 2 2 -FFF-TS001	SS- 2 2 2 -5 6 7 -TS001			
		2A	08	Screw Thread	SS-080808-MMM-TS001	SS-080808-FFF-TS001	SS-080808-5 6 7 -TS001			
	B Code	4A	04,05	Screw Thread	SB- 2 2 2 -MMM-TS001	SB- 2 2 2 -FFF-TS001	SB- 2 2 2 -5 6 7 -TS001			
	D Code	4A	04,05	Screw Thread	SD- 2 2 2 -MMM-TS001	SD- 2 2 2 -FFF-TS001	SD- 2 2 2 -5 6 7 -TS001			
	I Style	4A	05	Screw Thread	SI-050505-KKK-TS001	SI-050505-ZZZ-TS001	SI-050505-5 6 7 -TS001			
M 12 (Plastic)	A Code	4A	03,04,05	Screw Thread	PS- 2 2 2 -MMM-TS001	PS- 2 2 2 -FFF-TS001	PS- 2 2 2 -5 6 7 -TS001			
		2A	08	Screw Thread	PS-080808-MMM-TS001	PS-080808-FFF-TS001	PS-080808-5 6 7 -TS001			
	B Code	4A	04,05	Screw Thread	PB- 2 2 2 -MMM-TS001	PB- 2 2 2 -FFF-TS001	PB- 2 2 2 -5 6 7 -TS001			
	D Code	4A	04,05	Screw Thread	PD- 2 2 2 -MMM-TS001	PD- 2 2 2 -FFF-TS001	PD- 2 2 2 -5 6 7 -TS001			
	I Style	4A	05	Screw Thread	PI-050505-KKK-TS001	PI-050505-ZZZ-TS001	PI-050505-5 6 7 -TS001			

Y-Adaptor > M Series Sensor > M12

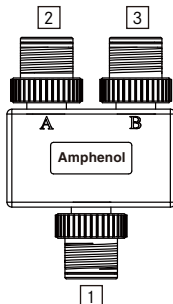
		Customized – Upon Request				Choose Connector / Contacts Gender:	
Type	Current Rating	Contacts 2	Mating Style	Connector 1 (Male Connector / Male Contacts)	Connector 1 (Female Connector / Female Contacts)	More options	
				Connector 2 (Male Connector / Male Contacts)	Connector 2 (Female Connector / Female Contacts)		
				Connector 3 (Male Connector / Male Contacts)	Connector 3 (Female Connector / Female Contacts)		
M 12	A Code	4A	03,04,05	Screw Thread	SS-222-MMM-YS001	SS-222-FFF-YS001	SS-222-567-YS001
		2A	08	Screw Thread	SS-080808-MMM-YS001	SS-080808-FFF-YS001	SS-080808-567-YS001
	B Code	4A	04,05	Screw Thread	SB-222-MMM-YS001	SB-222-FFF-YS001	SB-222-567-YS001
	D Code	4A	04,05	Screw Thread	SD-222-MMM-YS001	SD-222-FFF-YS001	SD-222-567-YS001
	I Style	4A	05	Screw Thread	SI-050505-KKK-YS001	SI-050505-ZZZ-YS001	SI-050505-567-YS001
M 12 (Plastic)	A Code	4A	03,04,05	Screw Thread	PS-222-MMM-YS001	PS-222-FFF-YS001	PS-222-567-YS001
		2A	08	Screw Thread	PS-080808-MMM-YS001	PS-080808-FFF-YS001	PS-080808-567-YS001
	B Code	4A	04,05	Screw Thread	PB-222-MMM-YS001	PB-222-FFF-YS001	PB-222-567-YS001
	D Code	4A	04,05	Screw Thread	PD-222-MMM-YS001	PD-222-FFF-YS001	PD-222-567-YS001
	I Style	4A	05	Screw Thread	PI-050505-KKK-YS001	PI-050505-ZZZ-YS001	PI-050505-567-YS001

* Design and specification are subject to change without notice.

∨ I-Adaptor > Circular > Mini Size: 7/16"-28 UNS

■ Customized – Upon Request

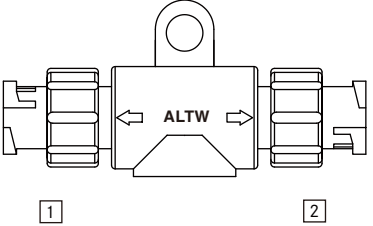

6 For connector 1
7 For connector 2

Choose Connector / Contacts Gender:
M: Male + Male
F: Female + Female

Current Rating	Contacts 3	Mating Style	Connector 1 (Male Connector / Male Contacts)	Connector 1 (Female Connector / Female Contacts)	More options
			Connector 2 (Male Connector / Male Contacts)	Connector 2 (Female Connector / Female Contacts)	
5A	02,03	Screw Thread	AA-00 3 3 -0MM-IS001	AA-00 3 3 -0FF-IS001	AA-00 3 3 -0 6 7 -IS001
		2 point lock bayonet	AA-00 3 3 -0MM-IL001	AA-00 3 3 -0FF-IL001	AA-00 3 3 -0 6 7 -IL001
2A	04,05,06	Screw Thread	AA-00 3 3 -0MM-IS001	AA-00 3 3 -0FF-IS001	AA-00 3 3 -0 6 7 -IS001
		2 point lock bayonet	AA-00 3 3 -0MM-IL001	AA-00 3 3 -0FF-IL001	AA-00 3 3 -0 6 7 -IL001

∨ I-Adaptor > Circular > Standard Size: 5/8"-27 UNS

■ Customized – Upon Request

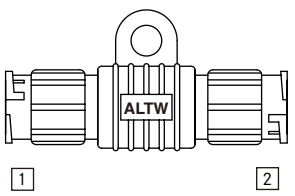

6 For connector 1
7 For connector 2

Choose Connector / Contacts Gender:
M: Male + Male
F: Female + Female
H: Male + Female
B: Female + Male

Current Rating	Contacts 3	Mating Style	Connector 1 (Male Connector / Male Contacts)	Connector 1 (Female Connector / Female Contacts)	More options
			Connector 2 (Male Connector / Male Contacts)	Connector 2 (Female Connector / Female Contacts)	
5A	02,03,04,05,06,07,08	Screw Thread	BA-00 3 3 -0MM-IS001	BA-00 3 3 -0FF-IS001	BA-00 3 3 -0 6 7 -IS001
		2 point lock bayonet	BA-00 3 3 -0MM-IL001	BA-00 3 3 -0FF-IL001	BA-00 3 3 -0 6 7 -IL001
2A	10,12	Screw Thread	BA-00 3 3 -0MM-IS001	BA-00 3 3 -0FF-IS001	BA-00 3 3 -0 6 7 -IS001
		2 point lock bayonet	BA-00 3 3 -0MM-IL001	BA-00 3 3 -0FF-IL001	BA-00 3 3 -0 6 7 -IL001

└ I-Adaptor > Circular > Other Size > Mix Size (10A+5A)

■ Customized - Upon Request

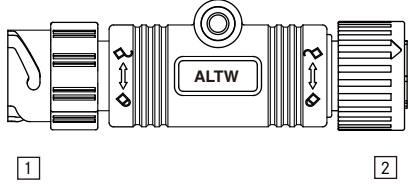

Current Rating	Contacts	Mating Style	Connector 1 (Male Connector / Male Contacts)	Connector 1 (Female Connector / Female Contacts)	Connector 1 (Female Connector / Female Contacts)
			Connector 2 (Male Connector / Male Contacts)	Connector 2 (Female Connector / Female Contacts)	Connector 1 (Male Connector / Male Contacts)
5A	08	3 point lock bayonet	GA-000808-0MM-IT001	GA-000808-OFF-IT001	GA-000808-0FM-IT001

└ I-Adaptor > M Series Sensor > M12

■ Customized - Upon Request

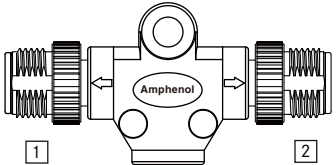

Choose Connector / Contacts Gender:

- 6 For connector 1
- 7 For connector 2

A/B/D Code
M: Male + Male
F: Female + Female
I Style
K: Connector (Male) + Contact (Male+Female)
Z: Connector (Female) + Contact (Male+Female)

Type	Current Rating	Contacts 3	Mating Style	Connector 1 (Male Connector / Male Contacts)	Connector 1 (Female Connector / Female Contacts)	More options	
				Connector 2 (Male Connector / Male Contacts)	Connector 2 (Female Connector / Female Contacts)		
M12	A Code	4A	03,04,05	Screw Thread	SS-00 3 3 -0MM-IS001	SS-00 3 3 -OFF-IS001	SS-00 3 3 -0 6 7 -IS001
		2A	08	Screw Thread	SS-000808-0MM-IS001	SS-000808-OFF-IS001	SS-000808-0 6 7 -IS001
	B Code	4A	04,05	Screw Thread	SB-00 3 3 -0MM-IS001	SB-00 3 3 -OFF-IS001	SB-00 3 3 -0 6 7 -IS001
		4A	04,05	Screw Thread	SD-00 3 3 -0MM-IS001	SD-00 3 3 -OFF-IS001	SD-00 3 3 -0 6 7 -IS001
	I Style	4A	05	Screw Thread	SI-000505-0KK-IS001	SI-000505-0ZZ-IS001	SI-000505-0KZ-IS001 SI-000505-0ZK-IS001
M12 (Plastic)	A Code	4A	03,04,05	Screw Thread	PS-00 3 3 -0MM-IS001	PS-00 3 3 -OFF-IS001	PS-00 3 3 -0 6 7 -IS001
		2A	08	Screw Thread	PS-000808-0MM-IS001	PS-000808-OFF-IS001	PS-000808-0 6 7 -IS001
	B Code	4A	04,05	Screw Thread	PB-00 3 3 -0MM-IS001	PB-00 3 3 -OFF-IS001	PB-00 3 3 -0 6 7 -IS001
		4A	04,05	Screw Thread	PD-00 3 3 -0MM-IS001	PD-00 3 3 -OFF-IS001	PD-00 3 3 -0 6 7 -IS001
	I Style	4A	05	Screw Thread	PI-000505-0KK-IS001	PI-000505-0ZZ-IS001	PI-000505-0KZ-IS001 PI-000505-0ZK-IS001

* Design and specification are subject to change without notice.

Accessories - Cap

∟ Dust Cap >Circular

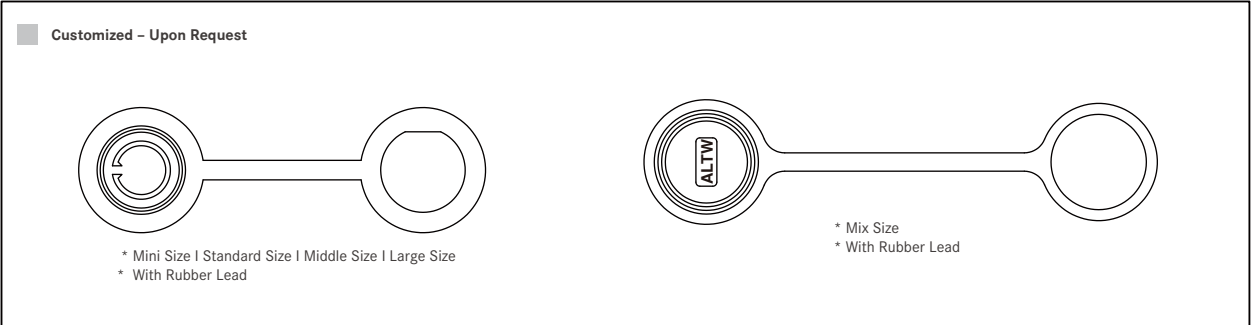

Size	Mating Pair	Mating Pair (Gender)	P/N
Mini Size 7/16"-28 UNS	Receptacle	Male	CAP-DAAMDPC 1
Standard Size 5/8"-27 UNS	Receptacle	Male	CAP-DABMDPC 1 CAP-DABMDPC 2 CAP-DABMDPC 3
		Female	-
	Overmolded with Cable	Male	CAP-DABMDCC 1 CAP-DABMDCC 2
		Female	CAP-DABFDCC 1
Middle Size 13/16"-28 UNS	Receptacle	Male	CAP-DACMDPC 1 CAP-DACMDPC 2
	Overmolded with Cable	Female	CAP-DACFDCC 1
Large Size 1"-20 UNEF	Receptacle	Male	CAP-DADMDPC 1
Mix Size 12-5A	Receptacle	Male	CAP-DPLMDPC 1

▾ Dust Cap > D-SUB > Standard & High Density

■ Customized - Upon Request

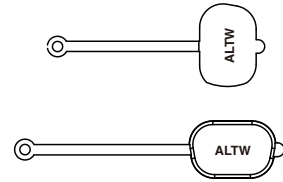
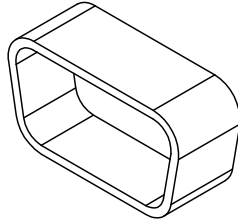

*Choose rubber lead: Vertical type (1) / Horizontal type (2)

Type		Mating Pairs	Mating Pair (Gender)	P/N
Standard D-SUB	High Density D-SUB			
Standard (9 pins)	High Density (15 Pins)	Receptacle (With horizontal rubber lead)	Male	CAP-DD1MDPC2
		Receptacle and Overmolded with Cable (With horizontal / Vertical rubber lead)		CAP-DD1MDMA1
		Receptacle	Female	CAP-DD1FDPC1* CAP-DD1FDPC2*
		Receptacle and Overmolded with Cable		CAP-DD1FDMA1
Standard (15 pins)	High Density (26 Pins)	Receptacle and Overmolded with Cable	Male	CAP-DD2MDMA1
		Receptacle and Overmolded with Cable	Female	CAP-DD2FDMA1
Standard (25 pins)	High Density (44 Pins)	Receptacle and Overmolded with Cable	Male	CAP-DD3MDMA1
		Receptacle (With horizontal rubber lead)	Female	CAP-DD3FDPC1
		Receptacle and Overmolded with Cable		CAP-DD3FDMA1

* Design and specification are subject to change without notice.

Waterproof Cap >Circular

Customized - Upon Request

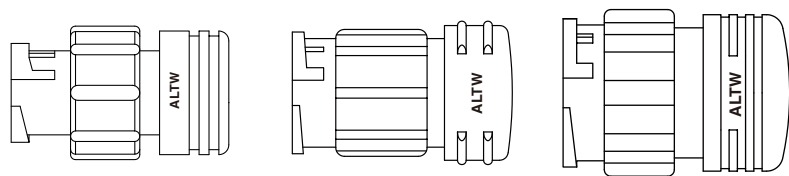

* Mini Size * Standard Size * Middle Size

Choose Connector / Contacts Gender:
 6 More to choose: None(A) / With Chain(B) / With Rubber Lead(C) / With Fish Line(D)
 7 Choose 2 contacts(1) / 3 contacts(3) / 4~6 contacts(2) for male mating pair

Size	Mating Pair	Mating Style	Mating Pair (Gender)	P/N	
Mini Size 7/16"-28 UNS	Receptacle	Screw Thread	Male	CAP-WAAMSP 6 1	
		2 point lock bayonet	Male	CAP-WAAML P 6 7	
			Female	CAP-WAFL P 6 7	
	Overmolded with Cable	Screw Thread	Male	CAP-WAAMSMA 1	
		2 point lock bayonet	Male	CAP-WAAMLMA 7	
			Female	CAP-WAFLMA 7	
		Receptacle and Overmolded with Cable	Screw Thread	Male	CAP-WAAMSMA 1
	2 point lock bayonet		Male	CAP-WAAMLMA 7	
			Female	CAP-WAFLMA 7	
	Standard Size 5/8"-27 UNS	Receptacle	Screw Thread	Male	CAP-WABMSP 6 1
			2 point lock bayonet	Female	CAP-WABFSP 6 1
				Male	CAP-WABML P 6 7
Female			CAP-WABFL P 6 7		
Overmolded with Cable		Screw Thread	Male	CAP-WABMSMA 1	
		2 point lock bayonet	Female	CAP-WABFSMA 1	
			Male	CAP-WABMLMA 7	
		Female	CAP-WABFLMA 7		
Receptacle and Overmolded with Cable		Screw Thread	Male	CAP-WABMSMA 1	
		2 point lock bayonet	Female	CAP-WABFSMA 1	
			Male	CAP-WABMLMA 7	
		Female	CAP-WABFLMA 7		
Middle Size 13/16"-28 UNS	Receptacle	Screw Thread	Male	CAP-WACMSP 6 7	
		2 point lock bayonet	Male	CAP-WACML P 6 1	
			Female	CAP-WACFL P 6 1	
	Overmolded with Cable	Screw Thread	Male	CAP-WACMSMA 7	
		2 point lock bayonet	Male	CAP-WACMLMA 1	
			Female	CAP-WACFLMA 1	
		Receptacle and Overmolded with Cable	Screw Thread	Male	CAP-WACMSMA 7
	2 point lock bayonet		Male	CAP-WACMLMA 1	
			Female	CAP-WACFLMA 1	

Waterproof Cap >Circular

■ Customized - Upon Request

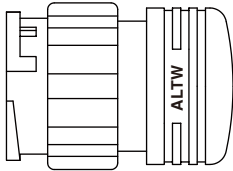

* Large Size

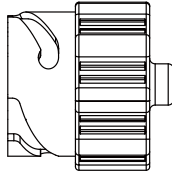

* Mix Size

⑥ More to choose: None(A) / With Chain(B) / With Rubber Lead(C) / With Fish Line(D)

⑦ Choose 18 contacts(2) for female mating pair

Size	Mating Pair	Mating Style	Mating Pair (Gender)	P/N
Large Size 1"-20 UNEF	Receptacle	Screw Thread	Male	CAP-WADMSP ⑥ 1
		2 point lock bayonet	Male	CAP-WADMLP ⑥ ⑦
	Overmolded with Cable	2 point lock bayonet	Female	CAP-WADFLP ⑥ ⑦
		Screw Thread	-	-
	Receptacle and Overmolded with Cable	Screw Thread	-	-
			2 point lock bayonet	-
		2 point lock bayonet	Male	CAP-WADMSMA1
			Female	CAP-WADFLMA ⑦
Mix Size (Between Standard & Middle Size)	Receptacle	3 Points Lock	Male	CAP-WADMLP ⑥ ⑦
			Female	CAP-WADFLP ⑥ ⑦
	Receptacle and Overmolded with Cable	3 Points Lock	Male	CAP-WEBMLP ⑥ 1
			Female	CAP-WEBFLP ⑥ 1
			Male	CAP-WEBMLMA1
			Female	CAP-WEBFLMA1

* Design and specification are subject to change without notice.

Waterproof Cap > Power

Customized – Upon Request

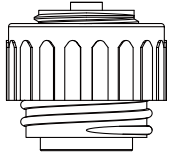

* 8A (PWE) | 12A (PWF) | 16A (PWG)

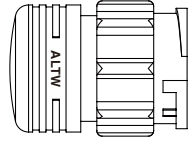

* 20A (PWC) | 20A+2A (PWCU)

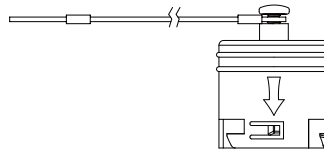

* 25A (PWH) | 30A (PWJ)

6 More to choose: None(A) / With Chain(B) / With Rubber Lead(C) / With Fish Line(D)

Current Rating	Mating Pair	Mating Style	Mating Pair (Gender)	P/N	
8A(PWE)	Receptacle	Screw Thread	Male	CAP-WTAMSP 6 1	
			Female	CAP-WTAFSP 6 1	
	Receptacle and Overmolded with Cable		Male	CAP-WTAMSMA1	
	Receptacle and Overmolded with Cable		Female	CAP-WTAFSMA1	
12A(PWF)	Receptacle	Screw Thread	Male	CAP-WTAMSP 6 1	
			Female	CAP-WTAFSP 6 1	
	Receptacle and Overmolded with Cable		Male	CAP-WTAMSMA1	
	Receptacle and Overmolded with Cable		Female	CAP-WTAFSMA1	
16A(PWG)	Receptacle	Screw Thread	Male	CAP-WTAMSP 6 1	
			Female	CAP-WTAFSP 6 1	
	Receptacle and Overmolded with Cable		Male	CAP-WTAMSMA1	
	Receptacle and Overmolded with Cable		Female	CAP-WTAFSMA1	
20A(PWC)	Receptacle	2 point lock bayonet	Male	CAP-WACMLP 6 1	
	Receptacle and Overmolded with Cable			CAP-WACMLMA1	
	Receptacle and Overmolded with Cable		Female	CAP-WACFLMA2	
20A+2A(PWCU)	Receptacle	2 point lock bayonet	Male	CAP-WACMLP 6 1	
	Receptacle and Overmolded with Cable			CAP-WACMLMA1	
	Receptacle and Overmolded with Cable		Female	CAP-WACFLMA2	
25A(PWH)	Receptacle and Overmolded with Cable	3 point lock bayonet	Female	CAP-WPWFTMD1	
30A(PWJ)	Receptacle and Overmolded with Cable	3 point lock bayonet	Male	CAP-WPWMTMD1	

Waterproof Cap > Sensor > M8

Customized - Upon Request

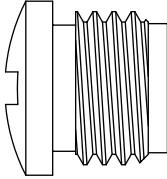

For Female

Size	Mating Pair	Mating Style	Mating Pair (Gender)	P/N
M8	Overmolded with Cable	Screw Thread	Female	CAP-WBBFSCC1
	Receptacle and Overmolded with Cable	Screw Thread	Male	CAP-WBBMSMA1
			Female	CAP-WBBFSMA1

Waterproof Cap > Sensor > M10.5

Customized - Upon Request

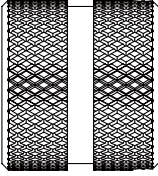

For male

Size	Mating Pair	Mating Style	Mating Pair (Gender)	P/N
M 10.5	Receptacle and Overmolded with Cable	Screw Thread	Male	CAP-WBCMSMA2

* Design and specification are subject to change without notice.

Waterproof Cap > Sensor > M12

Customized – Upon Request

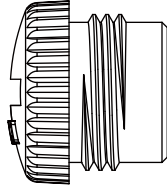

7 Choose plastic(1) or metal(2) items

Size	Size	Mating Pair	Mating Style	Mating Pair (Gender)	P/N
M12	A/B/D Code I Style	Receptacle	Screw Thread	Male	CAP-WBDPMSB1
		Receptacle and Overmolded with Cable	Screw Thread	Male	CAP-WBDMSMA 7
Female	CAP-WBDFSMA 7				
M12(Plastic)	A/B/D Code I Style	Receptacle and Overmolded with Cable	Screw Thread	Male	CAP-WBDMSMA1 7
				Female	CAP-WBDFSMA1 7

Waterproof Cap > Sensor > Heavy Duty Shielded Connectors

Customized – Upon Request

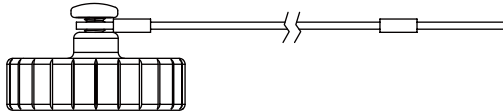

Size	Mating Pair	Mating Style	Mating Pair (Gender)	P/N
M22	Receptacle	Screw Thread	Male	CAP-WHBMSPD1

Waterproof Cap > Sensor > M23

Customized – Upon Request

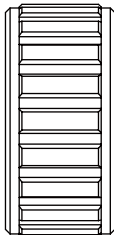

Size	Mating Pair	Mating Style	Mating Pair (Gender)	P/N
M23	Receptacle and Overmolded with Cable	Screw Thread	Male	CAP-WBHMSMA1

Waterproof Cap > USB | IEEE 1394

■ Customized - Upon Request

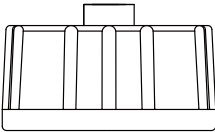

* USB Screw (Mating Pair: Male)

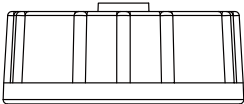

* USB Lock



* USB Screw (Mating Pair: Female)

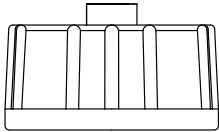

* IEEE 1394

⑥ More to choose: None(A) / With Chain(B) / With Rubber Lead(C) / With Fish Line(D)

Type	Mating Pair	Mating Style	Mating Pair (Gender)	P/N
USB 2.0 Type A USB 2.0 Type B USB 3.0 Type A	Receptacle	Screw Thread	Male	CAP-WACMSP ⑥ 1
		2 point lock bayonet	Male	CAP-WADMLP ⑥ 1
	Receptacle and Overmolded with Cable	Screw Thread	Male	CAP-WACMSMA1
		2 point lock bayonet	Male	CAP-WADMLMA1
	Overmolded with Cable	Screw Thread	Female	CAP-WUSFSCC1
IEEE 1394	Receptacle	Screw Thread	Male	CAP-WACMSP ⑥ 1
	Receptacle and Overmolded with Cable	Screw Thread	Male	CAP-WACMSMA1

Waterproof Cap > D-SUB | DVI

■ Customized - Upon Request

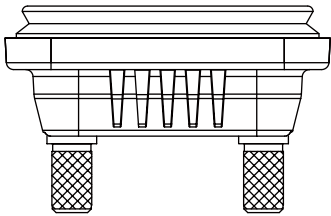

⑦ Choose rubber lead: Vertical type (1) / Horizontal type (2)

Type		Mating Pairs	Mating Style	Mating Pair (Gender)	P/N
Standard D-SUB	High Density D-SUB				
Standard (9 pins)	High Density (15 Pins)	Receptacle	Screw Thread	Male & Female	CAP-WD1CSPA1
Standard (15 pins)	High Density (26 Pins)	Receptacle	Screw Thread	Male & Female	CAP-WD2CSPA1
Standard (25 pins)	High Density (44 Pins)	Receptacle	Screw Thread	Male & Female	CAP-WD3CSPA1
DVI		Receptacle	Screw Thread	Male & Female	CAP-WDVCSPA1

* Design and specification are subject to change without notice.

Waterproof Cap > RJ

■ Customized - Upon Request

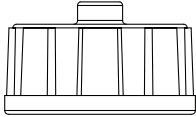

* RJ C 3 Point Lock

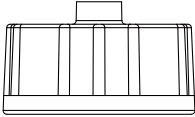

* RJ C Screw

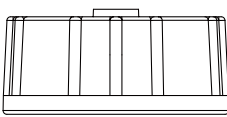

* RJ D Screw

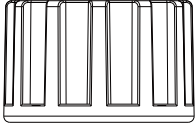

* RJ ODVA 3 Point Lock

6 More to choose: None(A) / With Chain(B)
/ With Rubber Lead(C) / With Fish Line(D)

7 Choose plastic (1) or metal (2) items

Size	Mating Pair	Mating Style	Mating Pair (Gender)	P/N
C Size	Receptacle	3 point lock bayonet	Male	CAP-WACMTMA1 CAP-WACMTP 6 1
		Screw Thread	Male	CAP-WACMSMA 7 CAP-WACMSP 6 7
D Size	Receptacle	Screw Thread	Male	CAP-WADMSMA1 CAP-WADMSP 6 1
ODVA	Receptacle	3 point lock bayonet	Male	CAP-WEOFTPC1

Waterproof Cap > HDMI

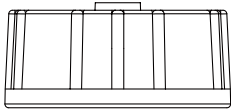

* D Size (Circular Type)

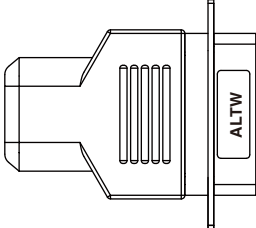

* Rectangle Type

Size	Mating Pair	Mating Style	Mating Pair (Gender)	P/N
D Size (Circular Type)	Receptacle	Screw Thread	Male	CAP-WADMSMA 1
Rectangle Type	Receptacle	Latch Type	Female	CAP-WHDFLPA1

Waterproof Cap > Fiber Optic

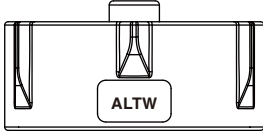
<input type="checkbox"/> Customized - Upon Request				
				
7 Choose rubber lead: Vertical type (1) / Horizontal type (2)				
Size	Mating Pair	Mating Style	Mating Pair (Gender)	P/N
Fiber Optic	Receptacle and Overmolded with Cable	3 point lock bayonet	Female	CAP-WFBFTMA1

Dummy > Circular > Middle Size: 13/16"-28 UNS

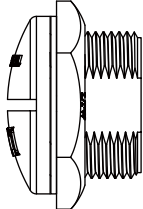
<input type="checkbox"/> Customized - Upon Request			
			
Size	Mating Pair	Mating Style	P/N
13/16"-28 UNS	Receptacle (Female)	Screw Thread	CAP-CACFSBA1

* Design and specification are subject to change without notice.

Accessories - Multi-port

Multi-port > Circular > Mini Size: 7/16"-28 UNS

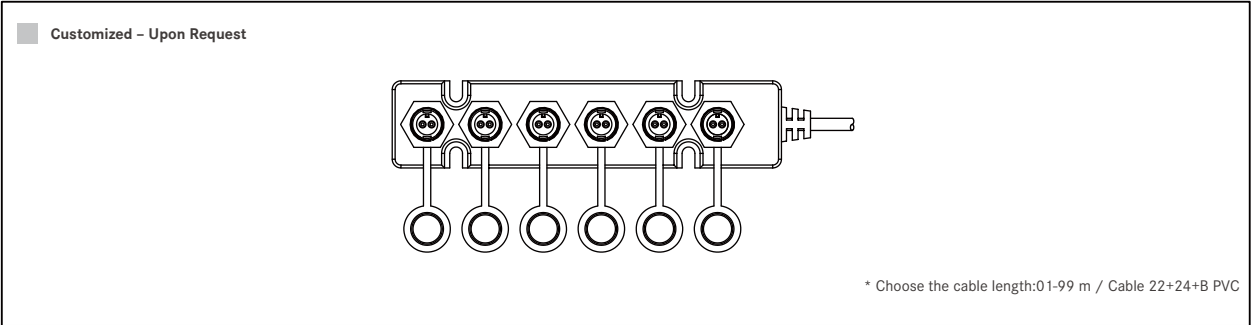

Current Rating	Contacts 2	Mating Style	Connector 1 (Male Connector / Male Contacts)	Connector 1 (Male Connector / Female Contacts)	More options
			Connector 2 (Male Connector / Male Contacts)	Connector 2 (Male Connector / Female Contacts)	
			Connector 3 (Male Connector / Male Contacts)	Connector 3 (Male Connector / Female Contacts)	
			Connector 4 (Male Connector / Male Contacts)	Connector 4 (Male Connector / Female Contacts)	
			Connector 5 (Male Connector / Male Contacts)	Connector 5 (Male Connector / Female Contacts)	
			Connector 6 (Male Connector / Male Contacts)	Connector 6 (Male Connector / Female Contacts)	
			5A	02,03	
2 point lock bayonet	A-2 2 2 2 2 2-MMMMMM-LA* A-22222-MMMMMM-LA01	A-2 2 2 2 2 2-HHHHHH-LA*			A-2 2 2 2 2-7 8 9 10 11 12 13-LA*
2A	04,05,06	Screw Thread	A-2 2 2 2 2 2-MMMMMM-SA*	A-2 2 2 2 2 2-HHHHHH-SA*	A-2 2 2 2 2-7 8 9 10 11 12 13-SA*
		2 point lock bayonet	A-2 2 2 2 2 2-MMMMMM-LA*	A-2 2 2 2 2 2-HHHHHH-LA*	A-2 2 2 2 2-7 8 9 10 11 12 13-LA*

Multi-port > Circular > Standard Size: 5/8"-27 UNS

Customized - Upon Request

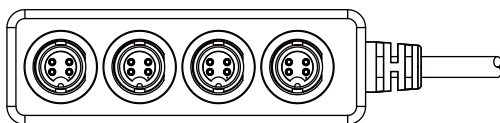

- 6 For connector 1
- 7 For connector 2
- 8 For connector 3
- 9 For connector 4

Choose Connector / Contacts Gender:

- M: Male + Male
- F: Female + Female

* Choose the cable length:01-99 m / Cable 22+24+B PVC

Current Rating	Contacts 2	Mating Style	Connector 1 (Male Connector / Male Contacts)	Connector 1 (Male Connector / Female Contacts)	More options
			Connector 2 (Male Connector / Male Contacts)	Connector 2 (Male Connector / Female Contacts)	
			Connector 3 (Male Connector / Male Contacts)	Connector 3 (Male Connector / Female Contacts)	
			Connector 4 (Male Connector / Male Contacts)	Connector 4 (Male Connector / Female Contacts)	
10A	02,03,04	Screw Thread	B-2 2 2 2 -MMMMMM-SA*	B-2 2 2 2 -HHHHHH-SA*	B-2 2 2 2 -6 7 8 9 -SA*
		2 point lock bayonet	B-2 2 2 2 -MMMMMM-LA*	B-2 2 2 2 -HHHHHH-LA*	B-2 2 2 2 -6 7 8 9 -LA*
5A	02,03,04,05,06,07,08	Screw Thread	B-2 2 2 2 -MMMMMM-SA*	B-2 2 2 2 -HHHHHH-SA* B-04040404-HHHH-SA*	B-2 2 2 2 -6 7 8 9 -SA*
		2 point lock bayonet	B-2 2 2 2 -MMMMMM-LA*	B-2 2 2 2 -HHHHHH-LA*	B-2 2 2 2 -6 7 8 9 -LA*
2A	10, 12	Screw Thread	B-2 2 2 2 -MMMMMM-SA*	B-2 2 2 2 -HHHHHH-SA*	B-2 2 2 2 -6 7 8 9 -SA*
		2 point lock bayonet	B-2 2 2 2 -MMMMMM-LA*	B-2 2 2 2 -HHHHHH-LA*	B-2 2 2 2 -6 7 8 9 -LA*

* Design and specification are subject to change without notice.

Accessories - Box

└ Box > USB > 2.0 Type A, 2.0 Type B

■ Customized - Upon Request

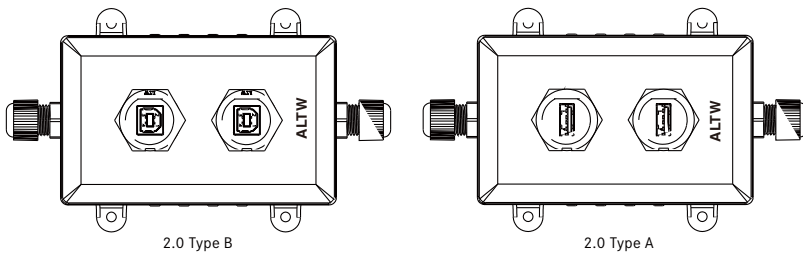

Type	Ports	P/N
2.0 Type A	1	BOX-USA11
	2	BOX-USA22
	4	BOX-USA44
2.0 Type B	1	BOX-USB11
	2	BOX-USB22
	4	BOX-USB44

Accessories - Tool

Wrench > Circular > Standard Size:
5/8"-27 UNS

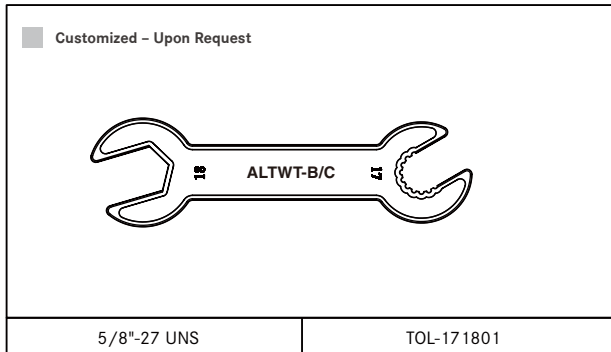

Wrench > Circular > Middle Size:
13/16"-28 UNS

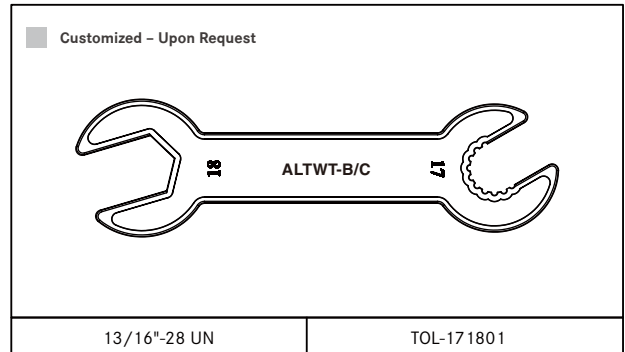

Wrench > Circular > Large Size:
1"-20 UNEF

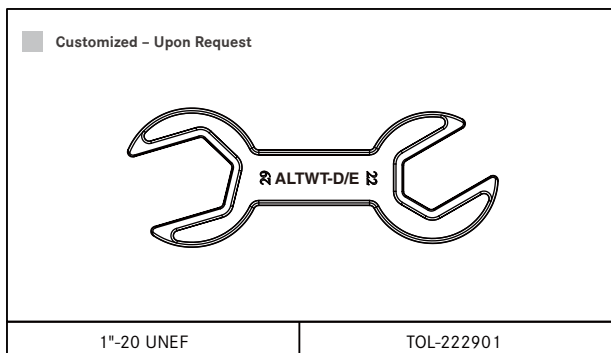

Unlock Tool > Cable Joiner >
8~10mm/10~12mm/12~16mm

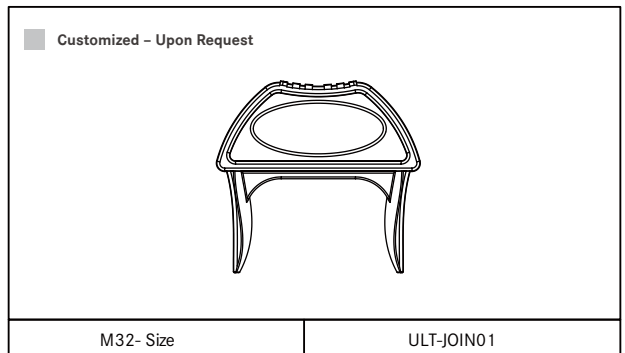

* Design and specification are subject to change without notice.

Accessories - Joint

∟ Joint > D-SUB > Standard & High Density

■ Customized - Upon Request

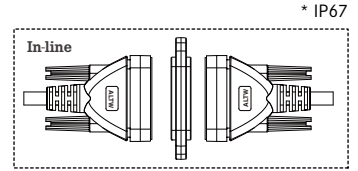
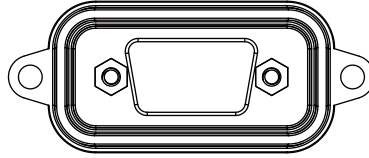

Type		Mating Style	P/N
Standard D-SUB	High Density D-SUB		
Standard (9 pins)	High Density (15 Pins)	Screw Thread	DJ1-00JNNA-SL7001
Standard (15 pins)	High Density (26 Pins)	Screw Thread	DJ2-00JNNA-SL7001
Standard (25 pins)	High Density (44 Pins)	Screw Thread	DJ3-00JNNA-SL7001

Accessories - Patch Cable (Double-ended)

▾ Patch Cable (Double-ended) > RJ

■ Customized - Upon Request

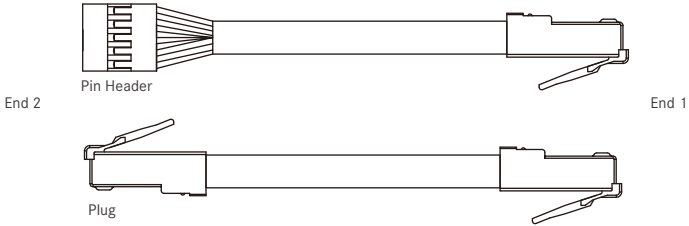

Gold Plated 6u"
Pitch 2.54mm
Select cable length 10cm/20cm/30cm

End 1		End 2		P / N
Type	Gender	Type	Gender	
RJ 45 Unshielded	Plug	RJ 45 Unshielded	Plug	UPG06-CHOP1-C10
			Pin Header	UPG06-UPG06-C10

* Design and specification are subject to change without notice.

Glossary

∟ **IP: IP65 • IP66 • IP67 • ALTW IP 68 (According to IEC 60950 standard.)**

The IP Rating- Ingress Protection Rating, sometimes also interpreted as International Protection Rating, classifies and rates the degree of protection provided against the intrusion of solid objects (including body parts like hands and fingers), dust, accidental contact, and water in mechanical casings and with electrical enclosures.

The standard aims to provide users more detailed information than vague marketing terms such as waterproof.

IP65: No ingress of dust / Protected against low pressure jets of water.

IP66: No ingress of dust / Protected against powerful water jets.

IP67: No ingress of dust / Protected against harmful effects caused in 1M water within 30mins.

IP68: No ingress of dust / Protected against harmful effects caused in 1M water within 24hrs.

IP68 (Micro USB) : No ingress of dust / Protected against harmful effects caused in 1M water within 2hrs.

.....

∟ **Waterproof mated / unmated**

Mated Waterproof:

Waterproof is only assured when mated & locked tightly to its counterpart.

Unmated Waterproof:

Standalone waterproof or waterproof is assured even without its counterpart. The water will not get through the inner portion of the exposed connector as it is entirely sealed.

.....

∟ **UV Resistance**

Being resistant to ultra violet (UV) light or sunlight. UV light, or sunlight, will cause non-resistant materials and surfaces to fade or discolor.

.....

∟ **IEC**

Founded in 1906, the IEC (International Electrotechnical Commission) is the world's leading organization for the preparation and publication of International Standards for all electrical, electronic and related technologies. These are known collectively as "electrotechnology".

IEC provides a platform to companies, industries and governments for meeting, discussing and developing the International Standards they require. All IEC International Standards are fully consensus-based and represent the needs of key stakeholders of every nation participating in IEC work. Every member country, no matter how large or small, has one vote and a say in what goes into an IEC International Standard.

.....

∟ **UL 1977**

These requirements cover single and multipole connectors, intended for factory assembly to copper or copper alloy conductors or printed wiring boards, for use in data, signal, control and power applications within and between electrical equipment.

↳ ODVA

Founded in 1995, ODVA is a global association whose members are comprised of the world's leading automation companies. ODVA's mission is to advance open, interoperable information and communication technologies in industrial automation. ODVA recognizes its media independent network protocol, the Common Industrial Protocol or "CIP" – and the network adaptations of CIP – EtherNet/IP, DeviceNet, CompoNet and ControlNet – as its core technology and the primary common interest of its membership. ODVA's vision is to contribute to the sustainability and prosperity of the global community by transforming the model for information and communication technology in the industrial ecosystem.

- ALTW ODVA connectors on P8-11

↳ NMEA 2000

NMEA 2000 is a protocol used to create a network of electronic devices—chiefly marine instruments—on a boat. Various instruments that meet the NMEA 2000 standard are connected to one central cable, known as a backbone. The backbone powers each instrument and relays data among all of the instruments on the network. This allows one display unit to show many different types of information. It also allows the instruments to work together, since they share data. NMEA 2000 is meant to be "plug and play" to allow devices made by different manufacturers to talk and listen to each other.

- ALTW NMEA2000 connectors on P14-1

↳ Industrial Automation New Products

ALTW offers these all new Product features to IA and keeps on working at its best to satisfy the industries continuously growing field of applications:

- * M8/M12 Improved Cable Assy. with Hex nuts, overall molded connector and UL approved cables (for UL / CSA by Q2 2014)
- * M8/M12 Ruggedized Distribution Boxes (for UL / CSA by Q4 2013)
- * M12 High-Speed 8Pin (Up to 10GB Ethernet Application)
- * M8 / M12 Field Installable in IDC Contacts (Pressed-In Conn.)

↳ Amphenol LTW's X-Lok waterproof connector

"Click" when locking, for effort-saving and speed up. ALTW has X-Lok version for "3 Point Lock".

- ALTW X-Lok connectors on P20-1

↳ Amphenol LTW's 3 Point Lock waterproof connector

To enhance the efficiency and improve the stability of Mating with Lock function, ALTW has the 3 Point Lock design to have better connector mating function.

ALTW provides Cable-to-Cable currently.

∟ **Amphenol LTW's RBL waterproof connector**

Audible "Click" when locking; push both sides of the "Snap Lock" when unlocking. The creative design is effort-saving and speeds up the traditional connector locking nut function; furthermore, "Dual Snap Lock" is durable and protects from accidental loosening.

- ALTW RBL connectors on P19-1
-

∟ **Amphenol LTW waterproof connector : Mating with lock**

"Secured connector mating" product locking mechanisms provides complete connector fastening for assured continuous transmission and reliable waterproof function.

- ALTW Power connector (PWII): P2-13 / P2-14
 - ALTW VTC I T-Junction PT: P15-10
 - ALTW VTC I SMC: P15-10
 - ALTW BMC: P15-13
 - Cable Joiner: P21-26
-

∟ **Amphenol LTW's Hybrid waterproof connector**

A connector that contains contacts for more than one type of service. Note: Examples of hybrid connectors are those that have contacts for both optical fibers and twisted pairs, electric power and twisted pairs, or shielded and unshielded twisted pairs.

- ALTW Hybrid connectors
Circular series: P1-1
(5A+2A / 10A+2A / 10A+5A / 20A+2A / 20A+5A)
Power series: P2-1
(20A+2A)

Appendix

Standard Cable List

Product Series	Item No.	Jacket	Color	UL No.	Cable Spec.	Cable OD	Note
Circular	WCA0487UV01	PVC	Black	UL2464	26AWG*4C+Drain+AL.Mylar	4.8	Circular Mini Size / 2A / 4pin
Circular	WCA0486UV01	PVC	Black	UL2464	26AWG*5C+Drain+AL.Mylar	4.8	Circular Mini Size / 2A / 5pin
Circular	WCA0540UV01	PVC	Black	UL2464	26AWG*6C+Drain+AL.Mylar	5.0	Circular Mini Size / 2A / 6pin
Circular	WCA0072UV01	PVC	Black	UL2464	24AWG*2C+Drain+AL.Mylar	4.2	Circular Mini Size / 5A / 2pin Circular Standard Size / 5A / 2pin
Circular	WCA0549UV01	PVC	Black	UL2464	24AWG*3C+Drain+AL.Mylar	4.5	Circular Mini Size / 5A / 3pin Circular Standard Size / 5A / 3pin
Circular	WCA0219UV01	PVC	Black	UL2464	24AWG*4C+Drain+AL.Mylar	5.8	Circular Mini Size / 2A / 4pin Circular Standard Size / 5A / 4pin
Circular	WCA0217UV01	PVC	Black	UL2464	24AWG*6C+Drain+AL.Mylar	5.8	Circular Mini Size / 2A / 6pin Circular Standard Size / 5A / 6pin
Circular	WCA0543UV01	PVC	Black	UL2464	26AWG*10C+Drain+AL.Mylar	6.0	Circular Standard Size / 2A / 10pin
Circular	WCA0544UV01	PVC	Black	UL2464	26AWG*12C+Drain+AL.Mylar	6.0	Circular Standard Size / 2A / 12pin
Circular	WCA00010897	PVC	Black	UL1277,UL1581&UL83	18AWG*3C	8.5	Circular Standard Size / 5A / 3pin
Circular	WCA00010898	PVC	Black	UL1277,UL1581&UL83	18AWG*4C	9.2	Circular Standard Size / 5A / 4pin
Circular	WCA0551UV01	PVC	Black	UL2464	24AWG*5C+Drain+AL.Mylar	5.0	Circular Standard Size / 5A / 5pin
Circular	WCA0124UV01	PVC	Black	UL2464	20AWG*2C+Drain+AL.Mylar	5.8	Circular Standard Size / 10A / 2pin
Circular	WCA0489UV01	PVC	Black	UL2464	20AWG*3C+AL.Mylar	5.0	Circular Standard Size / 10A / 3pin
Circular	WCA0584UV01	PVC	Black	UL2464	26AWG*6C+24AWG*2C+Drain+AL.Mylar	5.5	Circular Standard Size / 5A+2A / 8pin
Circular	WCA0585UV01	PVC	Black	UL2464	24AWG*4C+20AWG*2C+Drain+AL.Mylar	6.0	Circular Standard Size / 10A+5A / 6pin
Circular	WCA0087UV01	PVC	Black	UL2464	24AWG*7C+Drain+AL/Mylar	5.8	Circular Standard Size / 5A / 7pin Circular Middle Size / 5A / 7pin
Circular	WCA0003UV01	PVC	Black	UL2464	24AWG*8C+Drain+AL/Mylar	5.5	Circular Standard Size / 5A / 8pin Circular Middle Size / 5A / 8pin
Circular	WCA0575UV01	PVC	Black	UL2464	20AWG*4C+Drain+AL.Mylar	5.5	Circular Standard Size / 10A / 4pin Circular Middle Size / 10A / 4pin
Circular	WCA0528UV01	PVC	Black	UL2464	24AWG*9C+Drain+AL.Mylar	6.0	Circular Middle Size / 5A / 9pin
Circular	WCA0556UV01	PVC	Black	UL2464	24AWG*10C+Drain+AL.Mylar	6.5	Circular Middle Size / 5A / 10pin
Circular	WCA0557UV01	PVC	Black	UL2464	24AWG*12C+Drain+AL.Mylar	7.0	Circular Middle Size / 5A / 12pin Circular Middle Size / 5A+2A / 12pin
Circular	WCA0558UV01	PVC	Black	UL2464	24AWG*14C+Drain+AL.Mylar	7.0	Circular Middle Size / 5A / 14pin Circular Middle Size / 5A+2A / 14pin
Circular	WCA0576UV01	PVC	Black	UL2464	20AWG*5C+Drain+AL.Mylar	6.0	Circular Middle Size / 10A / 5pin
Circular	WCA0577UV01	PVC	Black	UL2464	20AWG*6C+Drain+AL.Mylar	6.5	Circular Middle Size / 10A / 6pin
Circular	WCA00010710	PVC	Black	UL2464	(2P*24AWG+Drain+AL)+3C*16AWG+Filler+Pa per	12.0	Circular Middle Size / 10A+2A / 8pin
Circular	WCA0042UV01	PVC	Black	UL2464	24AWG*6C+20AWG*2C+Drain+AL.Mylar	6.0	Circular Middle Size / 10A+5A / 8pin Circular Others / 10A+5A / 8pin
Circular	WCA0560UV01	PVC	Black	UL2464	24AWG*18C+Drain+AL.Mylar	8.0	Circular Middle Size / 2A / 18pin Circular Large Size / 5A / 18pin
Circular	WCA0264UV01	PVC	Black	UL2464	16AWG*2C+Talcum	5.8	Circular Middle Size / 20A / 2pin Circular Large Size / 20A / 2pin
Circular	WCA0579UV01	PVC	Black	UL2464	16AWG*3C+Drain+AL.Mylar	7.5	Circular Middle Size / 20A / 3pin Circular Large Size / 20A / 3pin
Circular	WCA00010045	PVC	Black	UL2464	26AWG*22C+Drain+AL.Mylar	7.5	Circular Large Size / 2A / 20~22pin
Circular	WCA0285UV01	PVC	Black	UL2464	16AWG*4C+AL.Mylar	7.5	Circular Large Size / 20A / 4pin
Circular	WCA0263UV01	PVC	Black	UL2464	16AWG*5C+Talcum	7.8	Circular Large Size / 20A / 5pin
Circular	WCA0582UV01	PVC	Black	UL2464	16AWG*6C+Filler+Drain+AL.Mylar	9.5	Circular Large Size / 20A / 6pin
Circular	WCA0583UV01	PVC	Black	UL2464	16AWG*7C+Drain+AL.Mylar	9.5	Circular Large Size / 20A / 7pin
Circular	WCA00010876	PVC	Black	UL2586	(24AWG*1P+A)*2C+16AWG*3C+EA	10.0	Circular Large Size / 20A+2A / 8pin
Circular	WCA00010635	PVC	Black	UL2464	(24AWG*4P+Drain+AL)+16AWG*3C+Filler+Pa per	11.0	Circular Large Size / 20A+5A / 12pin
Circular	WCA0449UV01	PVC	Black	UL2464	26AWG*31C+Drain+AL.Mylar	9.0	Circular Macro Size / 5A / 31pin
Circular	WCA0577UV01	PVC	Black	UL2464	20AWG*6C+Drain+AL.Mylar	6.5	Circular RBL / 5A / 6pin
Circular	WCA0485XX01	PVC	Black	UL2464	14AWG*3C+Talcum	7.0	Circular X-Lock / 20A / 3pin

* Design and specification are subject to change without notice.

Appendix

Standard Cable List

Product Series	Item No.	Jacket	Color	UL No.	Cable Spec.	Cable OD	Note
Power	WCA0576UV01	PVC	Black	UL2464	20AWG*5C+Drain+AL.Mylar	6.0	Power / 8A / 5pin
Power	WCA0577UV01	PVC	Black	UL2464	20AWG*6C+Drain+AL.Mylar	6.5	Power / 8A / 6pin
Power	WCA00010049	PVC	Black	UL2464	20AWG*7C+Drain+AL.Mylar	6.5	Power / 8A / 7pin
Power	WCA0264UV01	PVC	Black	UL2464	16AWG*2C+Talcum	5.8	Power / 12A / 2pin
Power	WCA0579UV01	PVC	Black	UL2464	16AWG*3C+Drain+AL.Mylar	7.5	Power / 12A / 3pin
Power	WCA0285UV01	PVC	Black	UL2464	16AWG*4C+AL.Mylar	7.5	Power / 12A / 4pin
Power	WCA0485XX01	PVC	Black	UL2464	14AWG*3C+Talcum	7.0	Power / 20A / 3pin
Power	WCA00010846	PVC	Black	UL1277,UL1581&UL83	14AWG*3C	9.7	Power / 20A / 3pin
Power	WCA0579UV01	PVC	Black	UL2464	16AWG*3C+Drain+AL.Mylar	7.5	Power / 20A+2A / 4pin
Power	WCA00010899	PVC	Black	UL1277,UL1581,UL83	14AWG*3C+16AWG*1C	10.3	Power / 20A+2A / 4pin
Power	WCA00010239	PVC	Black	-	SJT 10AWG*3C+Talc	15.6	Power / 25A / 3pin
Sensor	WCA0570UV01	PVC	Black	UL2464	22AWG*3C+Talcum	5.0	Sensor M8 / 5A / 3pin
Sensor	WCA00010063	PU	Black	NONUL	22AWG*3C+Talcum	4.5	Sensor M8 / 5A / 3pin
Sensor	WCA0571UV01	PVC	Black	UL2464	22AWG*4C+Talcum	5.0	Sensor M8 / 5A / 4pin
Sensor	WCA00010062	PU	Black	NONUL	22AWG*4C+Insulation	4.8	Sensor M8 / 5A / 4pin
Sensor	WCA0027UV01	PVC	Black	UL2464	24AWG*2C+Talcum	4.2	Sensor M10.5 / 2A / 2pin
Sensor	WCA0006UV01	PVC	Black	UL2464	24AWGx3C+Talcum	4.5	Sensor M10.5 / 2A / 3pin
Sensor	WCA0036UV01	PVC	Black	UL2464	24AWG*4C+Talcum	5.0	Sensor M10.5 / 2A / 4pin
Sensor	WCA0229UV01	PVC	Black	UL2464	24AWG*5C+Talcum	5.0	Sensor M10.5 / 2A / 5pin
Sensor	WCA0570UV01	PVC	Black	UL2464	22AWG*3C+Talcum	5.0	Sensor M12 / 5A / 3pin
Sensor	WCA00010063	PU	Black	NONUL	22AWG*3C+Talcum	4.5	Sensor M12 / 5A / 3pin
Sensor	WCA0571UV01	PVC	Black	UL2464	22AWG*4C+Talcum	5.0	Sensor M12 / 5A / 4pin
Sensor	WCA00010062	PU	Black	NONUL	22AWG*4C+Insulation	4.8	Sensor M12 / 5A / 4pin
Sensor	WCA0521UV01	PVC	Black	UL2464	22AWG*5C+Talcum	5.5	Sensor M12 / 5A / 5pin
Sensor	WCA00010061	PU	Black	NONUL	22AWG*5C+Filler+Talcum+Paper	5.0	Sensor M12 / 5A / 5pin
Sensor	WCA0203UV01	PVC	Black	UL2464	24AWG*8C+Talcum	5.5	Sensor M12 / 2A / 8pin
Sensor	WCA00010060	PU	Black	NONUL	24AWG*8C+Paper+Filler	6.0	Sensor M12 / 2A / 8pin
Sensor	WCA00010209	PVC	Black	UL2464	22AWG*3C+Drain+AL.Mylar	4.5	Sensor M12 Shielded / 5A / 3pin
Sensor	WCA00010139	PU	Black	NONUL	22AWG*3C+Drain+AL.Mylar	4.5	Sensor M12 Shielded / 5A / 3pin
Sensor	WCA0568UV01	PVC	Black	UL2464	22AWG*4C+Drain+AL.Mylar	5.5	Sensor M12 Shielded / 5A / 4pin
Sensor	WCA00010140	PU	Black	NONUL	22AWG*4C+Drain+AL.Mylar	4.5	Sensor M12 Shielded / 5A / 4pin
Sensor	WCA0569UV01	PVC	Black	UL2464	22AWG*5C+Drain+AL.Mylar	5.5	Sensor M12 Shielded / 5A / 5pin
Sensor	WCA00010141	PU	Black	NONUL	22AWG*5C+AL.Mylar+Drain	5.2	Sensor M12 Shielded / 5A / 5pin
Sensor	WCA0003UV01	PVC	Black	UL2464	24AWG*8C+Drain+AL/Mylar	5.5	Sensor M12 Shielded / 2A / 8pin
Sensor	WCA00010142	PU	Black	NONUL	24AWG*8C+Drain+AL.Mylar	5.5	Sensor M12 Shielded / 2A / 8pin
Sensor	WCA0352XX02	PU	Black	NONUL	22AWG*5C+Talcum	5.0	Sensor M12 Y Cable / 5A / 5pin
Sensor	WCA0251XX02	PU	Black	NONUL	24AWG*8C+Paper	5.2	Sensor M12 Y Cable / 2A / 8pin
USB	WCA0365UV01	PVC	Black	-	28AWG*1P+24AWG*2C+AL.Mylar+Drain+Braid (USB 2.0)	5.0	USB / 2.0
IEEE 1394	WCA00010037	PVC	Black	-	(28AWG*1P+AL+B)*2+22AWG*2C+Tran.Mylar+AL+B	6.5	IEEE 1394
D-SUB	WCA0528UV01	PVC	Black	UL2464	24AWG*9C+Drain+AL.Mylar	6.0	D-SUB Standard / 09pin
D-SUB	WCA0465UV01	PVC	Black	UL2464	24AWG*15C+Drain+AL.Mylar	7.0	D-SUB Standard / 15pin
D-SUB	WCA0284UV01	PVC	Black	UL2464	24AWG*25C+Drain+AL.Mylar	9.0	D-SUB Standard / 25pin
D-SUB	WCA00010114	PVC	Black	UL2464	24AWG*37C+Drain+AL/Mylar	8.5	D-SUB Standard / 37pin
D-SUB	WCA00010080	PVC	Black	UL2464	(24AWG*25C+Mylar)+24AWG*25C+Drain+AL.Mylar	12.0	D-SUB Standard / 50pin
D-SUB	WCA0545UV01	PVC	Black	UL2464	26AWG*15C+Drain+AL.Mylar	6.5	D-SUB High Density / 15pin
D-SUB	WCA0546UV01	PVC	Black	UL2464	26AWG*26C+Drain+AL.Mylar	8.0	D-SUB High Density / 26pin
D-SUB	WCA0547UV01	PVC	Black	UL2464	26AWG*44C+Drain+AL.Mylar	10.5	D-SUB High Density / 44pin
D-SUB	WCA00010115	PVC	Black	UL2464	(26AWG*31C+Mylar)+26AWG*31C+Drain+AL/Mylar	13.0	D-SUB High Density / 62pin
D-SUB	WCA00010081	PVC	Black	UL2464	((28AWG*28C+Mylar)+28AWG*22C+Mylar)+28AWG*28C+Drain+AL	13.0	D-SUB High Density / 78pin

Product Series	Item No.	Jacket	Color	UL No.	Cable Spec.	Cable OD	Note
DVI	WCA00010095	PVC	Black	UL20276	(28AWG* 1P+Drain+AL+Mylar)* 4C+(1P+3C)* 28AWG+AL+Braid	7.3	DVI / 19pin
DVI	WCA00010096	PVC	Black	UL20276	[3COAX+(1P* 28AWG+Drain+AL.Mylar+Mylar)* 4+ 1P* 28#+6C* 28AWG]+AL.Mylar+Braid	8.5	DVI / 23pin
DVI	WCA00010097	PVC	Black	UL20276	(28AWG* 1P+Drain+AL+Mylar)* 7C+28AWG* 1P+28AWG* 3C+AL+Braid	8.5	DVI / 25pin
DVI	WCA00010098	PVC	Black	UL20276	[3COAX+(28AWG* 1P+Drain+AL+Mylar)* 7+28AWG* 1P+28AWG* 6C]+AL+Braid	10.0	DVI / 29pin
RJ	WCA0663UV01	PVC	Black	-	CAT.5E UTP 24AWG* 4P	6.0	RJ / Cat.5E
RJ	WCA0664UV01	PVC	Black	-	CAT.5E FTP 24AWG* 4P+Mylary+D+AL/Mylar	6.5	RJ / Cat.5E
RJ	WCA00010356	PVC	Black	-	CAT.5E FTP 24AWG* 5P+Mylar+Drain+AL.Mylar	6.5	RJ / Cat.5E
HDMI	WCA00010264	PVC	Black	UL20276	(26AWG* 1P+Drain+AL+Mylar)* 4C+26AWG* 1P+26AWG* 5C+AL+Braid	8.5	HDMI / 19pin
NMEA	WCA00010257	PVC	Black	-	{(24AWG+ 1P+AL)+(22AWG+ 1P+AL)}+Drain+AL.Mylar+Braid	6.0	NMEA / 4A / 5pin
NMEA	WCA00010258	PVC	Black	-	{(22AWG+ 1P+AL)+(18AWG+ 1P+AL)}+Drain+AL.Mylar+Braid	7.0	NMEA / 4A / 5pin
NMEA	WCA00010437	PVC	Gray	-	{(24AWG+ 1P+AL)+(22AWG+ 1P+AL)}+Drain+Braid+Mylar	7.1	NMEA / 4A / 5pin
NMEA	WCA00010369	PVC	Black	-	STOOW 16AWG* 4C	10.6	NMEA / 8A / 4pin
NMEA	WCA00010259	PVC	Black	UL20276	{(18AWG* 1P+AL)+(16AWG* 1P+AL)}+Drain+AL+Braid	10.0	NMEA / 8A / 5pin
NMEA	WCA00010436	PVC	Gray	-	{(18AWG+ 1P+AL)+(15AWG+ 1P+AL)}+Drain+Braid	12.2	NMEA / 8A / 5pin
Coaxial	WCA0033XX01	PVC	Black	-	20AWG,RG-58 /U1	5.0	Coaxial / 50Ω
Coaxial	WCA0009XX04	PVC	Black	-	RG-59U 1C+Braid	6.15	Coaxial / 75Ω
Coaxial	WCA0445XX01	PVC	Black	UL1185	26AWG* 1C+Spiral	3.0	Coaxial / RCA
DC-JACK	WCA0072UV01	PVC	Black	UL2464	24AWG* 2C+Drain+AL.Mylar	4.2	DC-JACK / 2pin, 14pin
DC-JACK	WCA0549UV01	PVC	Black	UL2464	24AWG* 3C+Drain+AL.Mylar	4.5	DC-JACK
KSZ Circular	WCA00010022	PVC	Black	UL2464	18AWGx2C+AL.Mylar	5.5	KSZ Circular / 10A / 2pin
KSZ Circular	WCA0242XX01	PVC	Black	UL2464	18AWG* 3C+AL.Mylar	6.0	KSZ Circular / 10A / 3pin
KSZ Circular	WCA0416XX01	PVC	Black	UL2464	18AWG* 4C+Drain+AL.Mylar	6.5	KSZ Circular / 10A / 4pin
Low Profile	WCA0542UV01	PVC	Black	UL2464	26AWG* 8C+Drain+AL.Mylar	5.5	Low Profile / 1A / 8pin
Low Profile	WCA0543UV01	PVC	Black	UL2464	26AWG* 10C+Drain+AL.Mylar	6.0	Low Profile / 1A / 10pin
Mini Din	WCA0487UV01	PVC	Black	UL2464	26AWG* 4C+Drain+AL.Mylar	4.8	Mini Din / 4pin
Mini Din	WCA0486UV01	PVC	Black	UL2464	26AWG* 5C+Drain+AL.Mylar	4.8	Mini Din / 5pin
Mini Din	WCA0540UV01	PVC	Black	UL2464	26AWG* 6C+Drain+AL.Mylar	5.0	Mini Din / 6pin
Mini Din	WCA0541UV01	PVC	Black	UL2464	26AWG* 7C+Drain+AL.Mylar	5.0	Mini Din / 7pin
Mini Din	WCA0542UV01	PVC	Black	UL2464	26AWG* 8C+Drain+AL.Mylar	5.5	Mini Din / 8pin
Solar	WCA00010897	PVC	Black	UL1277,UL1581&UL83	18AWG* 3C	8.5	Solar / 3pin
Solar	WCA00010898	PVC	Black	UL1277,UL1581&UL83	18AWG* 4C	9.2	Solar / 4pin
Solar	WCA00010894	PVC	Black	UL1277,UL1581&UL83	12AWG* 3C	11.0	Solar / 17A / 3pin
Solar	WCA00010895	PVC	Black	UL1277,UL1581&UL83	12AWG* 4C	12.0	Solar / 17A / 4pin
Solar	WCA00010373	TPE-U	Black	-	12AWG* 1C	6.5	Solar / 1Pin
Solar	WCA00010593	XLPO	Black	-	12AWG* 1C	6.1	Solar / 1Pin
Solar	WCA00010750	XLPO	Black	-	12AWG* 1C	6.3	Solar / 1Pin
Solar	WCA00010430	XLPO	Black	-	12AWG* 1C	6.8	Solar / 1Pin

* Design and specification are subject to change without notice.

∟ Maximum Wire Copper OD Size

Product Series	Categories	Sub-Categories	Solder Pin: Maximum Copper OD within allowed current rating (Unit: mm)	Screw Pin: Maximum Copper OD within allowed current rating (Unit: mm)
Circular Connectors	Mini (A) - Size	AD	1.00	-
Circular Connectors	Mini (A) - Size	AU	0.80	-
Circular Connectors	Standard (B) - Size	BB	1.30	-
Circular Connectors	Standard (B) - Size	BD	1.00	-
Circular Connectors	Standard (B) - Size	BB	1.30	-
Circular Connectors	Standard (B) - Size	BBD	1.00	-
Circular Connectors	Standard (B) - Size	BD	1.00	-
Circular Connectors	Standard (B) - Size	BDU	1.00	-
Circular Connectors	Standard (B) - Size	BU	0.80	-
Circular Connectors	Middle (C) - Size	CBU	1.3/0.8	-
Circular Connectors	Middle (C) - Size	CB	1.30	-
Circular Connectors	Middle (C) - Size	CC	1.70	2.00
Circular Connectors	Middle (C) - Size	CD	1.00	-
Circular Connectors	Middle (C) - Size	CU	0.80	-
Circular Connectors	Middle (C) - Size	CDU	1.0/0.8	-
Circular Connectors	Large (D) - Size	DCD	1.7/1.0	-
Circular Connectors	Large (D) - Size	DCU	1.7/0.8	-
Circular Connectors	Large (D) - Size	DC	1.70	2.00
Circular Connectors	Large (D) - Size	DD	1.00	-
Circular Connectors	Large (E) - Size	ED	1.00	-
M Series Sensor Connectors	M8	8P	0.80	-
M Series Sensor Connectors	M12	12,12B,12D,12B,SBP,SDP	1.00	1.10
M Series Sensor Connectors	M20	HB20,HC20,HD20,LB20,LC20,LD20	1.70	2.00
M Series Sensor Connectors	M23	LJ23	-	-
Power Connectors	20A+2A	PWCU	1.7/0.8	-
Power Connectors	30A	PWL	3.60	-
Power Connectors	30A	PWJ	-	2.60
Power Connectors	25A	PWH	2.60	-
Power Connectors	20A	PWC	1.70	-
Power Connectors	8A	PWE	1.20	1.10
Power Connectors	12A	PWF	1.60	1.60
Power Connectors	16A	PWG	2.00	2.00
NMEA 2000 Connectors	Micro	12,12P	1.00	-
D-SUB Connectors	Standard	SDB-09	1.00	-
D-SUB Connectors	Standard	SDB-15,SDB-25	1.00	-
D-SUB Connectors	Standard	SDB-15	1.00	-
D-SUB Connectors	High Density	HDB-15	1.00	-
D-SUB Connectors	High Density	HDB-26,HDB-44	1.00	-
D-SUB Connectors	High Density	HDB-26	1.00	-

☒ Cable Max. OD for Filed Installable

Product Series	Categories	Sub-Categories	Cable OD
Circular Connectors	Mini (A) - Size	AD,AU	4.5~6.5
Circular Connectors	Standard (B) - Size	BB,BD	3.5~6.5
Circular Connectors	Standard (B) - Size	BB,BBD,BD,BDU,BU	4.5~6.5
Circular Connectors	Middle (C) - Size	CBU	7.6~9.6
Circular Connectors	Middle (C) - Size	CB,CC,CD,CU,CDU	4.0~9.6
Circular Connectors	Large (D) - Size	DCD	10.0~12.4
Circular Connectors	Large (D) - Size	DCU	9.5~10.8
Circular Connectors	Large (D) - Size	DC,DD	9.5~10.8
Circular Connectors	Large (E) - Size	None	None
Circular Connectors	Other - Size	PLD	4.5~6.5
M Series Sensor Connectors	M8	8P	4.5~6.5
M Series Sensor Connectors	M12	12,12B,12D,12B,SBP,SDP	4.5~6.5
M Series Sensor Connectors	M20	HB20,HC20,HD20,LB20,LC20,LD20	5.5~12.5
M Series Sensor Connectors	M23	LJ23	8.5~17.5
Power Connectors	20A+2A	PWCU	4.0~9.6, 10~19
Power Connectors	30A	PWL	10~19
Power Connectors	30A	PWJ	9.0~12.0, 13~16
Power Connectors	25A	PWH	9.0~12.0, 13~16
Power Connectors	20A	PWC	4.0~9.6
Power Connectors	8A	PWE	5.5~10.8
Power Connectors	12A	PWF	5.5~10.8
Power Connectors	16A	PWG	6.0~12.5
USB Connectors	Mini USB 2.0 B Type	NUB	3.5~5.5
USB Connectors	USB 2.0 A Type	UA	5.0~10.8
USB Connectors	USB 2.0 B Type	UB	5.0~10.8
NMEA 2000 Connectors	Micro	12,12P	4.5~6.5
NMEA 2000 Connectors	Mini	MN	8.0~11.0
NMEA 2000 Connectors	Micro	UMC	4.5~7.5
NMEA 2000 Connectors	Mini	UMN	8~12.2
D-SUB Connectors	Standard	SDB-09	3.5~7.0
D-SUB Connectors	Standard	SDB-15,SDB-25	6.0~10.0
D-SUB Connectors	Standard	SDB-15	6.0~8.0
D-SUB Connectors	High Density	HDB-15	3.5~7.0
D-SUB Connectors	High Density	HDB-26,HDB-44	6.0~10.0
D-SUB Connectors	High Density	HDB-26	6.0~8.0
IEEE 1394 Connectors	IEEE 1394B	13-	6.0~10.0
Fiber Optic Connectors	LC Type	FB-	2.5~2.8, 4.5~6.8
Fiber Optic Connectors	SC Type	FB-	2.0~2.4
Cable Joiner	6~10mm	CX	6~10
Cable Joiner	8~10mm	CX	8~10
Cable Joiner	10~12mm	CX	10~12
Cable Joiner	12~16mm	CX	12~16
RJ Connector	-	RCP,RDP,ROP	4.5~6.5

* Design and specification are subject to change without notice.

Quick Search (Circular Connector)

▾ In-line

Size	Mating Style	Connector (Housing) Gender / Contact Gender	Overmolded with Cable / Field Installable	To	Mating Pair	Page
Mini Size (A) 7/16"-28 UNS	2 Points Lock	MM	Overmolded with Cable	To	Overmolded with Cable & Field Installable	1-14
		FF	Overmolded with Cable	To	Overmolded with Cable & Field Installable	1-14
Standard Size (B) 5/8"-27 UNS	2 Points Lock	MM	Overmolded with Cable	To	Overmolded with Cable & Field Installable	1-16
			Field Installable	To	Overmolded with Cable & Field Installable	1-16
		FF	Overmolded with Cable	To	Overmolded with Cable & Field Installable	1-17
			Field Installable	To	Overmolded with Cable & Field Installable	1-17
FM	Overmolded with Cable	To	Overmolded with Cable & Field Installable	1-18		
Middle Size (C) 13/16"-28 UNS	2 Points Lock	MM	Overmolded with Cable	To	Overmolded with Cable & Field Installable	1-22
			Field Installable	To	Overmolded with Cable & Field Installable	1-22
		FF	Overmolded with Cable	To	Overmolded with Cable & Field Installable	1-22
			Field Installable	To	Overmolded with Cable & Field Installable	1-23
		MF	Overmolded with Cable	To	Overmolded with Cable & Field Installable	1-23
		FM	Overmolded with Cable	To	Overmolded with Cable & Field Installable	1-23
Large Size (D) 1"-20UNEF	2 Points Lock	MM	Overmolded with Cable	To	Overmolded with Cable & Field Installable	1-29
		FF	Overmolded with Cable	To	Overmolded with Cable & Field Installable	1-29
		MF	Overmolded with Cable	To	Overmolded with Cable & Field Installable	1-29
		FM	Overmolded with Cable	To	Overmolded with Cable & Field Installable	1-30
		MD*	Overmolded with Cable	To	Overmolded with Cable & Field Installable	1-30
			Field Installable	To	Overmolded with Cable & Field Installable	1-30
		ME*	Overmolded with Cable	To	Overmolded with Cable & Field Installable	1-31
			Field Installable	To	Overmolded with Cable & Field Installable	1-31

* (E) Male (Power) + Female (Signal) | (D) Female (Power) + Male (Signal)

▾ Receptacle and Mating Pair

Size	Mating Style	Connector (Housing) Gender / Contact Gender	Receptacle / Receptacle with Overmolded Cable	To	Mating Pair	Page
Mini Size (A) 7/16"-28 UNS	Screw Thread / 2 Points Lock	MM	Receptacle	To	Overmolded with Cable & Field Installable	1-15
			Receptacle with Overmolded Cable	To	Overmolded with Cable & Field Installable	1-15
Standard Size (B) 5/8"-27 UNS	Screw Thread / 2 Points Lock	MM	Receptacle	To	Overmolded with Cable & Field Installable	1-19
			Receptacle with Overmolded Cable	To	Overmolded with Cable & Field Installable	1-20
Middle Size (C) 13/16"-28 UNS	Screw Thread / 2 Points Lock	MM	Receptacle	To	Overmolded with Cable & Field Installable	1-21
			Receptacle with Overmolded Cable	To	Overmolded with Cable & Field Installable	1-24
		MF	Receptacle	To	Overmolded with Cable & Field Installable	1-25
			Receptacle with Overmolded Cable	To	Overmolded with Cable & Field Installable	1-27
	3 Points Lock	MD*	Receptacle	To	Overmolded with Cable & Field Installable	1-28
		ME	Receptacle	To	Overmolded with Cable & Field Installable	1-28
Large Size (D) 1"-20UNEF	Screw Thread / 2 Points Lock	MM	Receptacle	To	Overmolded with Cable & Field Installable	1-32
		MF	Receptacle	To	Overmolded with Cable & Field Installable	1-33
	2 Points Lock	MD*	Receptacle	To	Overmolded with Cable & Field Installable	1-34
		ME*	Receptacle	To	Overmolded with Cable & Field Installable	1-34
Micro Size (E) 13/16"-20 UNS	2 Points Lock	MF	Receptacle	To	Overmolded with Cable & Field Installable	1-34

* (E) Male (Power) + Female (Signal) | (D) Female (Power) + Male (Signal)

Amphenol LTW Technology Co., Ltd. (Headquarter)

9F., No.657-12, Zhongzheng Rd., Xinzhuang Dist., New Taipei City 242, Taiwan
Telephone: +886-2-29085626 Fax: +886-2-29029787
www.amphenolltw.com

Shulin plant, Taiwan

No.10, Shutan St., Shulin Dist., New Taipei City 238, Taiwan

Kunshan plant, China

No. 62 Da Tung Road, Peng Lang Street, Kunshan City , Jiangsu Province, China
Telephone: +86-512-5761-0501
Fax: : +86-512-5761-0515

For further information, please contact :

Sales & Marketing Department | Email : sales@ltw-tech.com



Scan to visit our website